



SOMMERS

WOOD-N-DOOR INC

Quality Custom Woodworking

2023 Trim Catalog



SOMMERS

WOOD-N-DOOR INC



7890 Amish Pike • Plain City, Ohio

Phone: (614) 873-3506

Fax: (614) 873-3614

Email: sales@sommerswood.com

www.sommerswood.com

TABLE OF CONTENTS

[1] Casing.....	5
[2] Base.....	71
[3] Chair Rails, Bed, & Panel Moulding	125
[4] Back Band	175
[5] Crown.....	189
[6] Tongue & Groove, Plinth, & Handrail	281
[7] Door Stop.....	303
[8] Miscellaneous	307
[9] Bullnose	313

SECTION 1

Casing Profiles

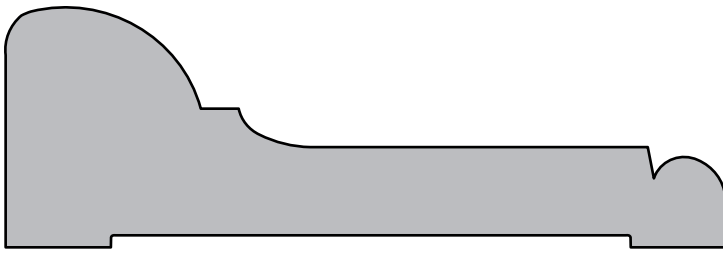

SWD 001 | $1\frac{1}{4}'' \times 3\frac{3}{4}''$

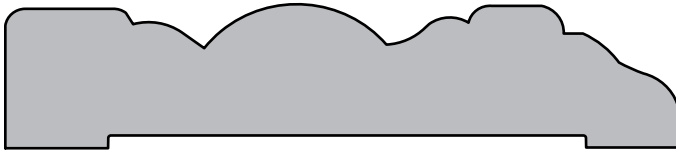

SWD 002 | $\frac{3}{4}'' \times 3\frac{1}{2}''$



SWD 003 | $\frac{3}{4}'' \times$ Customer Specs

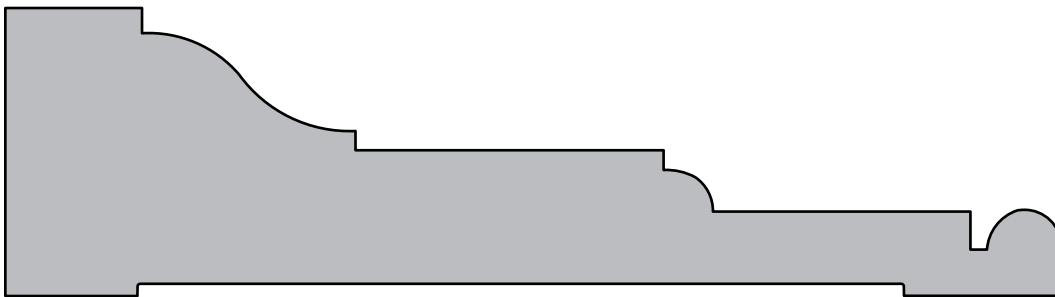

SWD 004 | $1\frac{1}{2}'' \times 5\frac{1}{2}''$

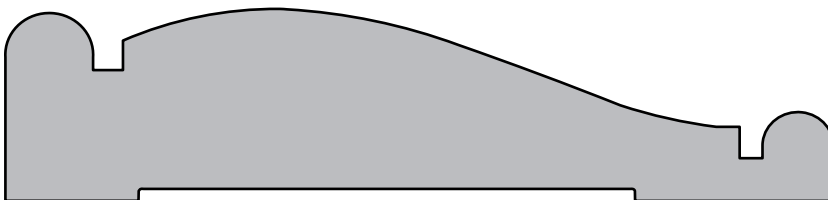

SWD 005 | $1'' \times 4\frac{5}{16}''$

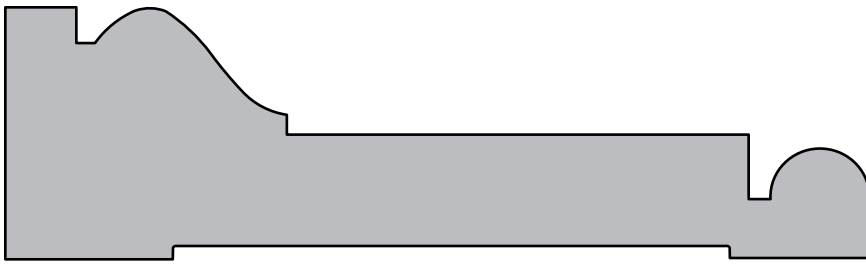

SWD 006 | $1\frac{5}{16}'' \times 4\frac{1}{2}''$

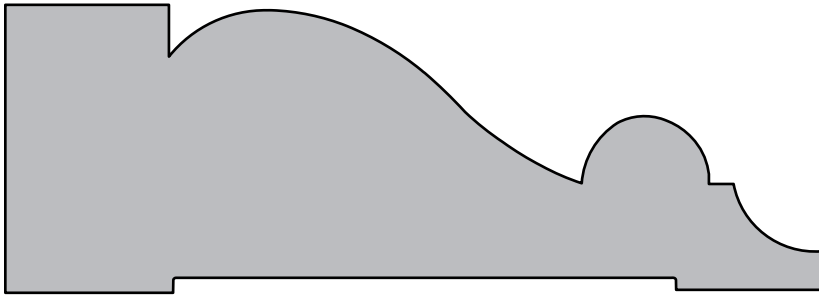

SWD 007 | $1\frac{1}{2}'' \times 4\frac{1}{4}''$

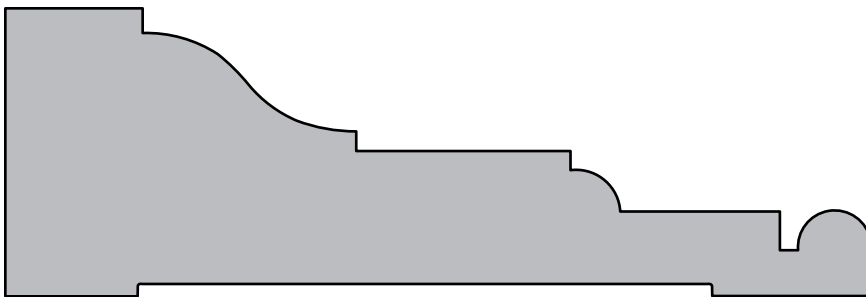

SWD 008 | $1\frac{1}{2}'' \times 4\frac{1}{2}''$



SWD 009 | $\frac{3}{4}'' \times$ Customer Specs

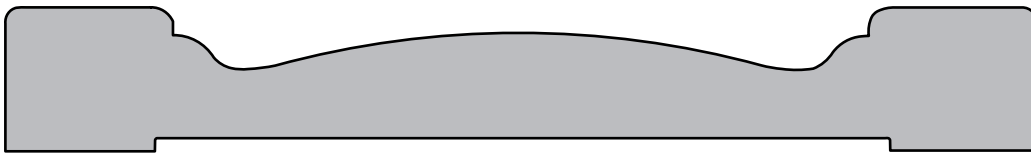

SWD 010 | $\frac{3}{4}'' \times 5\frac{3}{8}''$

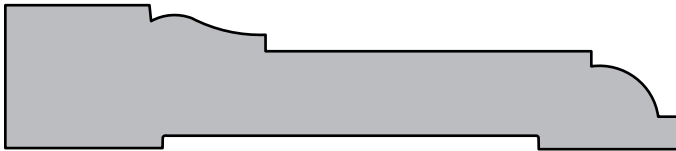

SWD 011 | $\frac{3}{4}'' \times 3\frac{1}{2}''$

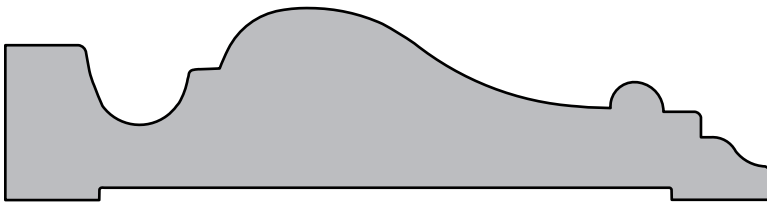

SWD 012 | $1'' \times 4''$

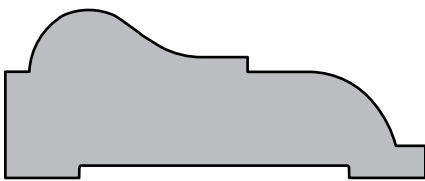

SWD 013 | $\frac{7}{8}'' \times 2\frac{3}{16}''$

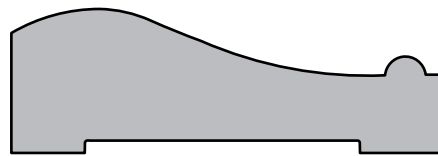

SWD 014 | $\frac{3}{4}'' \times 2\frac{1}{4}''$



SWD 015 | $\frac{3}{4}'' \times 3\frac{1}{2}''$

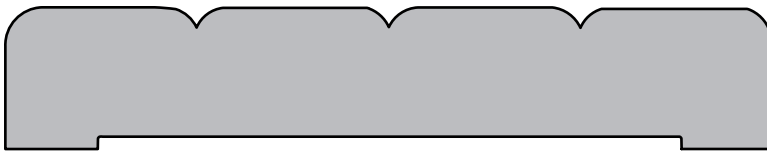

SWD 016 | $\frac{3}{4}'' \times 4''$

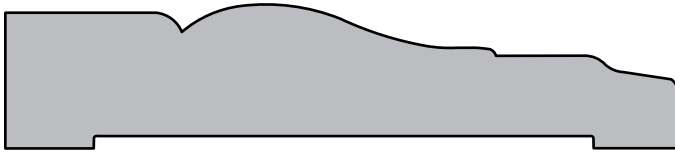

SWD 017 | $\frac{3}{4}'' \times 3\frac{1}{2}''$

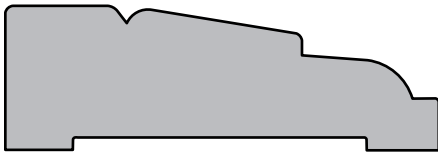

SWD 018 | $\frac{3}{4}'' \times 2\frac{1}{4}''$

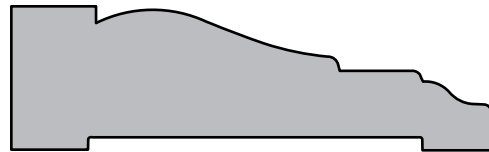

SWD 019 | $\frac{3}{4}'' \times 2\frac{1}{2}''$

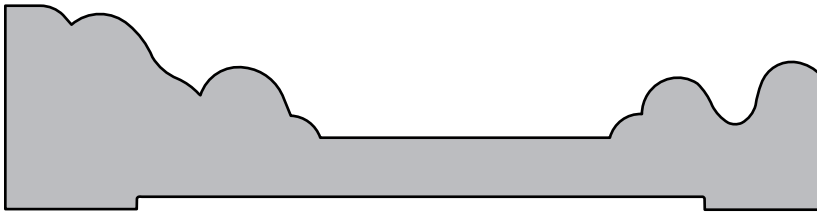

SWD 020 | $1\frac{1}{16}'' \times 4\frac{3}{16}''$

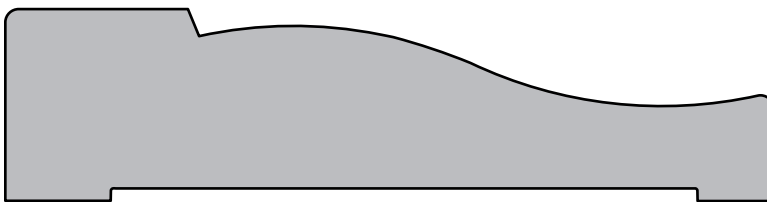

SWD 021 | $1'' \times 4''$

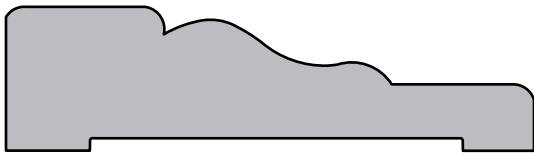

SWD 022 | $\frac{3}{4}'' \times 2\frac{3}{4}''$

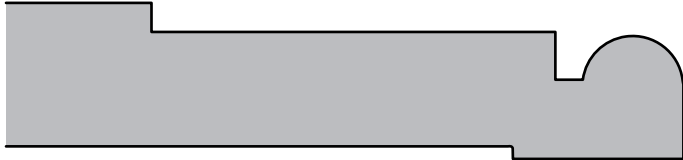

SWD 023 | $\frac{13}{16}'' \times$ Customer Specs



SWD 024 | $\frac{7}{8}'' \times 4''$

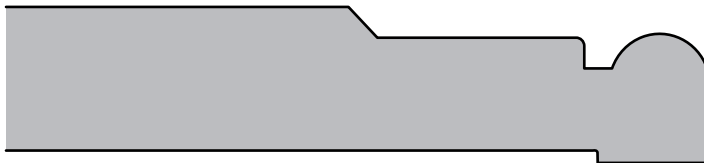

SWD 025 | $\frac{3}{4}'' \times$ Customer Specs

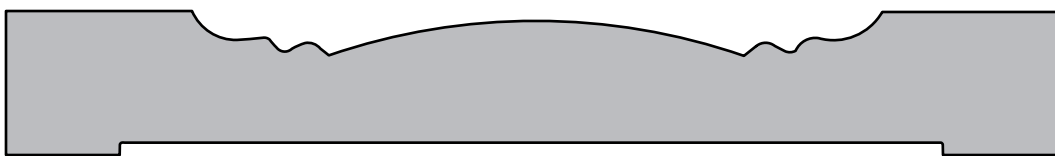

SWD 026 | $\frac{3}{4}'' \times 5\frac{1}{2}''$

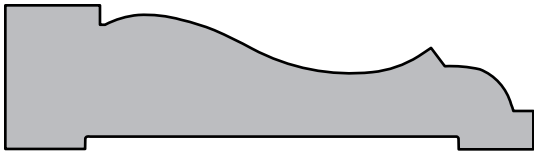

SWD 027 | $\frac{3}{4}'' \times 2\frac{3}{4}''$

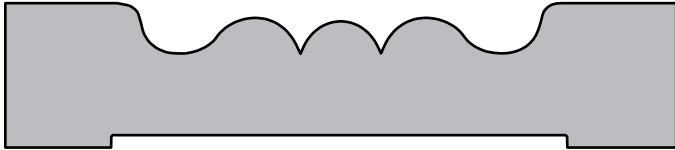

SWD 028 | $\frac{3}{4}'' \times 3\frac{1}{2}''$



SWD 029 | $\frac{3}{4}'' \times 2\frac{1}{2}''$

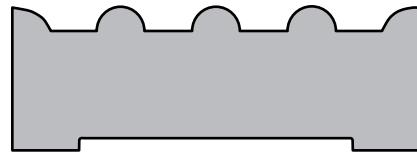

SWD 030 | $\frac{3}{4}'' \times 2\frac{1}{8}''$



SWD 031 | $\frac{3}{4}'' \times$ Customer Specs



SWD 032 | $\frac{3}{4}'' \times$ Customer Specs



SWD 033 | $\frac{3}{4}'' \times 3\frac{1}{2}''$



SWD 034 | $1\frac{1}{4}'' \times 4\frac{7}{8}''$

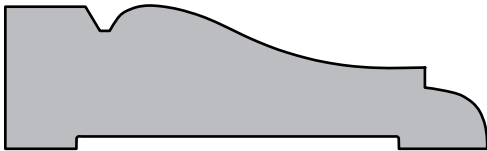

SWD 035 | $\frac{3}{4}'' \times 2\frac{1}{2}''$

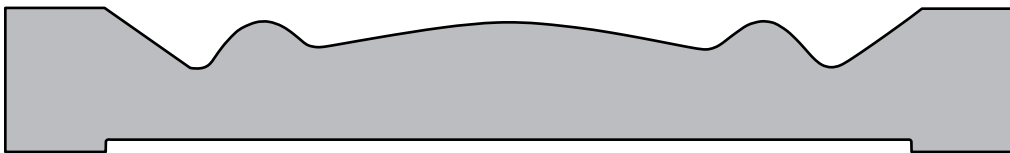

SWD 036 | $\frac{3}{4}'' \times 5\frac{1}{4}''$

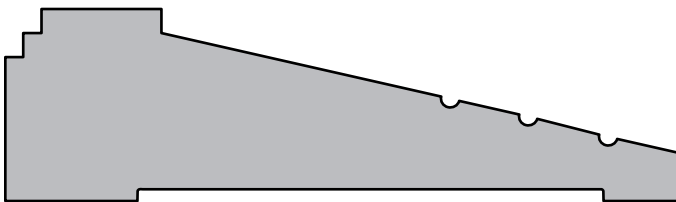

SWD 037 | $1'' \times 3\frac{1}{2}''$

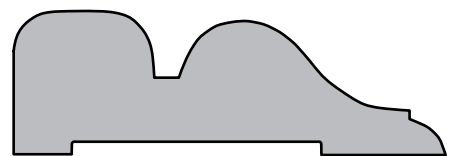

SWD 038 | $\frac{3}{4}'' \times 2\frac{1}{4}''$



SWD 039 | $\frac{3}{4}$ " x Customer Specs

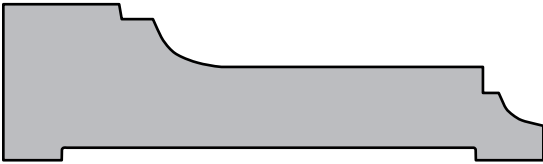

SWD 040 | $1\frac{3}{16}$ " x $2\frac{13}{16}$ "

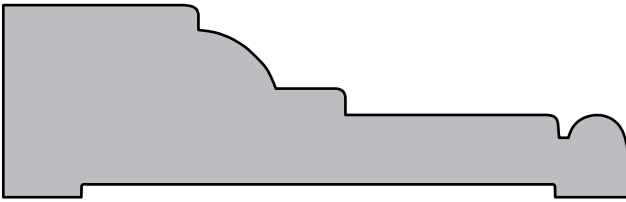

SWD 041 | 1" x $3\frac{1}{4}$ "



SWD 042 | $\frac{3}{4}$ " x 4"



SWD 043 | $\frac{3}{4}$ " x $3\frac{1}{2}$ "

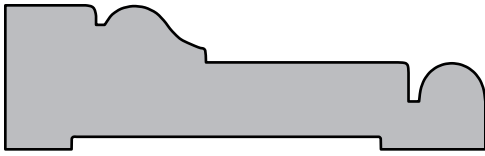

SWD 044 | $\frac{3}{4}'' \times 2\frac{1}{2}''$

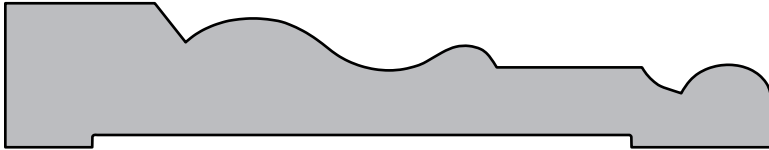

SWD 045 | $\frac{3}{4}'' \times 4''$



SWD 046 | $\frac{3}{4}'' \times 3''$



SWD 047 | $\frac{3}{4}'' \times 3\frac{1}{2}''$



SWD 048 | $\frac{3}{4}'' \times 5\frac{1}{4}''$

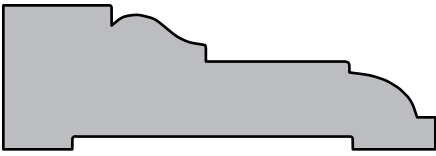

SWD 049 | $\frac{3}{4}'' \times 2\frac{1}{4}''$



SWD 050 | $\frac{3}{4}'' \times$ Customer Specs



SWD 051 | $1\frac{3}{16}'' \times 4\frac{3}{8}''$



SWD 052 | $1\frac{3}{16}'' \times 4''$

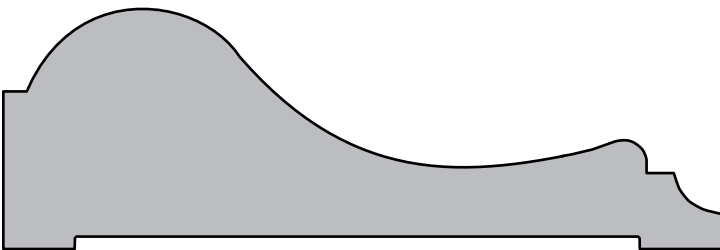

SWD 053 | $1\frac{1}{4}'' \times 3\frac{3}{4}''$



SWD 054 | $1\frac{3}{16}'' \times 3\frac{1}{2}''$

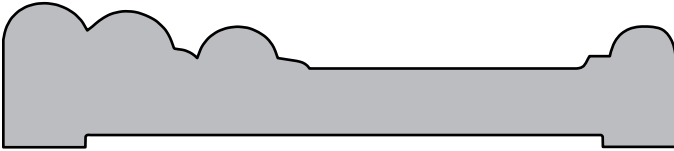

SWD 055 | $\frac{3}{4}'' \times 3\frac{1}{2}''$

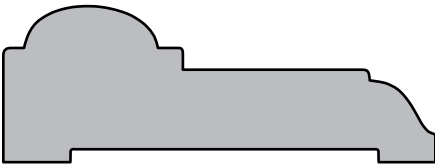

SWD 056 | $1\frac{3}{16}'' \times 2\frac{1}{4}''$

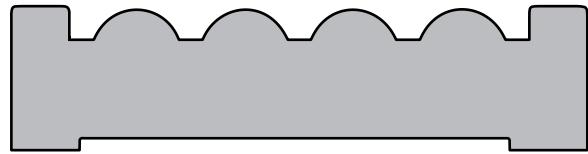

SWD 057 | $\frac{3}{4}'' \times 3''$



SWD 058 | $\frac{3}{4}'' \times 2\frac{1}{2}''$

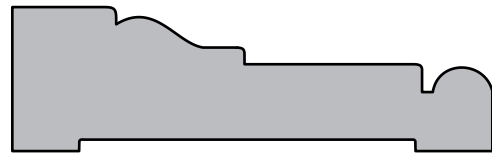

SWD 059 | $\frac{3}{4}'' \times 2\frac{1}{2}''$

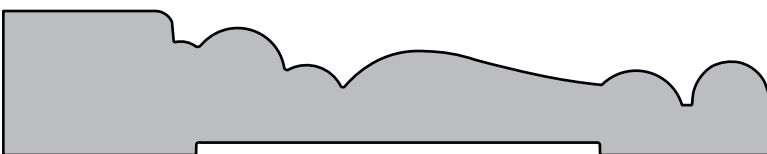

SWD 060 | $\frac{3}{4}'' \times 4''$

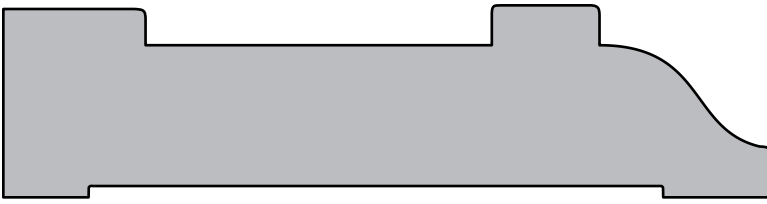

SWD 061 | 1" x 4"



SWD 062 | 3/4" x 3 1/4"

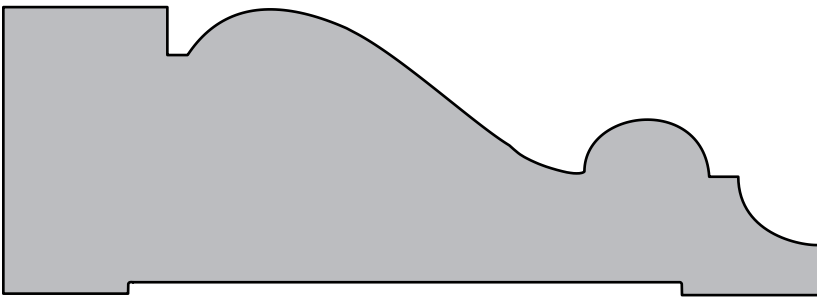

SWD 063 | 1 1/2" x 4 1/4"

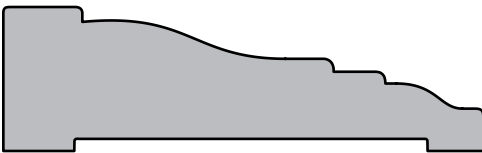

SWD 064 | 3/4" x 2 1/2"

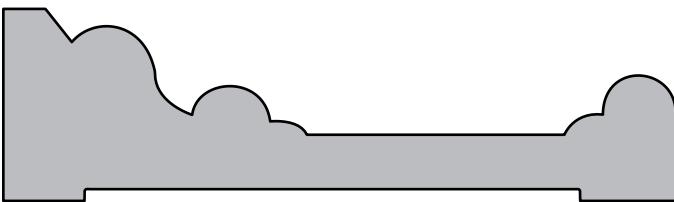

SWD 065 | 1" x 3 1/2"

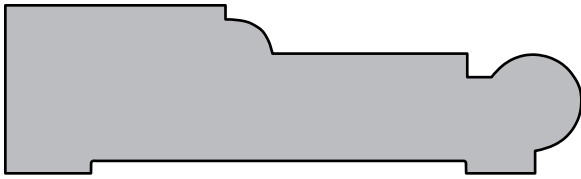

SWD 066 | $\frac{7}{8}$ " x 3"

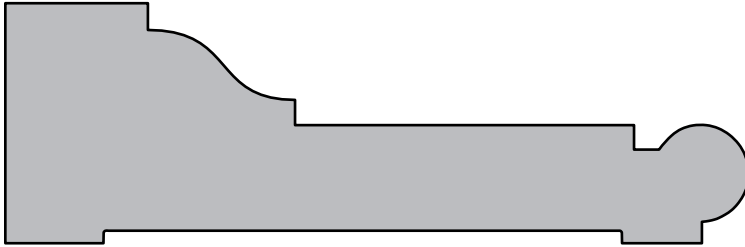

SWD 067 | $1\frac{1}{4}$ " x $3\frac{7}{8}$ "

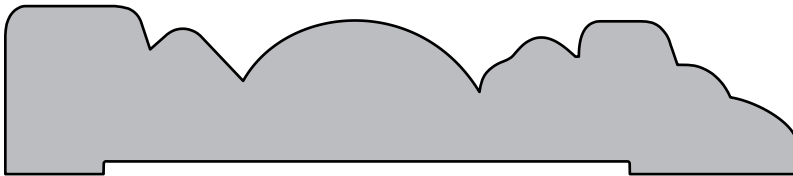

SWD 068 | $\frac{7}{8}$ " x $4\frac{1}{8}$ "

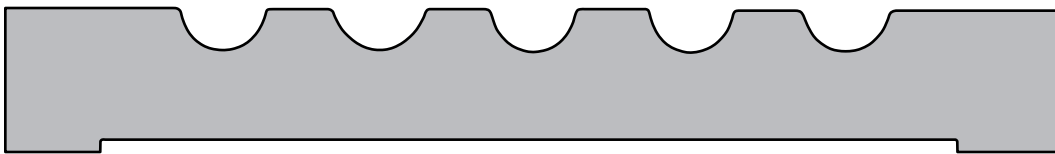

SWD 069 | $\frac{3}{4}$ " x $5\frac{1}{2}$ "

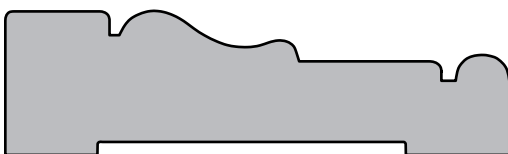

SWD 070 | $\frac{3}{4}$ " x $2\frac{5}{8}$ "



SWD 071 | $\frac{3}{4}$ " x Customer Specs

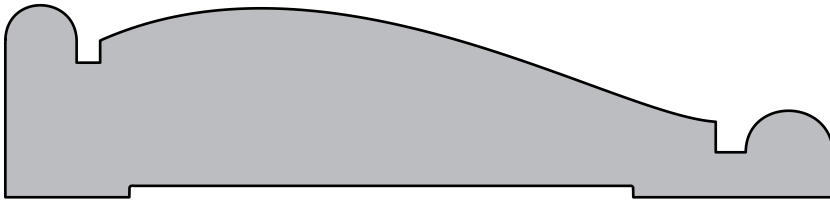

SWD 072 | $1\frac{4}{16}$ "



SWD 073 | $\frac{3}{4}$ " x $3\frac{1}{4}$ "

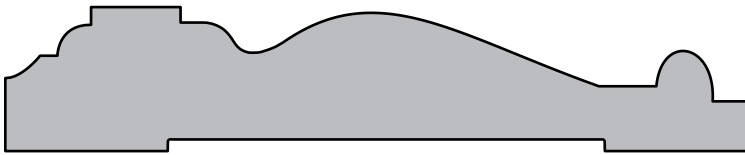

SWD 074 | $\frac{3}{4}$ " x $3\frac{7}{8}$ "



SWD 075 | $1\frac{1}{8}$ " x 5"

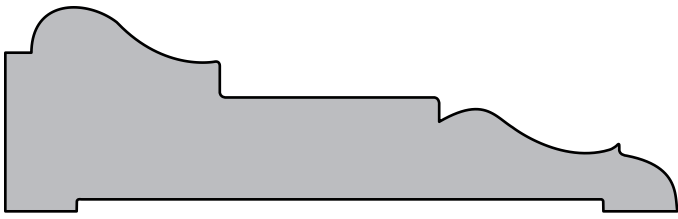

SWD 076 | $1\frac{1}{16}'' \times 3\frac{1}{2}''$



SWD 077 | $1\frac{1}{16}'' \times 4\frac{1}{2}''$

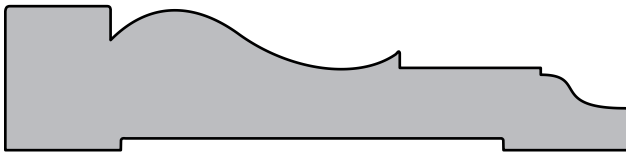

SWD 078 | $\frac{3}{4}'' \times 3\frac{1}{4}''$

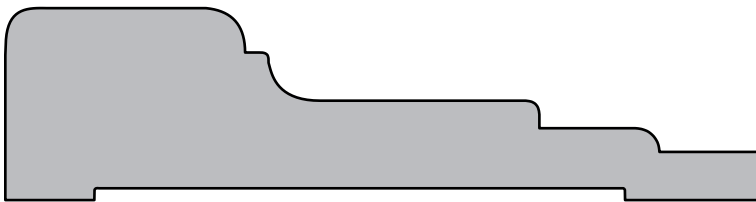

SWD 079 | $1'' \times 3\frac{15}{16}''$

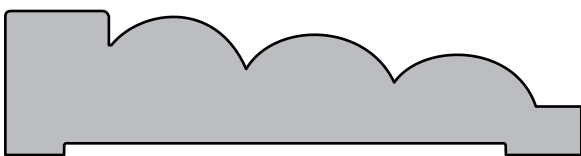

SWD 080 | $\frac{3}{4}'' \times 3''$

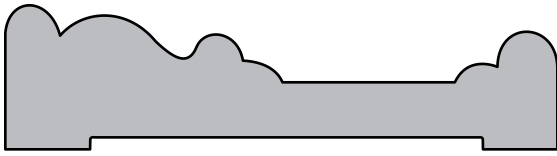

SWD 081 | $\frac{3}{4}'' \times 2\frac{7}{8}''$

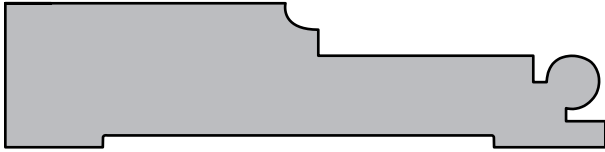

SWD 082 | $\frac{3}{4}'' \times 3\frac{1}{8}''$

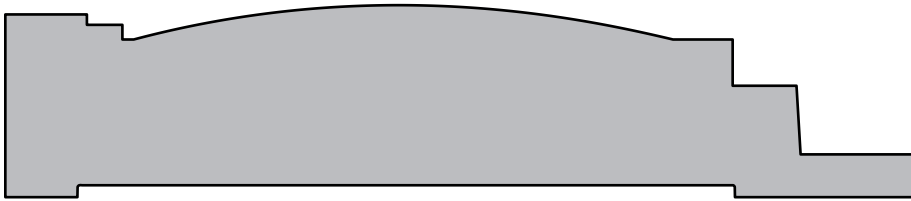

SWD 083 | $1'' \times 4\frac{3}{4}''$



SWD 084 | $\frac{3}{4}'' \times 3\frac{1}{2}''$



SWD 085 | $\frac{3}{4}'' \times 3\frac{1}{2}''$

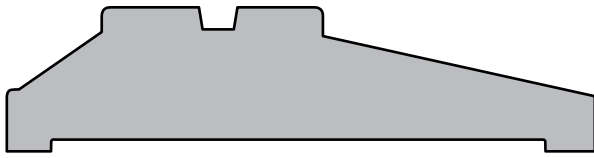

SWD 086 | $\frac{3}{4}'' \times 3\frac{1}{16}''$

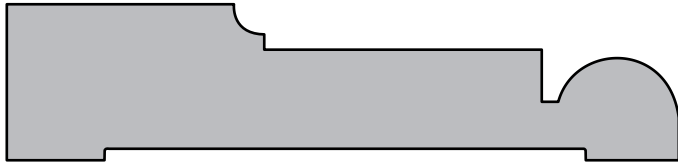

SWD 087 | $1\frac{3}{16}'' \times 3\frac{1}{2}''$

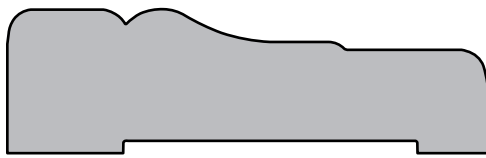

SWD 088 | $\frac{3}{4}'' \times 2\frac{1}{2}''$

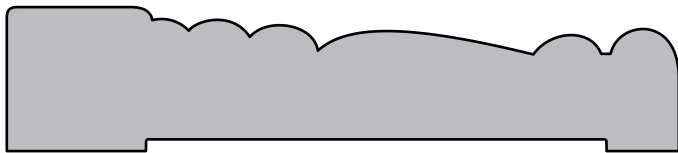

SWD 089 | $\frac{3}{4}'' \times 3\frac{1}{2}''$

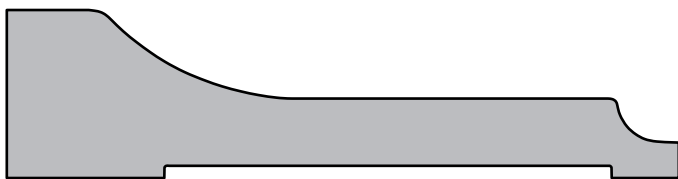

SWD 090 | $\frac{7}{8}'' \times 3\frac{1}{2}''$

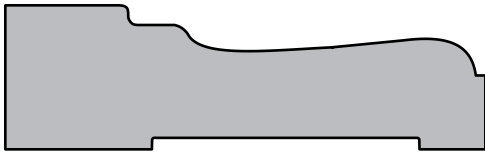

SWD 091 | $\frac{3}{4}'' \times 2\frac{1}{2}''$

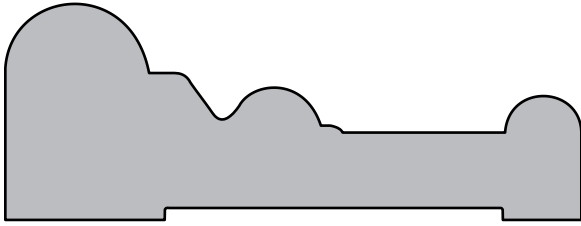

SWD 092 | $1\frac{1}{8}'' \times 3''$

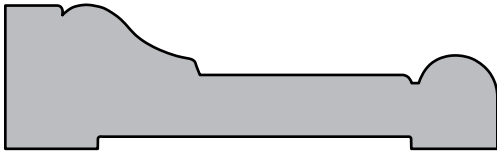

SWD 093 | $\frac{3}{4}'' \times 2\frac{9}{16}''$



SWD 094 | $\frac{3}{4}'' \times 4''$

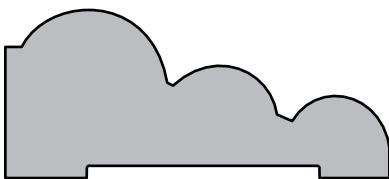

SWD 095 | $\frac{7}{8}'' \times 2''$

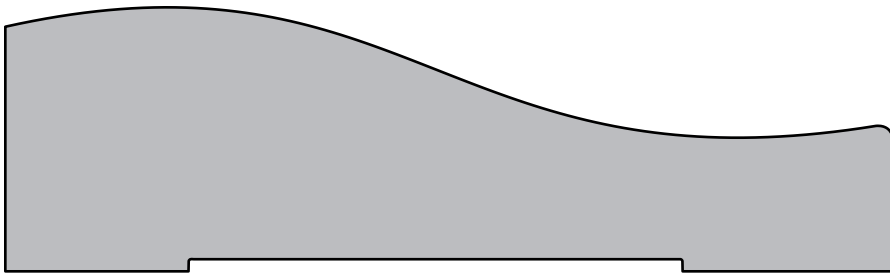

SWD 096 | $1\frac{3}{8}'' \times 4\frac{5}{8}''$

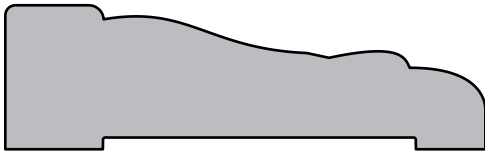

SWD 097 | $\frac{3}{4}'' \times 2\frac{1}{2}''$



SWD 098 | $1\frac{1}{16}'' \times 2\frac{1}{2}''$

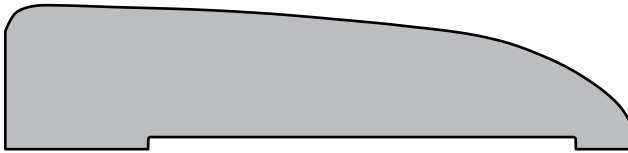

SWD 099 | $\frac{3}{4}'' \times 3\frac{1}{4}''$

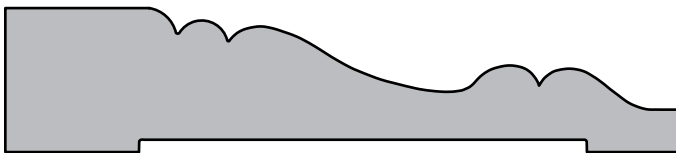

SWD 100 | $\frac{3}{4}'' \times 3\frac{1}{2}''$



SWD 101 | $\frac{3}{4}'' \times 2\frac{3}{8}''$



SWD 102 | $\frac{3}{4}$ " x Customer Specs

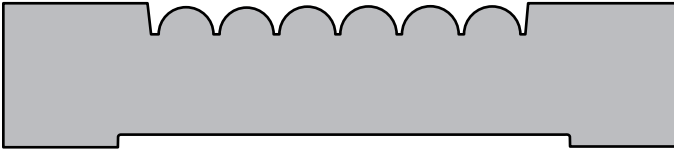

SWD 103 | $\frac{3}{4}$ " x $3\frac{1}{2}$ "

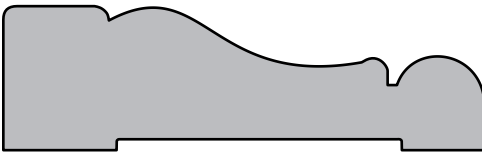

SWD 104 | $\frac{3}{4}$ " x $2\frac{1}{2}$ "

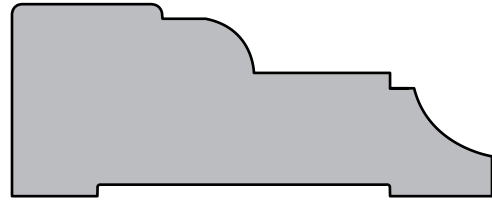

SWD 105 | 1" x $2\frac{1}{2}$ "

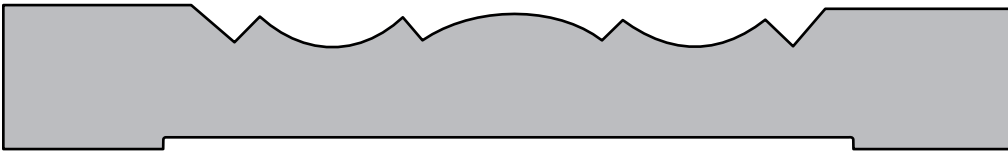

SWD 106 | $\frac{3}{4}$ " x $5\frac{1}{4}$ "

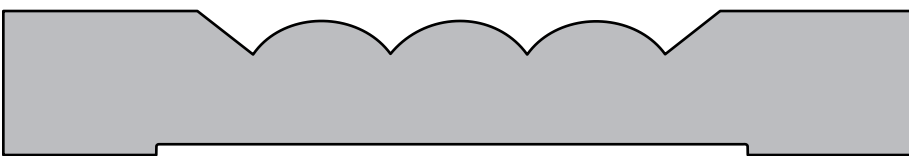

SWD 107 | $\frac{3}{4}$ " x $4\frac{3}{4}$ "



SWD 108 | $\frac{3}{4}$ " x Customer Specs



SWD 109 | $\frac{3}{4}$ " x Customer Specs

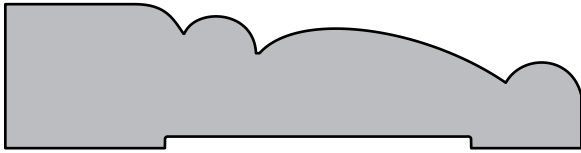

SWD 110 | $\frac{3}{4}$ " x 3"

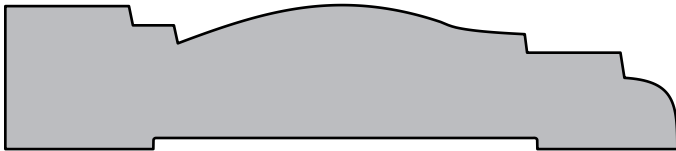

SWD 111 | $\frac{3}{4}$ " x 3 $\frac{1}{2}$ "

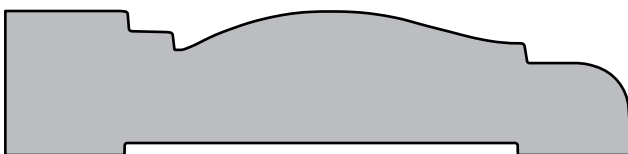

SWD 112 | $\frac{3}{4}$ " x 3 $\frac{1}{4}$ "



SWD 113 | $\frac{3}{4}$ " x Customer Specs



SWD 114 | $\frac{3}{4}$ " x Customer Specs

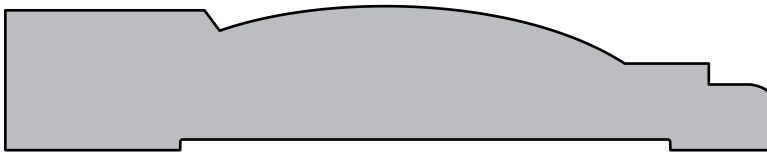

SWD 115 | $\frac{3}{4}$ " x 4"

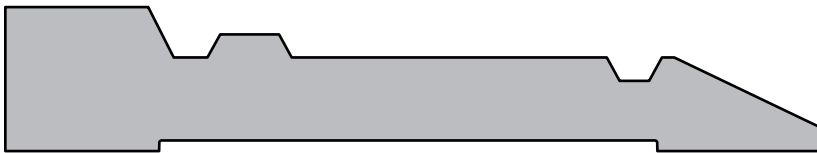

SWD 116 | $\frac{3}{4}$ " x 4 $\frac{1}{4}$ "

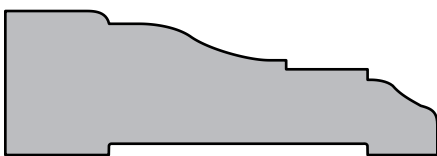

SWD 117 | $\frac{3}{4}$ " x 2 $\frac{1}{4}$ "

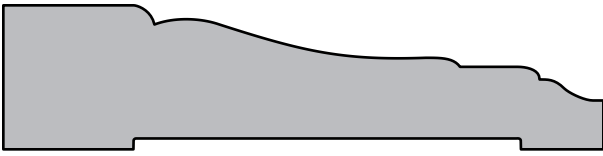

SWD 118 | $\frac{3}{4}'' \times 3\frac{1}{8}''$

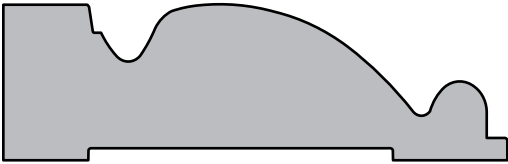

SWD 119 | $1\frac{3}{16}'' \times 2\frac{5}{8}''$

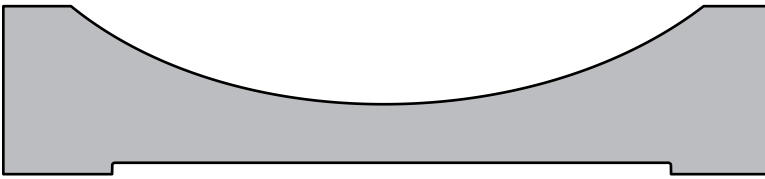

SWD 120 | $\frac{7}{8}'' \times 4''$

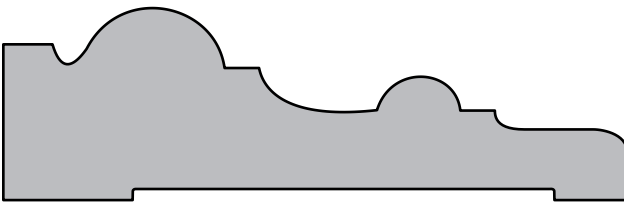

SWD 121 | $1'' \times 3\frac{1}{4}''$

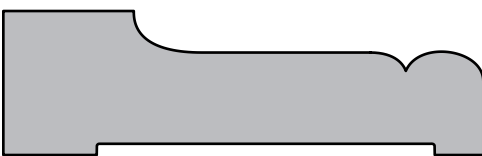

SWD 122 | $\frac{3}{4}'' \times 2\frac{1}{2}''$

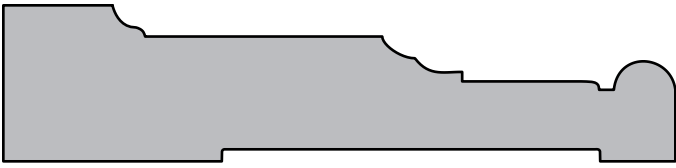

SWD 123 | $1\frac{3}{16}'' \times 3\frac{1}{2}''$

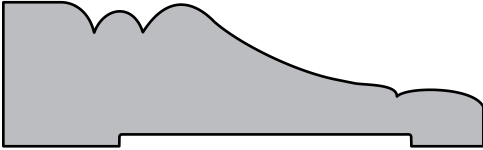

SWD 124 | $\frac{3}{4}'' \times 2\frac{1}{2}''$



SWD 125 | $\frac{3}{4}'' \times 3\frac{1}{2}''$

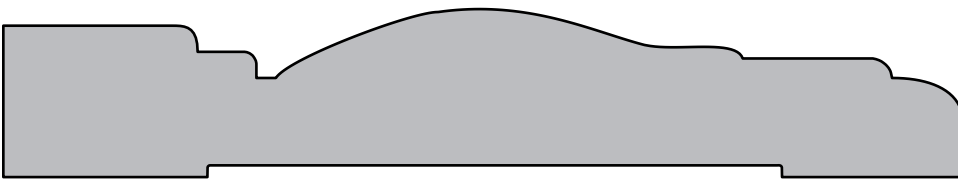

SWD 126 | $\frac{7}{8}'' \times 5''$

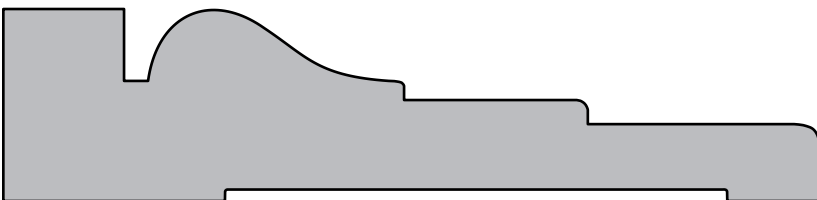

SWD 127 | $1'' \times 4\frac{1}{4}''$

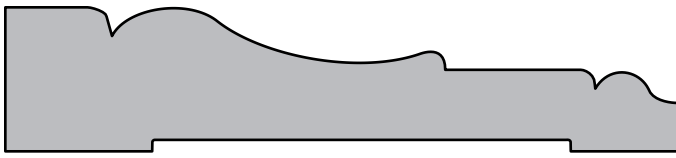

SWD 128 | $\frac{3}{4}'' \times 3\frac{1}{2}''$



SWD 129 | $\frac{3}{4}'' \times$ Customer Specs

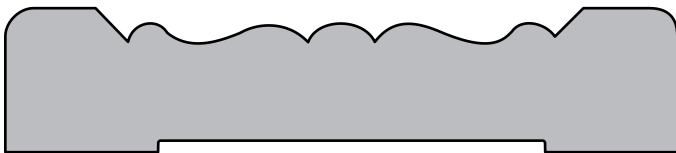

SWD 130 | $\frac{3}{4}'' \times 3\frac{1}{2}''$

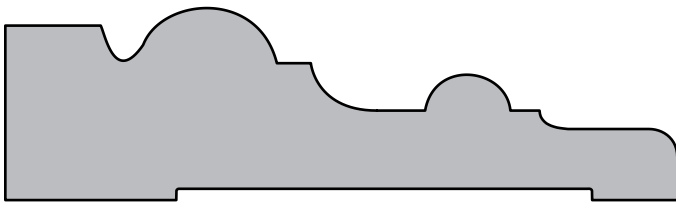

SWD 131 | $1'' \times 3\frac{1}{2}''$

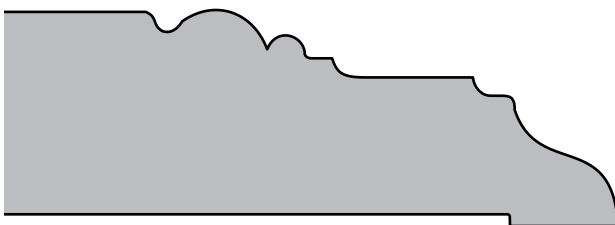

SWD 132 | $1\frac{1}{8}'' \times$ Customer Specs



SWD 133 | $\frac{3}{4}'' \times$ Customer Specs



SWD 134 | $\frac{3}{4}$ " x Customer Specs

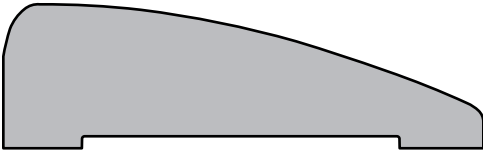

SWD 135 | $\frac{3}{4}$ " x $2\frac{1}{2}$ "

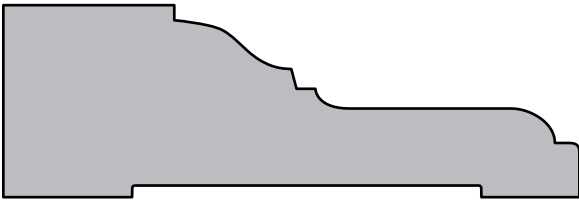

SWD 136 | 1" x 3"



SWD 137 | $\frac{3}{4}$ " x $3\frac{1}{2}$ "

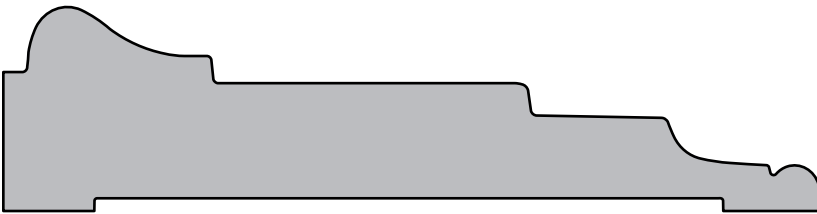

SWD 138 | $1\frac{1}{16}$ " x $4\frac{1}{4}$ "



SWD 139 | 1" x Customer Specs

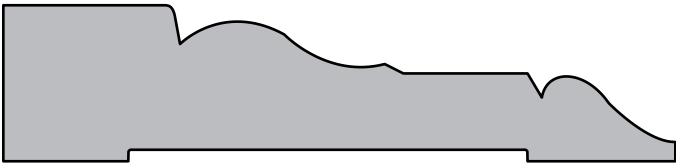

SWD 140 | $1\frac{3}{16}$ " x $3\frac{1}{2}$ "

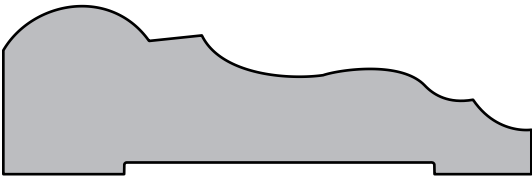

SWD 141 | $\frac{7}{8}$ " x $2\frac{3}{4}$ "



SWD 142 | $\frac{1}{2}$ " x Customer Specs



SWD 143 | $\frac{3}{8}$ " x Customer Specs

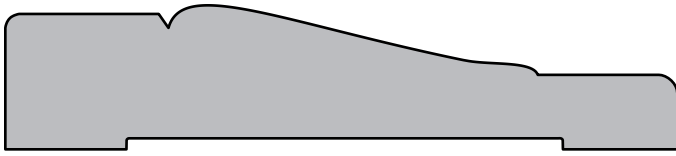

SWD 144 | $\frac{3}{4}$ " x $3\frac{1}{2}$ "



SWD 145 | $\frac{3}{4}$ " x Customer Specs

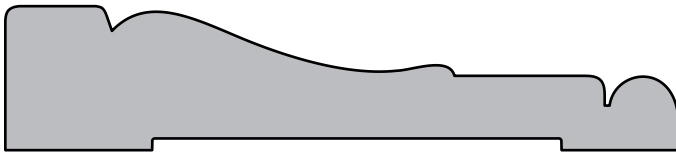

SWD 146 | $\frac{3}{4}$ " x $3\frac{1}{2}$ "

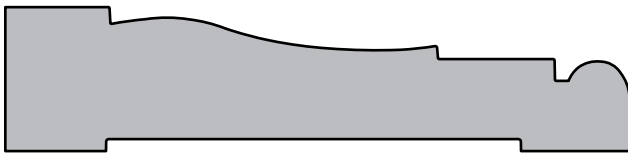

SWD 147 | $\frac{3}{4}$ " x $3\frac{1}{4}$ "

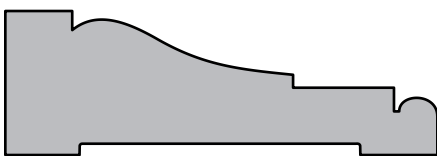

SWD 148 | $\frac{3}{4}$ " x $2\frac{1}{4}$ "

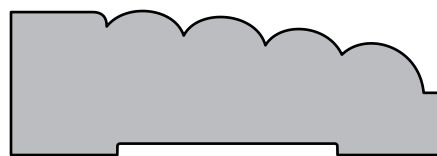

SWD 149 | $\frac{3}{4}$ " x $2\frac{1}{4}$ "

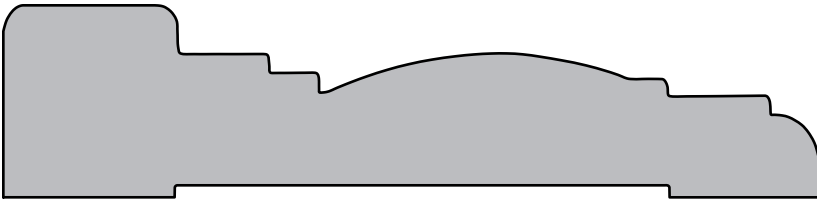

SWD 150 | 1" x 4 $\frac{1}{4}$ "



SWD 151 | $\frac{3}{4}$ " x 2 $\frac{1}{4}$ "



SWD 152 | $\frac{3}{4}$ " x Customer Specs

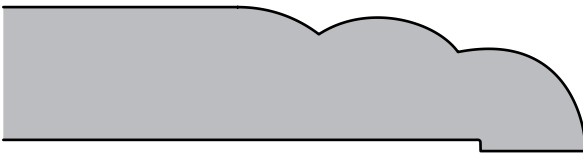

SWD 153 | $\frac{3}{4}$ " x Customer Specs

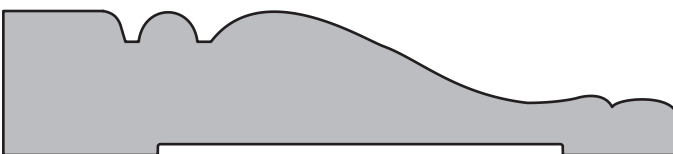

SWD 154 | $\frac{3}{4}$ " x 3 $\frac{1}{2}$ "

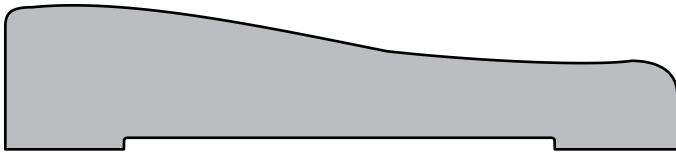

SWD 155 | $\frac{3}{4}$ " x $2\frac{1}{2}$ "



SWD 156 | $\frac{3}{4}$ " x Customer Specs



SWD 156-B | $\frac{3}{4}$ " x $\frac{7}{16}$ "



SWD 157 | $\frac{3}{4}$ " x Customer Specs

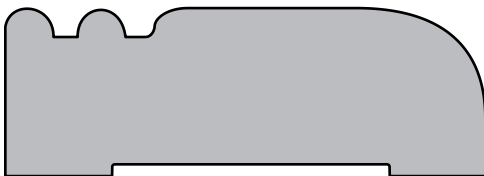

SWD 158 | $\frac{7}{8}$ " x $2\frac{1}{2}$ "

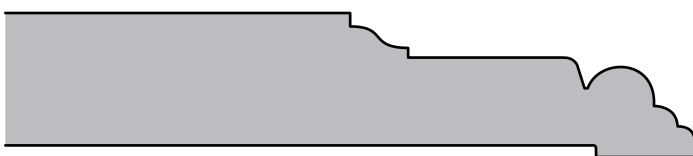

SWD 159 | $\frac{3}{4}$ " x Customer Specs



SWD 160 | $\frac{3}{4}$ " x Customer Specs



SWD 161 | $\frac{3}{4}$ " x $4\frac{1}{4}$ "

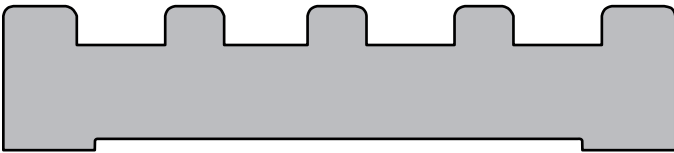

SWD 162 | $\frac{3}{4}$ " x $3\frac{1}{2}$ "



SWD 163 | $\frac{3}{4}$ " x Customer Specs

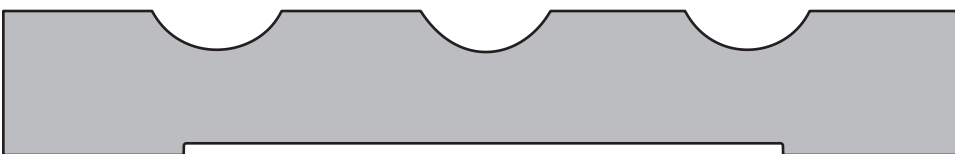

SWD 164 | $\frac{3}{4}$ " x 5"

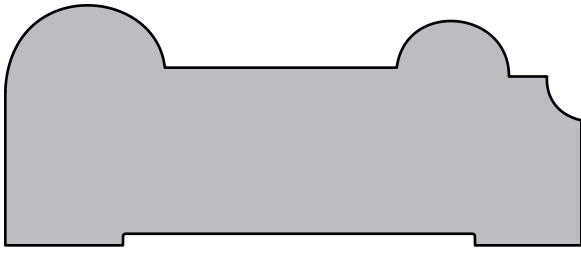

SWD 165 | $1\frac{1}{4}'' \times 3''$

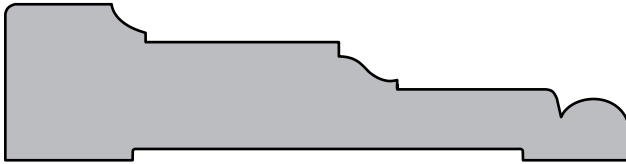

SWD 166 | $1\frac{3}{16}'' \times 3\frac{1}{4}''$

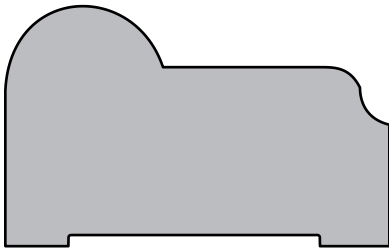

SWD 167 | $1\frac{1}{4}'' \times 2''$

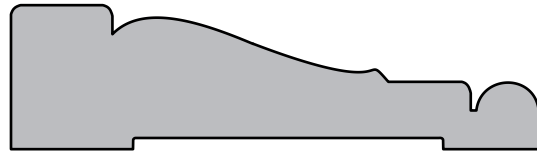

SWD 168 | $\frac{3}{4}'' \times 2\frac{3}{4}''$

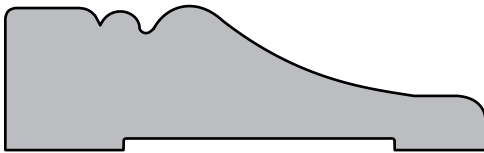

SWD 169 | $\frac{3}{4}'' \times 2\frac{1}{2}''$



SWD 170 | $\frac{3}{4}'' \times 2\frac{1}{4}''$

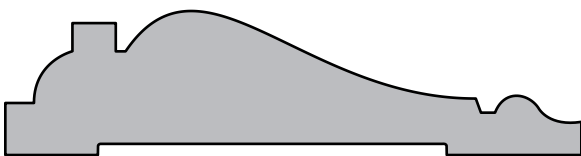

SWD 171 | $\frac{3}{4}'' \times 3''$

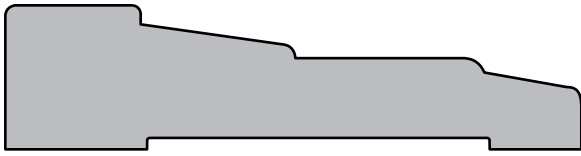

SWD 172 | $\frac{3}{4}$ " x 3"



SWD 173 | $\frac{3}{4}$ " x Customer Specs

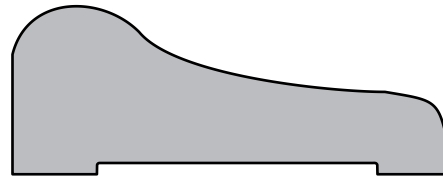

SWD 174 | $\frac{7}{8}$ " x 2 $\frac{1}{4}$ "



SWD 175 | $\frac{3}{4}$ " x Customer Specs

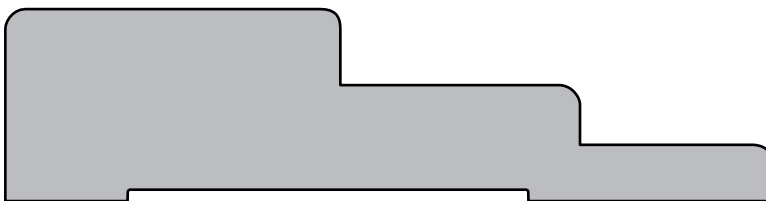

SWD 176 | 1" x 4"



SWD 177 | $\frac{3}{4}$ " x Customer Specs

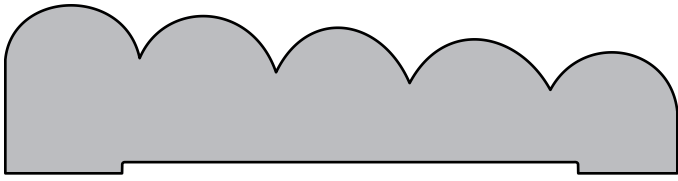

SWD 178 | $\frac{7}{8}'' \times 3\frac{1}{2}''$

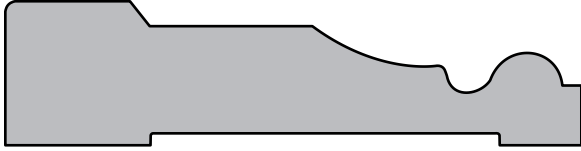

SWD 179 | $\frac{3}{4}'' \times 3''$



SWD 180 | $\frac{3}{4}'' \times$ Customer Specs

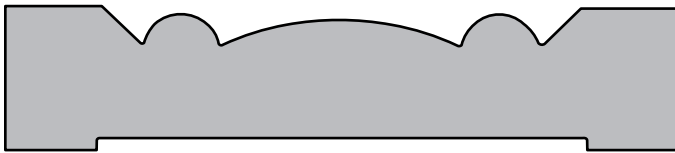

SWD 181 | $\frac{3}{4}'' \times 3\frac{1}{2}''$

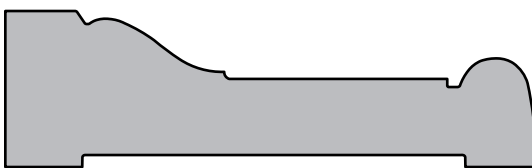

SWD 182 | $1\frac{3}{16}'' \times 2\frac{3}{4}''$

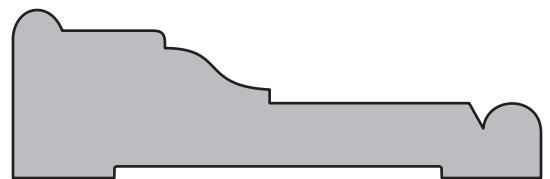

SWD 183 | $\frac{7}{8}'' \times 2\frac{3}{4}''$



SWD 184 | $\frac{3}{4}'' \times 2\frac{1}{2}''$

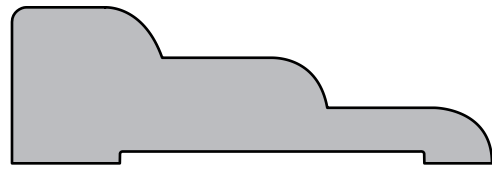

SWD 185 | $1\frac{3}{16}'' \times 2\frac{1}{2}''$



SWD 186 | $\frac{3}{4}'' \times 4''$



SWD 187 | $\frac{3}{4}'' \times 4''$

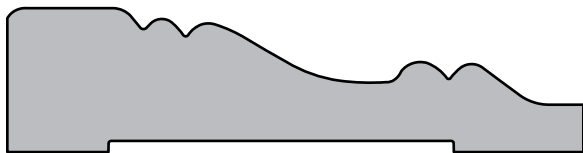

SWD 188 | $\frac{3}{4}'' \times 3''$

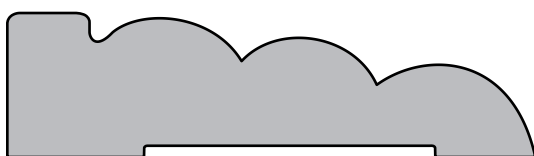

SWD 189 | $\frac{3}{4}'' \times 2\frac{3}{4}''$



SWD 190 | $\frac{3}{4}'' \times 2\frac{3}{4}''$

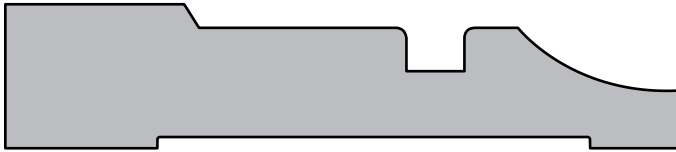

SWD 191 | $\frac{3}{4}'' \times 3\frac{1}{2}''$

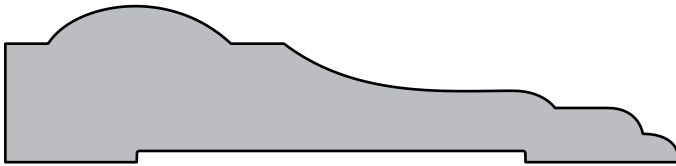

SWD 192 | $1\frac{3}{16}'' \times 3\frac{1}{2}''$

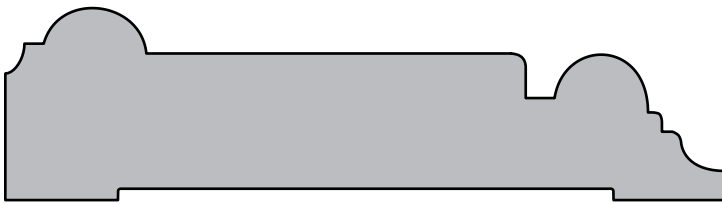

SWD 193 | $1'' \times 3\frac{3}{4}''$



SWD 194 | $\frac{3}{4}'' \times 3\frac{1}{2}''$

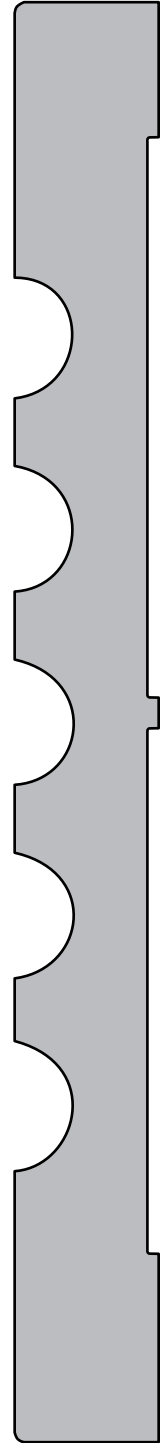

SWD 196 | $\frac{3}{4}'' \times 7\frac{1}{2}''$

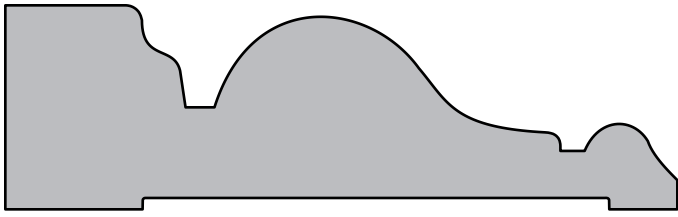

SWD 195 | $1\frac{1}{16}'' \times 3\frac{1}{2}''$

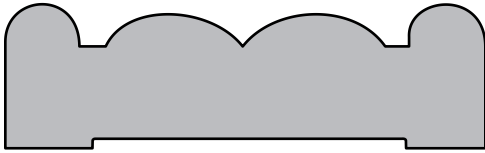

SWD 197 | $\frac{3}{4}'' \times 2\frac{1}{2}''$

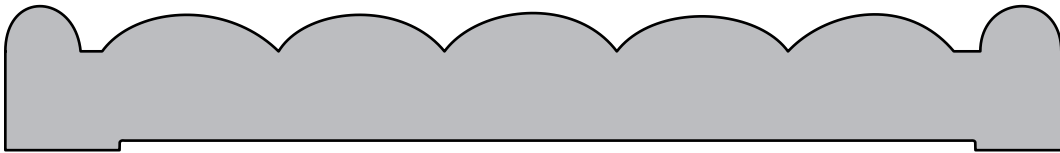

SWD 198 | $\frac{3}{4}'' \times 5\frac{1}{2}''$

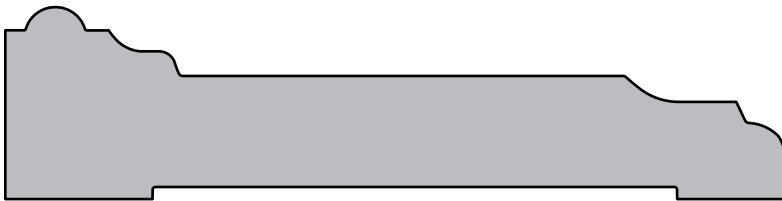

SWD 199 | $1'' \times 4\frac{1}{16}''$

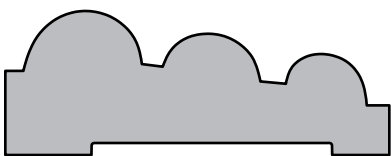

SWD 1000 | $\frac{3}{4}'' \times 2''$

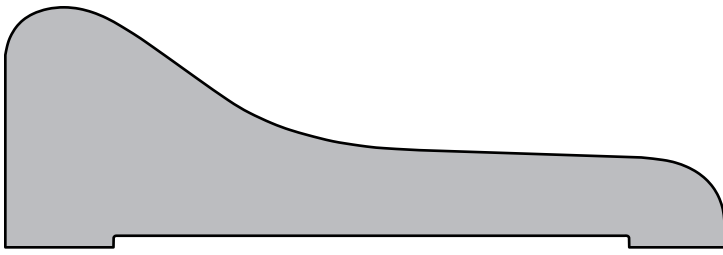

SWD 1001 | $1\frac{1}{4}'' \times 3\frac{3}{4}''$



SWD 1002 | $\frac{3}{4}'' \times$ Customer Specs



SWD 1003 | $\frac{3}{4}'' \times 4\frac{1}{4}''$

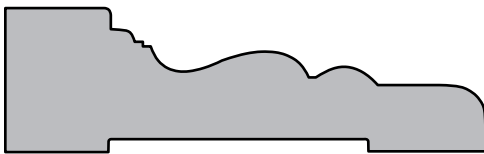

SWD 1004 | $\frac{3}{4}'' \times 2\frac{1}{2}''$

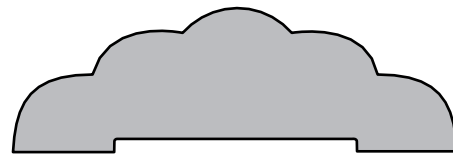

SWD 1005 | $\frac{3}{4}'' \times 2\frac{5}{16}''$

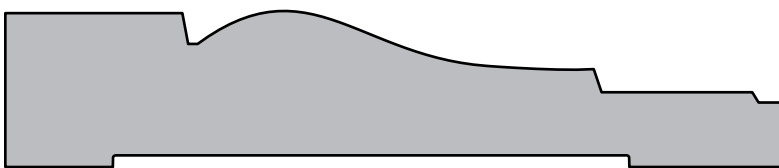

SWD 1006 | $1\frac{3}{16}'' \times 4\frac{1}{16}''$

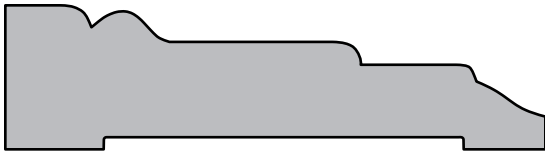

SWD 1007 | $\frac{3}{4}'' \times 2\frac{13}{16}''$



SWD 1008 | $\frac{3}{4}'' \times 3\frac{1}{2}''$

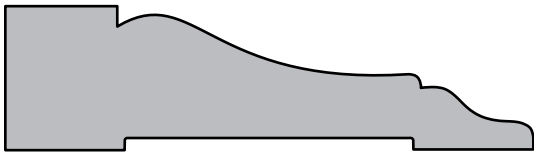

SWD 1009 | $\frac{3}{4}'' \times 2\frac{3}{4}''$



SWD 1010 | $\frac{3}{4}'' \times 3\frac{1}{2}''$

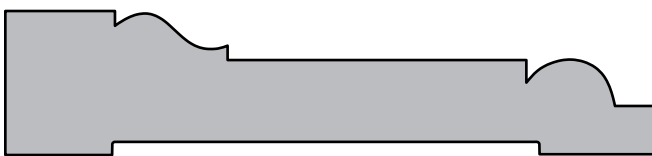

SWD 1011 | $\frac{3}{4}'' \times 3\frac{3}{8}''$

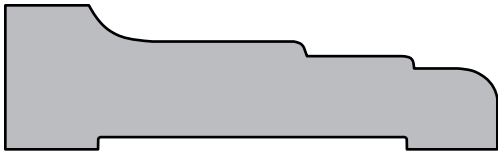

SWD 1012 | $\frac{3}{4}'' \times 2\frac{9}{16}''$

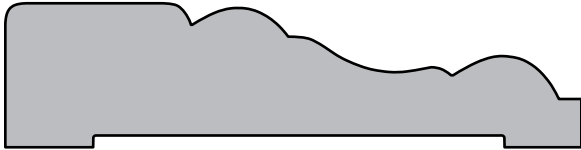

SWD 1013 | $\frac{3}{4}'' \times 3''$

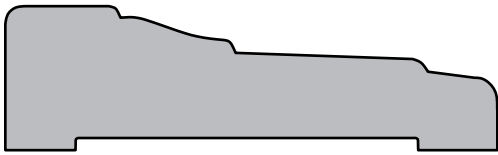

SWD 1014 | $\frac{3}{4}'' \times 2\frac{9}{16}''$

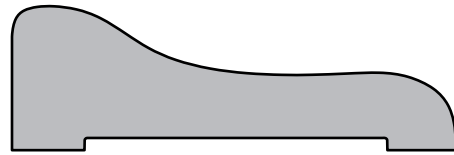

SWD 1015 | $\frac{3}{4}'' \times 2\frac{5}{16}''$

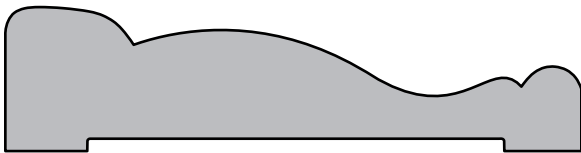

SWD 1016 | $\frac{3}{4}'' \times 3''$

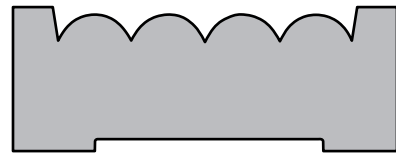

SWD 1017 | $\frac{3}{4}'' \times 2''$

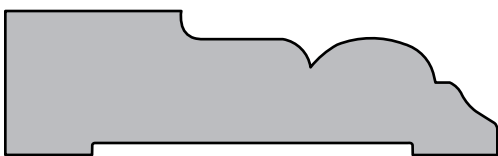

SWD 1018 | $\frac{3}{4}'' \times 2\frac{9}{16}''$

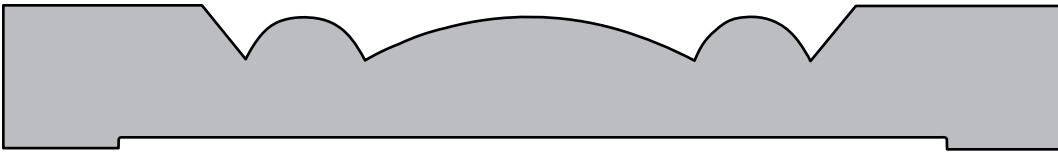

SWD 1019 | $\frac{3}{4}'' \times 5\frac{1}{2}''$

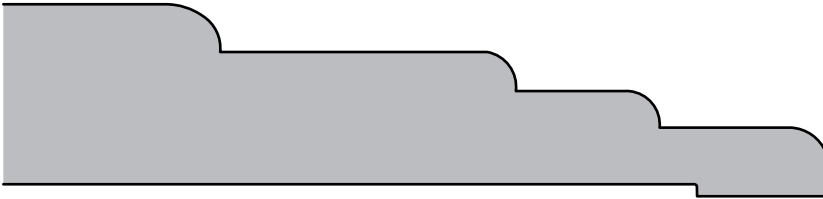

SWD 1020 | 1" x Customer Specs

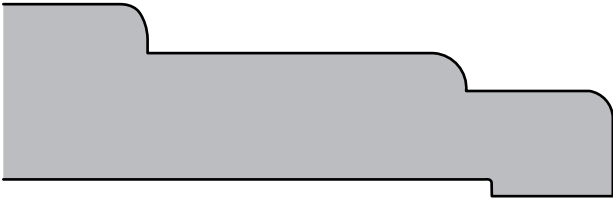

SWD 1021 | 1" x Customer Specs

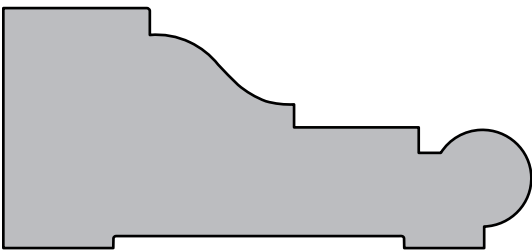

SWD 1022 | $1\frac{1}{4}'' \times 2\frac{3}{4}''$

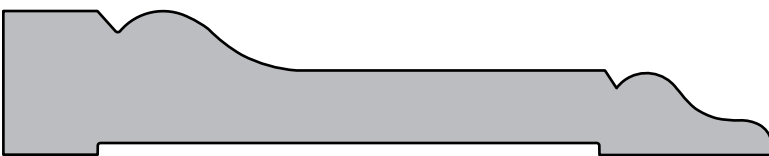

SWD 1023 | $\frac{3}{4}'' \times 4''$

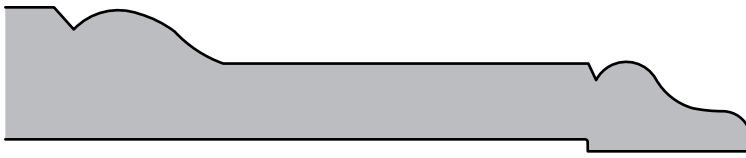

SWD 1024 | $\frac{3}{4}$ " x Customer Specs

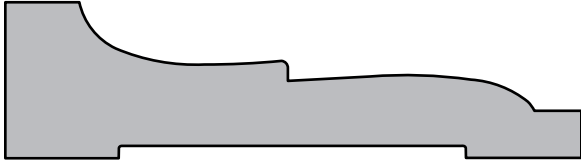

SWD 1025 | $1\frac{3}{16}$ " x 3"

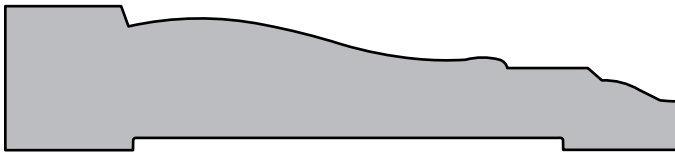

SWD 1026 | $\frac{3}{4}$ " x $3\frac{1}{2}$ "

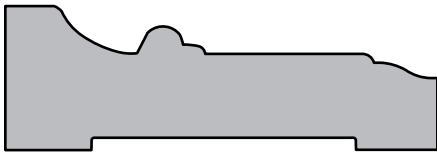

SWD 1027 | $\frac{3}{4}$ " x $2\frac{1}{4}$ "



SWD 1028 | $\frac{3}{4}$ " x $3\frac{3}{8}$ "

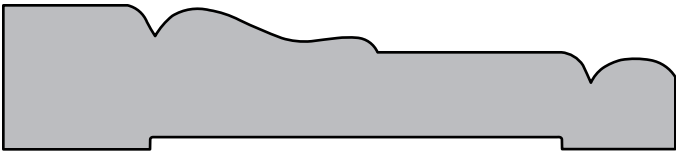

SWD 1029 | $\frac{3}{4}'' \times 3\frac{1}{2}''$

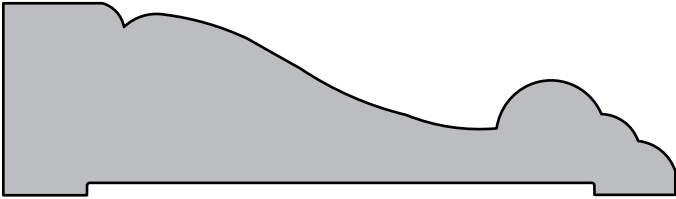

SWD 1030 | $1'' \times 3\frac{1}{2}''$

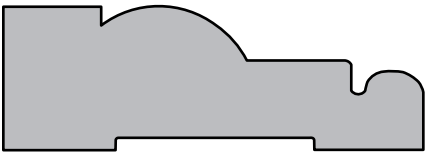

SWD 1031 | $\frac{3}{4}'' \times 2\frac{3}{16}''$

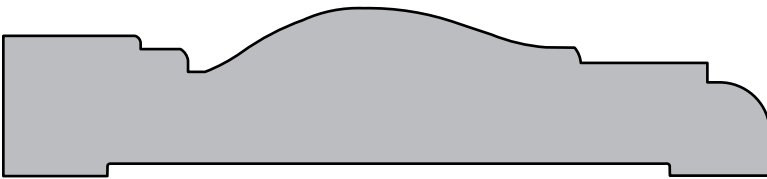

SWD 1032 | $\frac{7}{8}'' \times 4''$



SWD 1033 | $\frac{3}{4}'' \times 3\frac{1}{8}''$



SWD 1034 | 1" x 3"

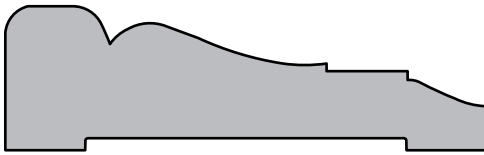

SWD 1035 | 3/4" x 2 1/2"



SWD 1036 | 1 3/16" x 3 1/2"



SWD 1037 | 3/4" x 3 1/4"

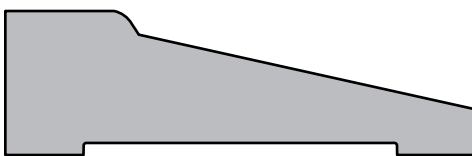

SWD 1038 | 3/4" x 2 7/16"

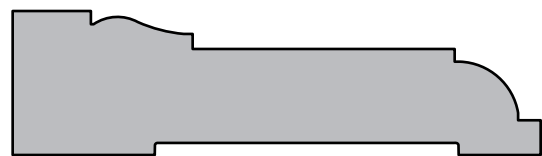

SWD 1039 | 3/4" x 2 3/4"

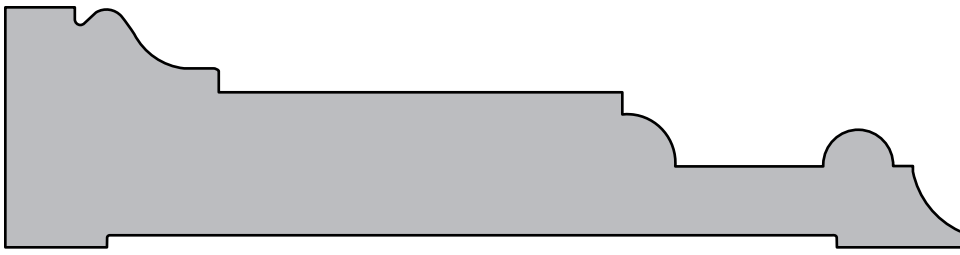

SWD 1040 | $1\frac{1}{4}'' \times 5''$

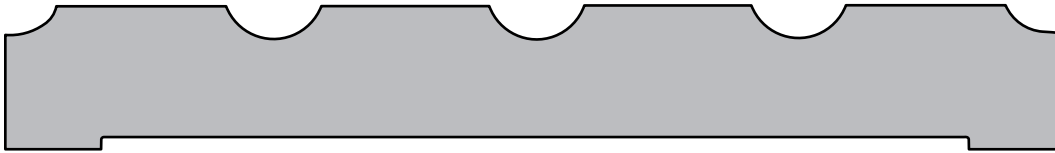

SWD 1041 | $\frac{3}{4}'' \times 5\frac{1}{2}''$

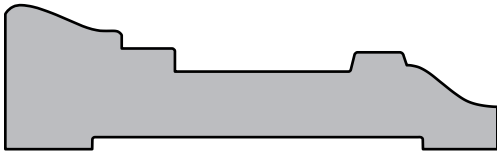

SWD 1042 | $\frac{3}{4}'' \times 2\frac{9}{16}''$

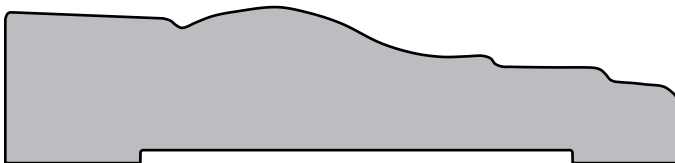

SWD 1043 | $1\frac{3}{16}'' \times 3\frac{1}{2}''$



SWD 1044 | $1'' \times 4''$



SWD 1045 | $\frac{3}{4}'' \times 3\frac{1}{2}''$

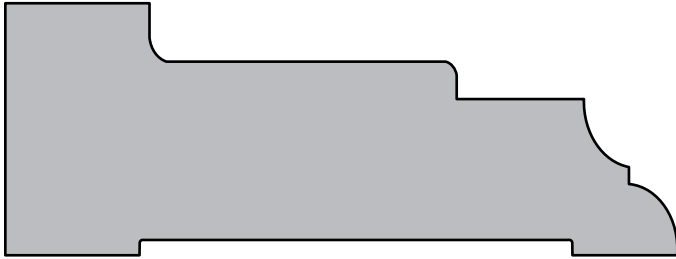

SWD 1046 | $1\frac{5}{16}'' \times 3\frac{1}{2}''$



SWD 1047 | $1\frac{3}{16}'' \times 4''$

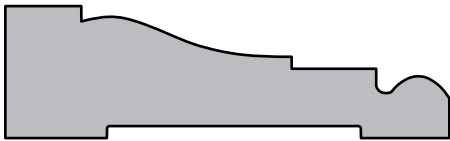

SWD 1048 | $1\frac{1}{16}'' \times 2\frac{5}{16}''$

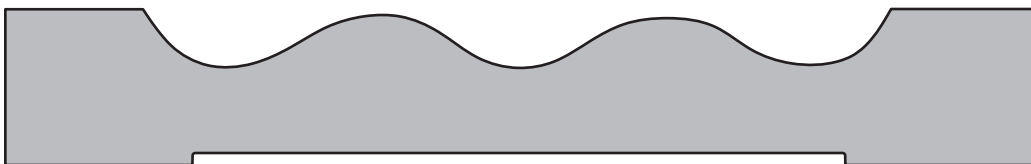

SWD 1049 | $1\frac{3}{16}'' \times 5\frac{1}{2}''$

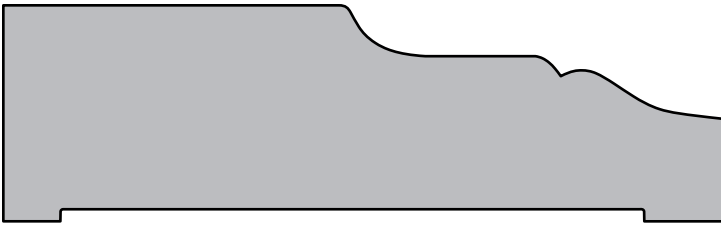

SWD 1050 | $1\frac{1}{8}'' \times 3\frac{3}{4}''$



SWD 1051 | $\frac{3}{4}'' \times 3\frac{1}{2}''$



SWD 1052 | $\frac{5}{8}'' \times 3''$

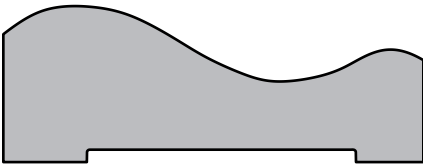

SWD 1053 | $1\frac{3}{16}'' \times 2\frac{3}{16}''$



SWD 1054 | $\frac{3}{4}'' \times 3\frac{1}{2}''$

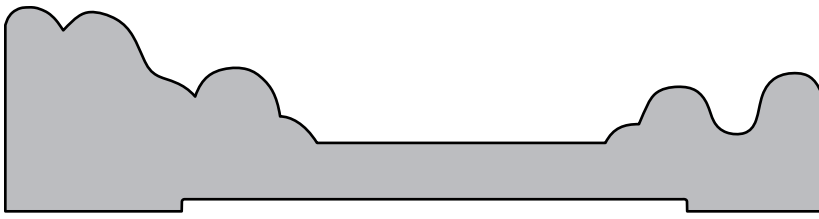

SWD 1055 | $1\frac{1}{16}'' \times 4\frac{1}{4}''$

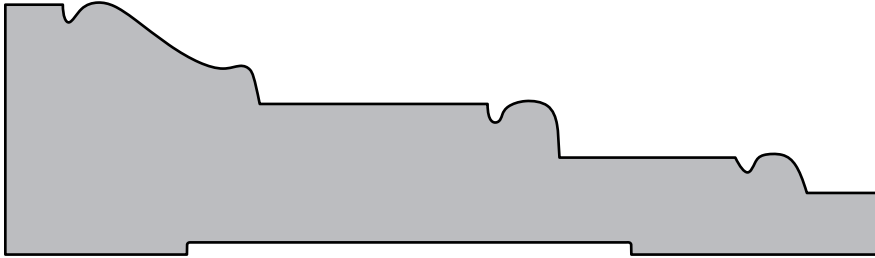

SWD 1056 | $1\frac{5}{16}'' \times 4\frac{9}{16}''$

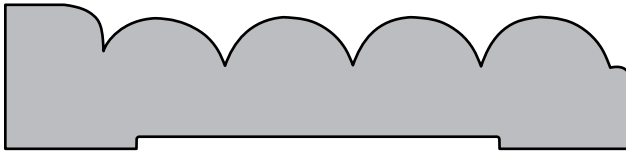

SWD 1057 | $\frac{3}{4}'' \times 3\frac{1}{4}''$

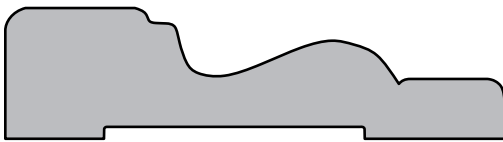

SWD 1058 | $1\frac{1}{16}'' \times 2\frac{5}{8}''$

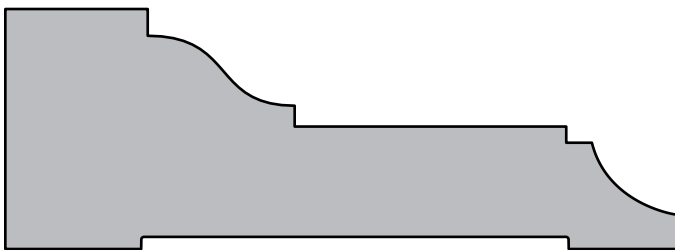

SWD 1059 | $1\frac{1}{4}'' \times 3\frac{1}{2}''$

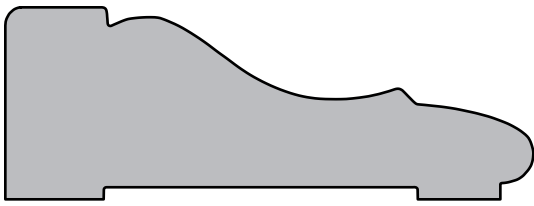

SWD 1060 | 1" x 2³/₄"

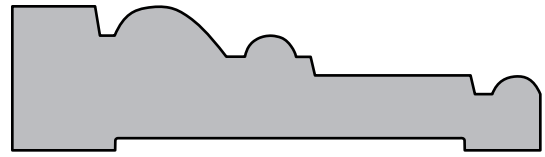

SWD 1061 | 3/4" x 2³/₄"

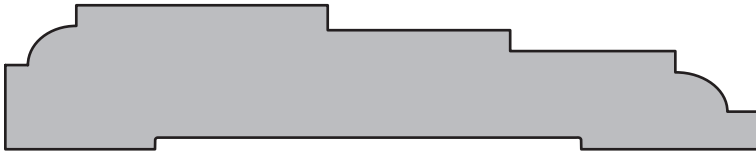

SWD 1062 | 3/4" x 3¹⁵/₁₆"

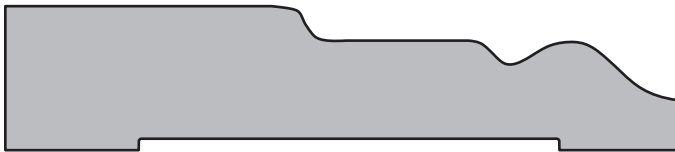

SWD 1063 | 3/4" x 3¹/₂"

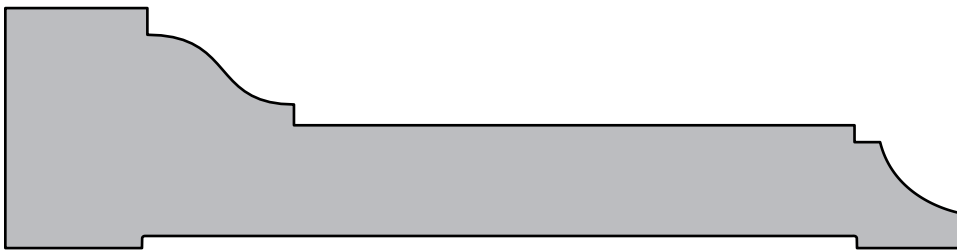

SWD 1064 | 1¹/₄" x 5"

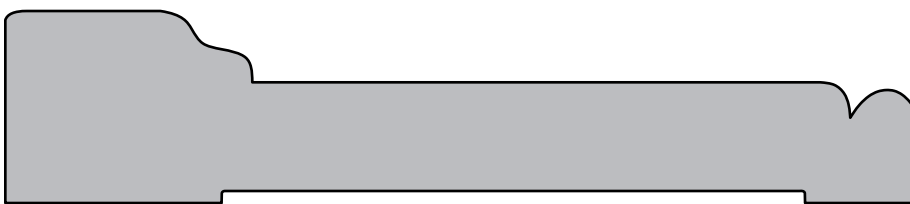

SWD 1065 | 1" x 4³/₄"

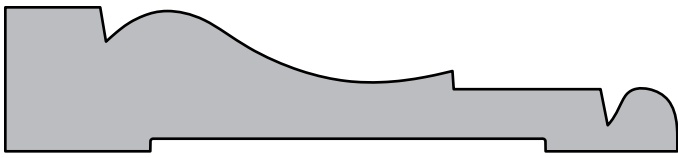

SWD 1066 | $\frac{3}{4}'' \times 3\frac{1}{2}''$

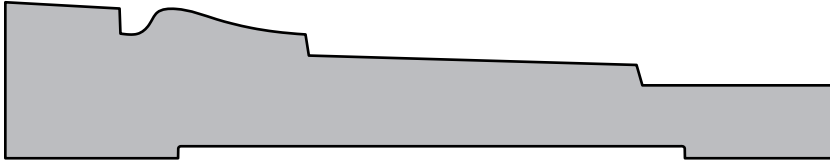

SWD 1067 | $\frac{13}{16}'' \times 4\frac{5}{16}''$



SWD 1068 | $\frac{3}{4}'' \times 2\frac{1}{2}''$



SWD 1069 | $\frac{3}{4}'' \times 3''$



SWD 1070 | $\frac{7}{8}'' \times 4\frac{3}{16}''$

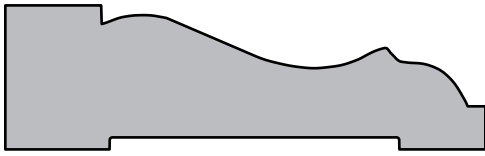

SWD 1071 | $\frac{3}{4}'' \times 2\frac{1}{2}''$

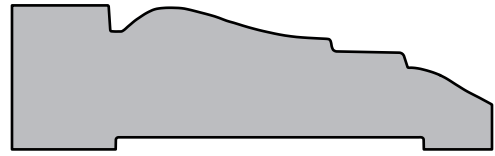

SWD 1072 | $\frac{3}{4}'' \times 2\frac{1}{2}''$



SWD 1073 | $\frac{3}{4}'' \times 2\frac{1}{4}''$

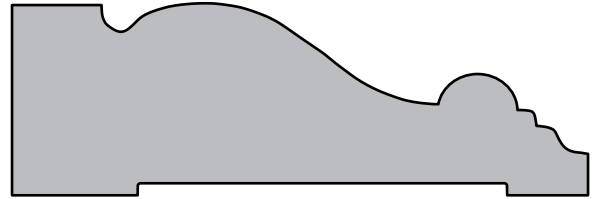

SWD 1074 | $1'' \times 3''$



SWD 1075 | $\frac{3}{4}'' \times 5''$



SWD 1076 | $\frac{3}{4}'' \times 3\frac{1}{2}''$

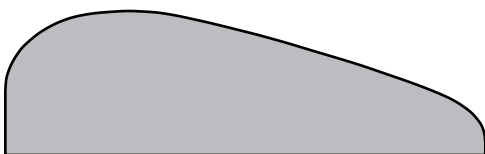

SWD 1077 | $\frac{3}{4}'' \times 2\frac{1}{2}''$



SWD 1078 | $\frac{3}{4}'' \times$ Customer Specs

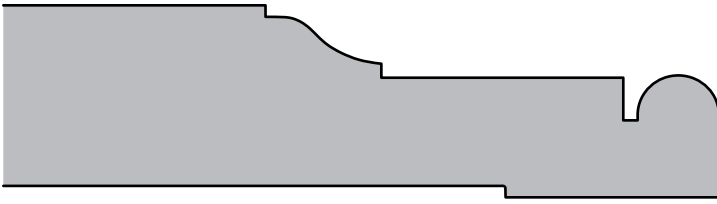

SWD 1079 | 1" x Customer Specs

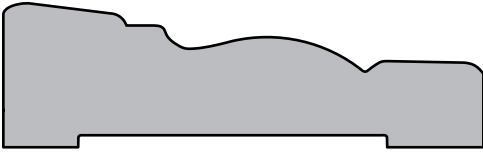

SWD 1080 | $\frac{3}{4}$ " x $2\frac{1}{2}$ "



SWD 1081 | $\frac{3}{4}$ " x $3\frac{5}{8}$ "



SWD 1082 | $\frac{3}{4}$ " x $2\frac{1}{2}$ "



SWD 1083 | $\frac{7}{8}$ " x $6\frac{1}{16}$ "

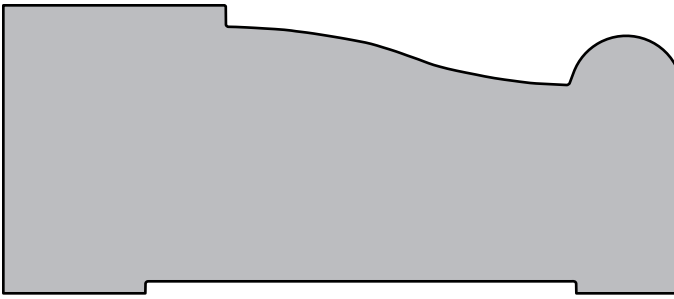

SWD 1084 | $1\frac{1}{2}'' \times 3\frac{1}{2}''$

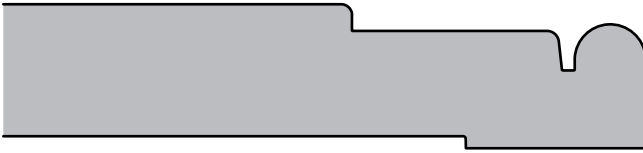

SWD 1085 | $\frac{3}{4}'' \times$ Customer Specs

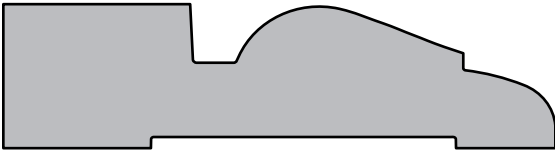

SWD 1086 | $\frac{3}{4}'' \times 2\frac{7}{8}''$

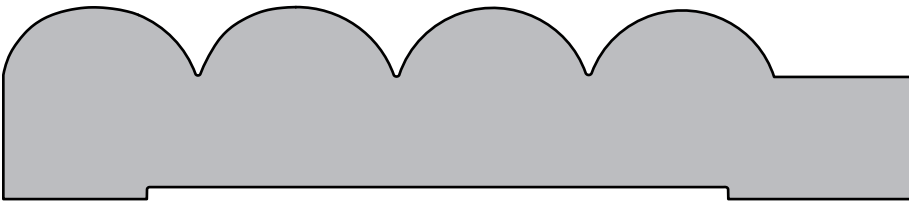

SWD 1087 | $1'' \times 4\frac{3}{4}''$

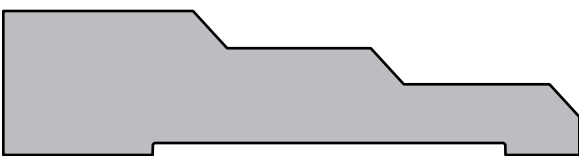

SWD 1088 | $\frac{3}{4}'' \times 3''$

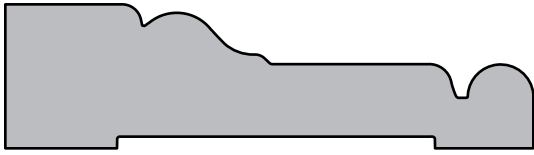

SWD 1089 | $\frac{3}{4}'' \times 2\frac{3}{4}''$

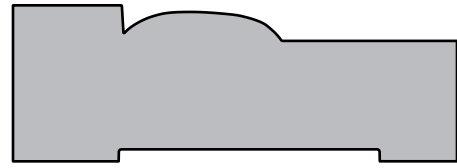

SWD 1090 | $1\frac{3}{16}'' \times 2\frac{5}{16}''$

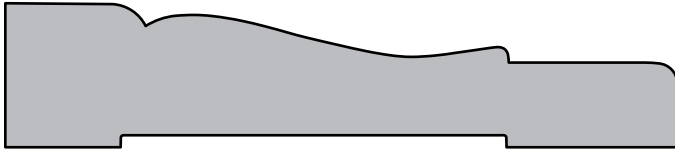

SWD 1091 | $\frac{3}{4}'' \times 3\frac{1}{2}''$

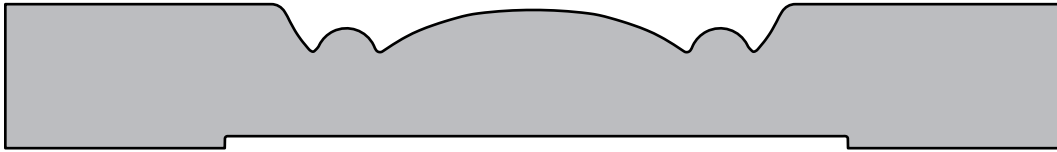

SWD 1092 | $\frac{3}{4}'' \times 5\frac{1}{2}''$



SWD 1093 | $\frac{3}{4}'' \times 5\frac{1}{2}''$

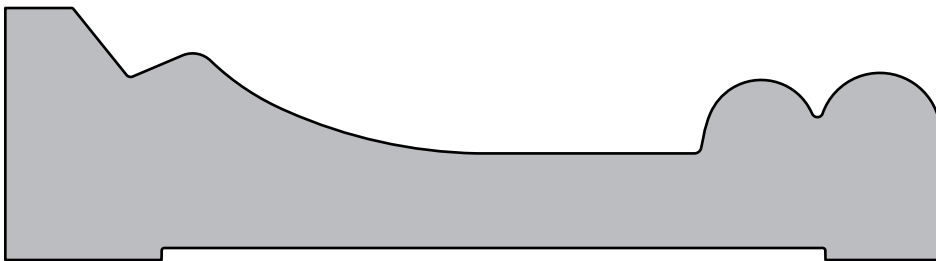

SWD 1094 | $1\frac{5}{16}'' \times 4\frac{7}{8}''$

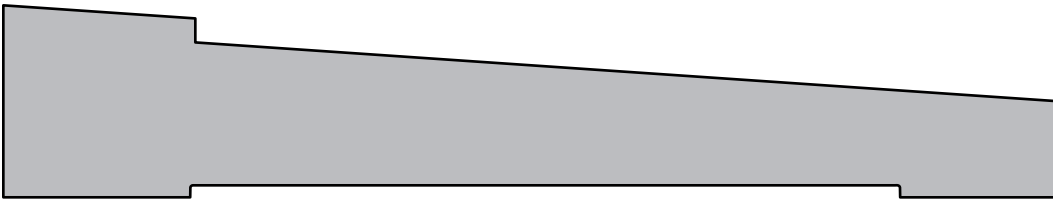

SWD 1095 | 1" x 5½"

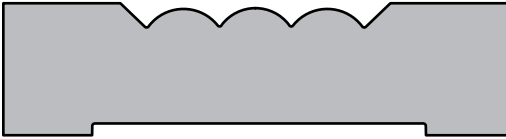

SWD 1096 | 1½" x 2⅝"

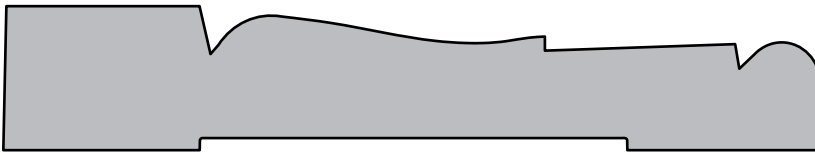

SWD 1097 | ¾" x 4¼"

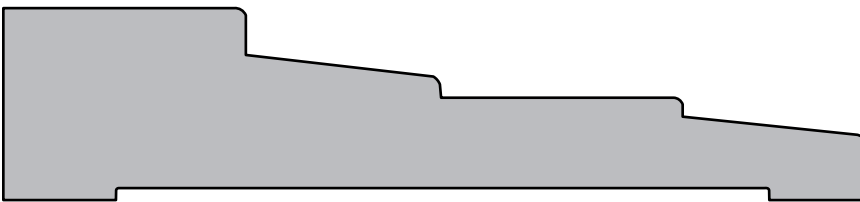

SWD 1098 | 1" x 4½"



SWD 1099 | ¾" x 3¾"

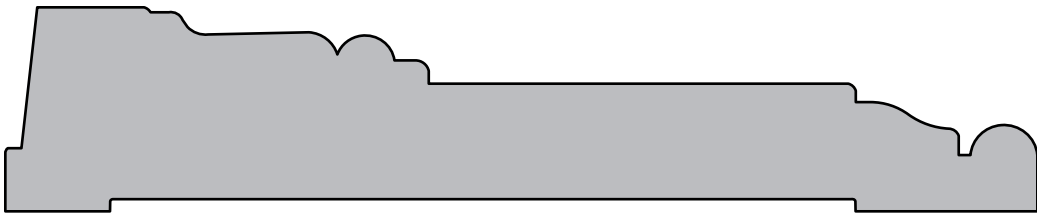

SWD 1100 | $1\frac{1}{16}'' \times 5\frac{3}{8}''$

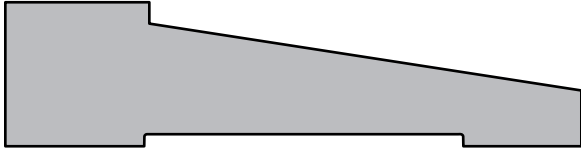

SWD 1101 | $\frac{3}{4}'' \times 3''$

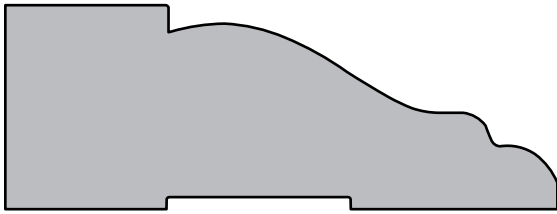

SWD 1102 | $1\frac{1}{16}'' \times 2\frac{7}{8}''$

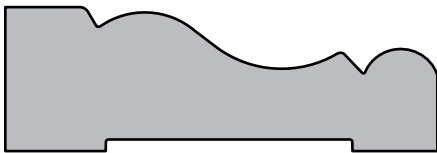

SWD 1103 | $\frac{3}{4}'' \times 2\frac{1}{4}''$

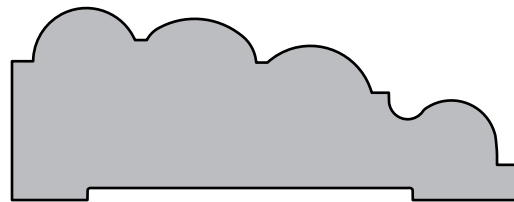

SWD 1104 | $1'' \times 2\frac{5}{8}''$

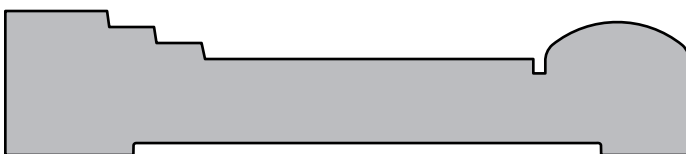

SWD 1105 | $\frac{3}{4}'' \times 3\frac{9}{16}''$

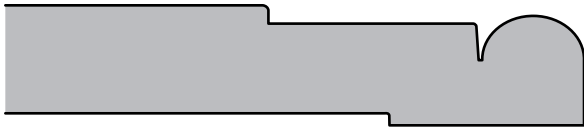

SWD 1106 | $\frac{5}{8}$ " x Customer Specs

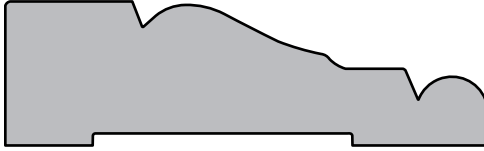

SWD 1107 | $\frac{3}{4}$ " x $2\frac{1}{2}$ "

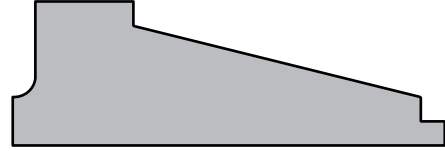

SWD 1108 | $\frac{3}{4}$ " x $2\frac{1}{4}$ "

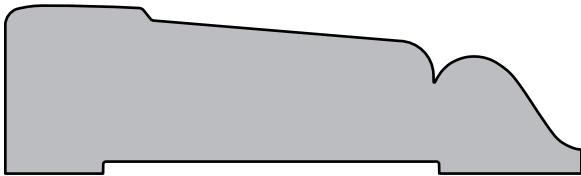

SWD 1109 | $\frac{7}{8}$ " x 3"



SWD 1110 | $\frac{3}{4}$ " x $4\frac{1}{2}$ "

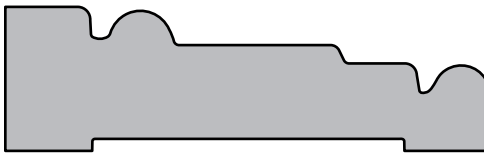

SWD 1111 | $\frac{3}{4}$ " x $2\frac{1}{2}$ "

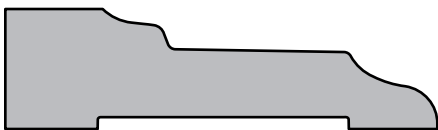

SWD 1112 | $\frac{5}{8}$ " x $2\frac{1}{4}$ "

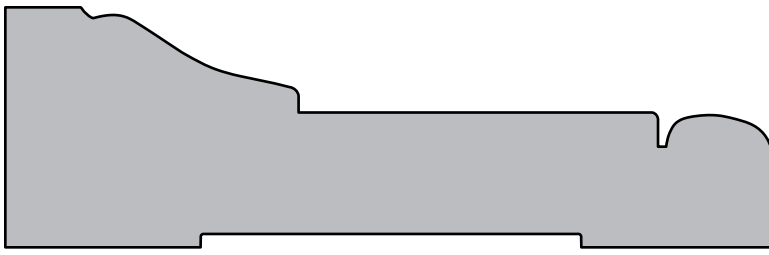

SWD 1113 | $1\frac{1}{4}'' \times 4''$



SWD 1114 | $\frac{1}{2}'' \times 5\frac{1}{2}''$



SWD 1115 | $\frac{3}{4}'' \times 2\frac{3}{4}''$

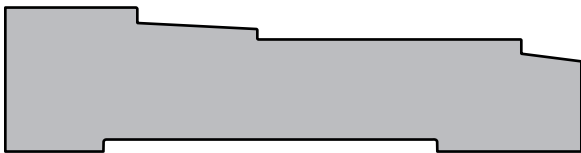

SWD 1116 | $\frac{3}{4}'' \times 3''$

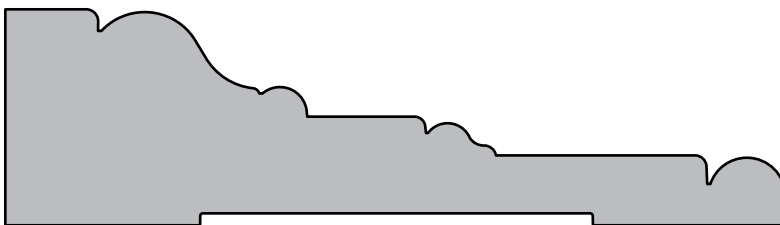

SWD 1117 | $1\frac{1}{8}'' \times 4\frac{1}{16}''$

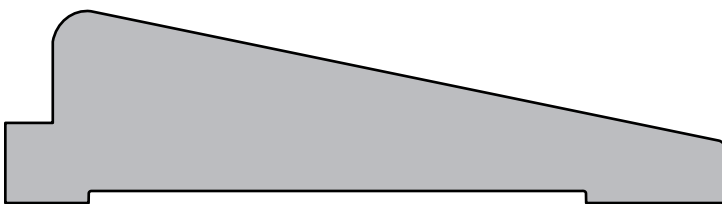

SWD 1118 | $1'' \times 3\frac{3}{4}''$

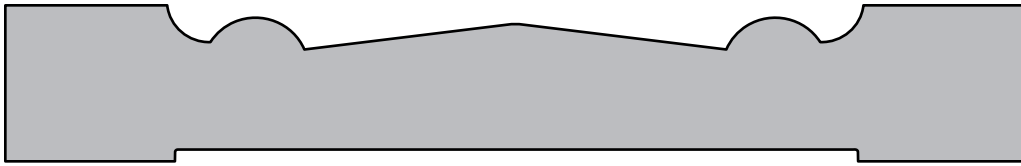

SWD 1119 | $1\frac{3}{16}'' \times 5\frac{5}{16}''$

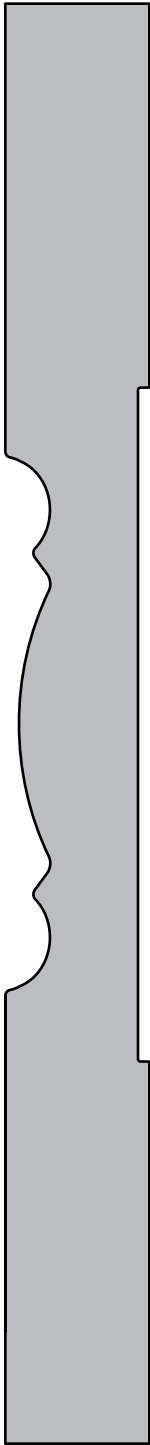

SWD 1120 | $\frac{3}{4}'' \times 7\frac{1}{2}''$

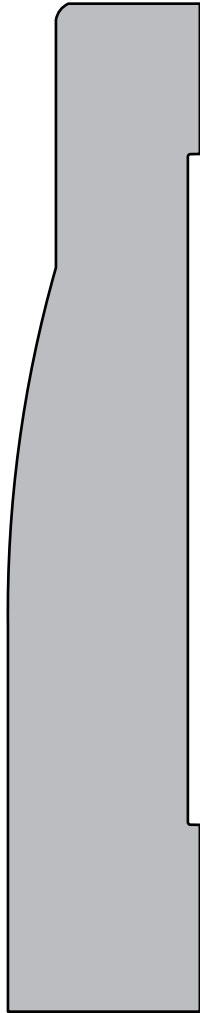

SWD 1121 | $1'' \times 5\frac{1}{4}''$

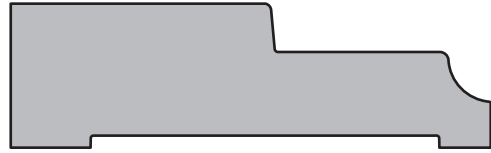

SWD 1122 | $\frac{3}{4}'' \times 2\frac{1}{2}''$

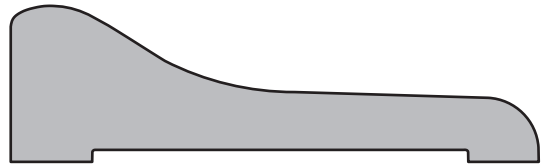

SWD 1123 | $1\frac{3}{16}'' \times 2\frac{3}{4}''$

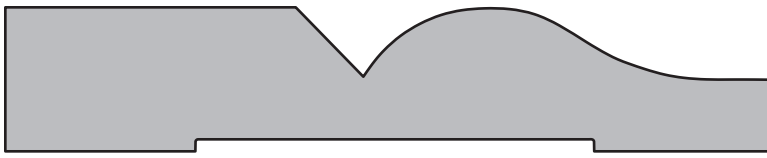

SWD 1124 | $\frac{3}{4}$ " x 4"

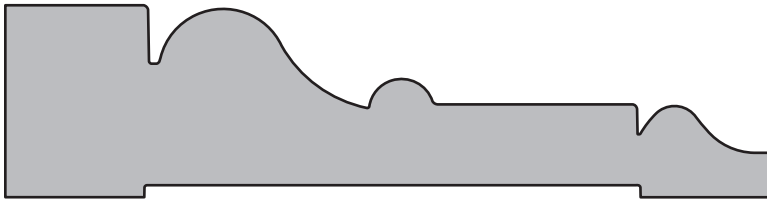

SWD 1125 | 1" x 4"

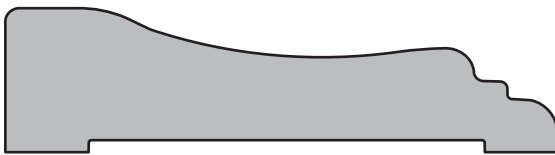

SWD 1126 | $\frac{3}{4}$ " x $2\frac{7}{8}$ "

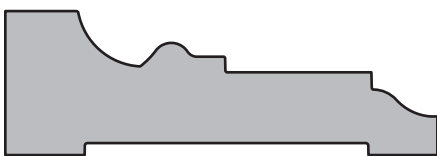

SWD 1127 | $\frac{3}{4}$ " x $2\frac{1}{4}$ "



SWD 1128 | 1" x 4"



SWD 1129 | $1\frac{1}{4}'' \times 4''$

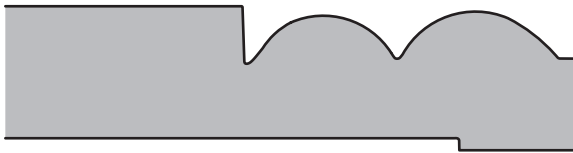

SWD 1130 | $\frac{3}{4}'' \times$ Customer Specs

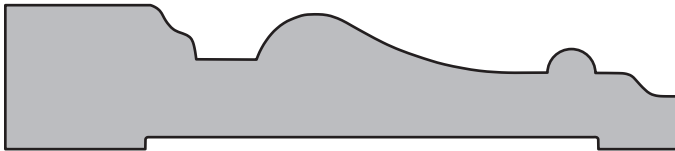

SWD 1131 | $\frac{3}{4}'' \times 3\frac{1}{2}''$



SWD 1132 | $\frac{5}{8}'' \times 2\frac{1}{2}''$



SWD 1133 | $1\frac{1}{16}'' \times 4\frac{7}{16}''$

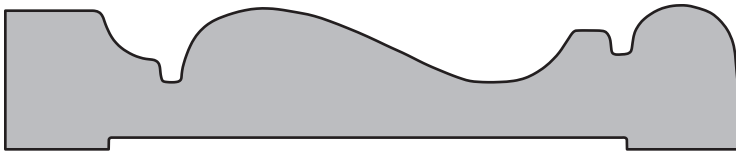

SWD 1134 | $\frac{3}{4}'' \times 3\frac{13}{16}''$



SWD 1135 | $1\frac{1}{16}'' \times 5\frac{9}{16}''$

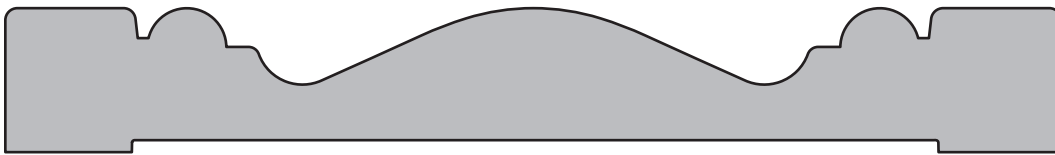

SWD 1136 | $\frac{3}{4}'' \times 5\frac{1}{2}''$



SWD 1137 | $\frac{3}{4}'' \times 4\frac{1}{2}''$

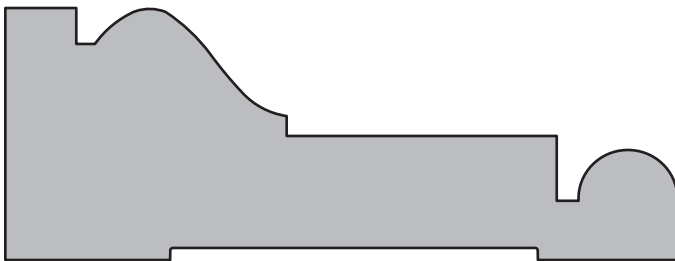

SWD 1138 | $1\frac{5}{16}'' \times 3\frac{1}{2}''$

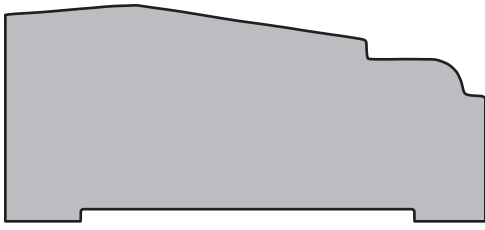

SWD 1139 | $1\frac{1}{8}'' \times 2\frac{1}{2}''$

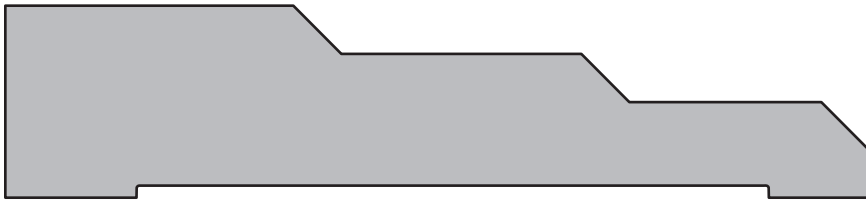

SWD 1140 | $1'' \times 4\frac{1}{2}''$

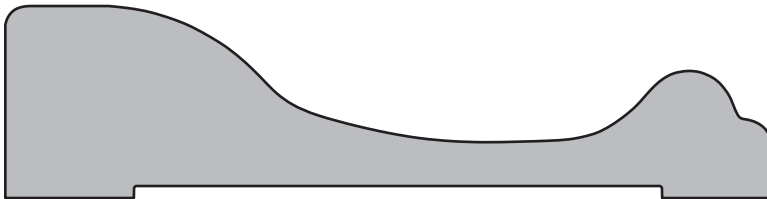

SWD 1141 | $1'' \times 4''$



SWD 1143 | $\frac{3}{4}'' \times 2\frac{1}{4}''$

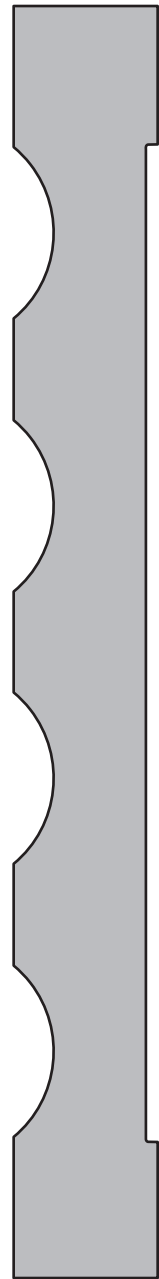

SWD 1142 | $\frac{3}{4}'' \times 6\frac{5}{8}''$

SECTION 2

Base Profiles

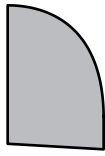

SWD 200 | $\frac{1}{2}'' \times \frac{3}{4}''$



SWD 201 | $\frac{1}{16}'' \times$ Customer Specs



SWD 202 | $\frac{1}{16}'' \times$ Customer Specs



SWD 203 | $\frac{1}{16}'' \times$ Customer Specs



SWD 204 | $\frac{1}{16}'' \times$ Customer Specs



SWD 205 | $\frac{1}{16}'' \times$ Customer Specs | $\frac{1}{4}''$ Radius



SWD 206 | $1\frac{1}{16}$ " x Customer Specs | $\frac{3}{8}$ " Radius



SWD 207 | $1\frac{1}{16}$ " x Customer Specs | $\frac{1}{2}$ " Radius



SWD 208 | $1\frac{1}{16}$ " x Customer Specs | $1\frac{1}{16}$ " Radius



SWD 209 | $1\frac{1}{16}$ " x Customer Specs | $1\frac{1}{8}$ " Radius

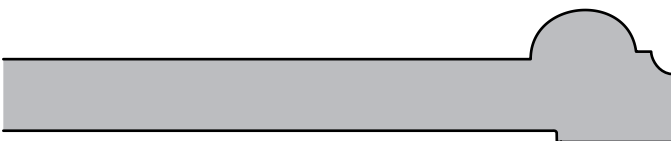

SWD 210 | $1\frac{1}{16}$ " x Customer Specs



SWD 211 | $1\frac{1}{16}$ " x Customer Specs

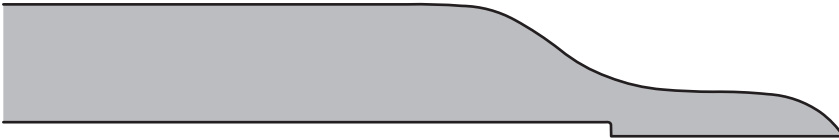

SWD 212 | $1\frac{1}{16}$ " x Customer Specs



SWD 213 | $1\frac{1}{16}$ " x Customer Specs



SWD 214 | $1\frac{1}{16}$ " x Customer Specs



SWD 215 | $1\frac{1}{16}$ " x Customer Specs



SWD 216 | $1\frac{1}{16}$ " x Customer Specs



SWD 217 | $1\frac{1}{16}$ " x Customer Specs

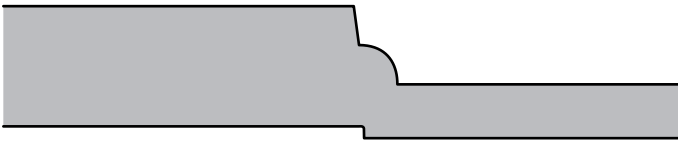

SWD 218 | $1\frac{1}{16}$ " x Customer Specs



SWD 219 | $1\frac{1}{16}$ " x Customer Specs



SWD 220 | $1\frac{1}{16}$ " x Customer Specs

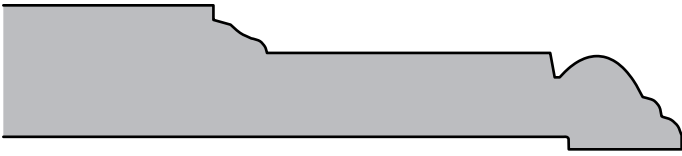

SWD 221 | $\frac{3}{4}$ " x Customer Specs



SWD 222 | $\frac{1}{16}$ " x Customer Specs

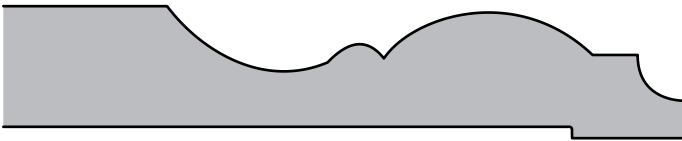

SWD 223 | $\frac{1}{16}$ " x Customer Specs



SWD 224 | $\frac{1}{16}$ " x Customer Specs



SWD 225 | $\frac{1}{16}$ " x Customer Specs

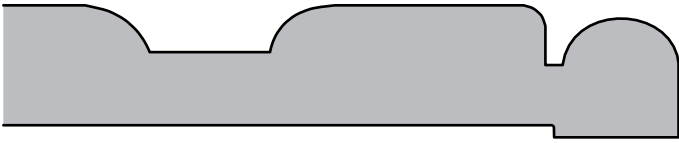

SWD 226 | $1\frac{1}{16}$ " x Customer Specs

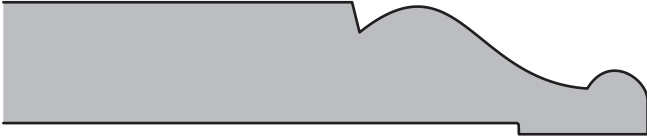

SWD 227 | $1\frac{1}{16}$ " x Customer Specs



SWD 228 | $1\frac{1}{16}$ " x Customer Specs

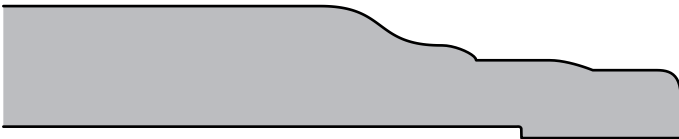

SWD 229 | $1\frac{1}{16}$ " x Customer Specs



SWD 230 | $1\frac{1}{16}$ " x Customer Specs



SWD 231 | $1\frac{1}{16}$ " x Customer Specs



SWD 232 | $1\frac{1}{16}$ " x Customer Specs



SWD 233 | 1" x Customer Specs



SWD 234 | $1\frac{1}{16}$ " x Customer Specs



SWD 235 | $1\frac{1}{16}$ " x Customer Specs

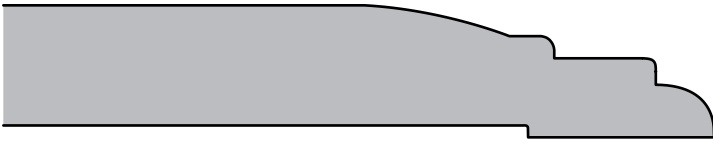

SWD 236 | $1\frac{1}{16}$ " x Customer Specs



SWD 237 | $1\frac{1}{16}$ " x Customer Specs



SWD 238 | $1\frac{1}{16}$ " x Customer Specs



SWD 239 | $1\frac{1}{16}$ " x Customer Specs

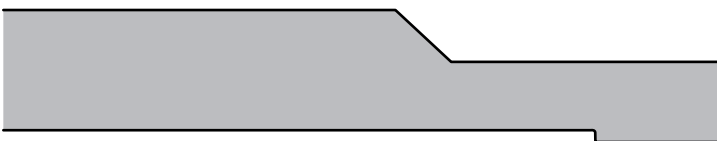

SWD 240 | $1\frac{1}{16}$ " x Customer Specs

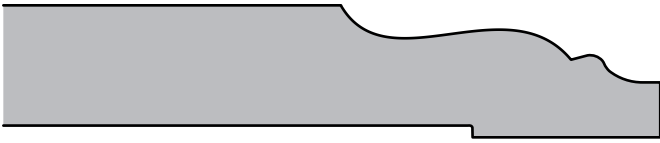

SWD 241 | $1\frac{1}{16}$ " x Customer Specs



SWD 242 | $1\frac{1}{16}$ " x Customer Specs



SWD 243 | $1\frac{1}{16}$ " x Customer Specs



SWD 244 | $1\frac{1}{16}$ " x Customer Specs



SWD 245 | $1\frac{1}{16}$ " x Customer Specs



SWD 246 | $1\frac{1}{16}$ " x Customer Specs



SWD 247 | $1\frac{1}{16}$ " x Customer Specs



SWD 248 | $1\frac{1}{16}$ " x Customer Specs



SWD 249 | $1\frac{1}{16}$ " x Customer Specs



SWD 250 | $1\frac{1}{16}$ " x Customer Specs



SWD 251 | $1\frac{1}{16}$ " x Customer Specs

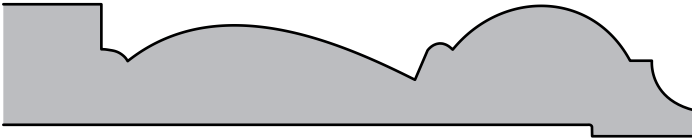

SWD 252 | $1\frac{1}{16}$ " x Customer Specs

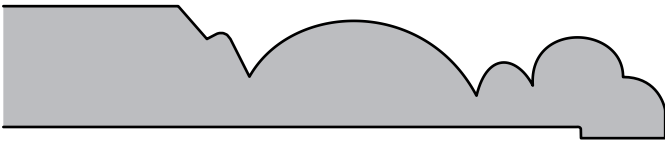

SWD 253 | $1\frac{1}{16}$ " x Customer Specs



SWD 254 | $1\frac{1}{16}$ " x Customer Specs



SWD 255 | $1\frac{1}{16}$ " x Customer Specs

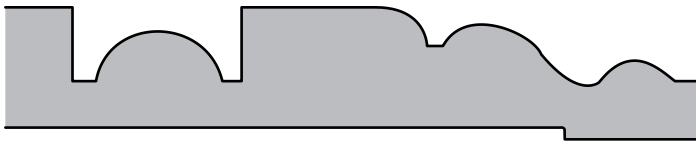

SWD 256 | $1\frac{1}{16}$ " x Customer Specs



SWD 257 | $1\frac{1}{16}$ " x Customer Specs

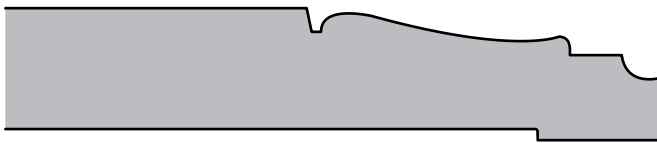

SWD 258 | $1\frac{1}{16}$ " x Customer Specs



SWD 259 | $1\frac{1}{16}$ " x Customer Specs



SWD 260 | $1\frac{1}{16}$ " x Customer Specs



SWD 261 | $1\frac{1}{16}$ " x Customer Specs

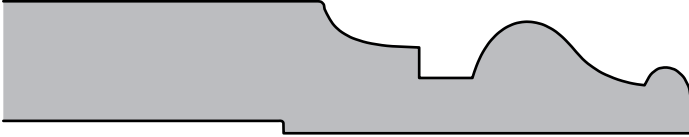

SWD 262 | $1\frac{1}{16}$ " x Customer Specs

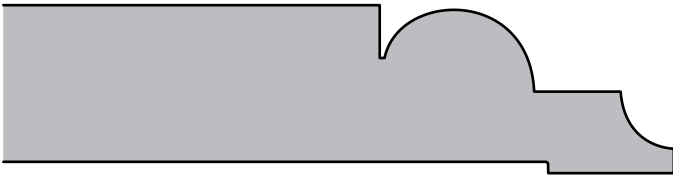

SWD 263 | $\frac{7}{8}$ " x Customer Specs



SWD 264 | $1\frac{1}{16}$ " x Customer Specs



SWD 265 | $1\frac{1}{16}$ " x Customer Specs

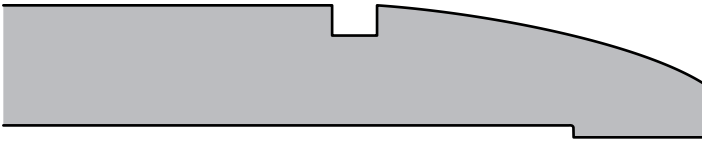

SWD 266 | $1\frac{1}{16}$ " x Customer Specs



SWD 267 | $1\frac{1}{16}$ " x Customer Specs



SWD 268 | $1\frac{1}{16}$ " x Customer Specs

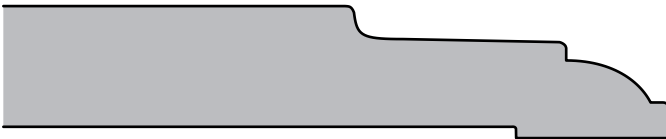

SWD 269 | $1\frac{1}{16}$ " x Customer Specs



SWD 270 | $1\frac{1}{16}$ " x Customer Specs



SWD 271 | $1\frac{1}{16}$ " x Customer Specs



SWD 272 | $1\frac{1}{16}$ " x Customer Specs



SWD 273 | $1\frac{1}{16}$ " x Customer Specs



SWD 274 | $1\frac{1}{16}$ " x Customer Specs



SWD 275 | $\frac{3}{4}$ " x Customer Specs



SWD 276 | $1\frac{1}{16}$ " x Customer Specs



SWD 277 | $1\frac{1}{16}$ " x Customer Specs



SWD 278 | $1\frac{1}{16}$ " x Customer Specs



SWD 279 | $1\frac{1}{16}$ " x Customer Specs

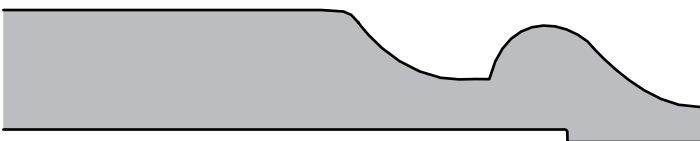

SWD 280 | $1\frac{1}{16}$ " x Customer Specs



SWD 281 | $1\frac{1}{16}$ " x Customer Specs

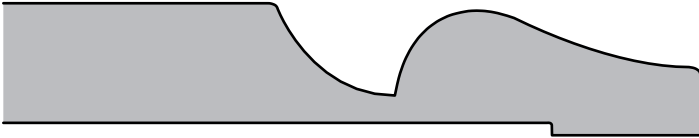

SWD 282 | $1\frac{1}{16}$ " x Customer Specs

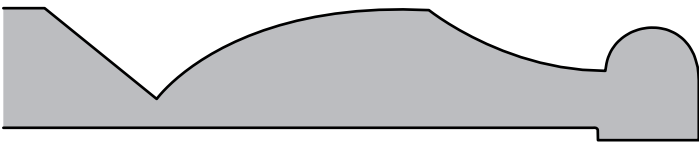

SWD 283 | $1\frac{1}{16}$ " x Customer Specs

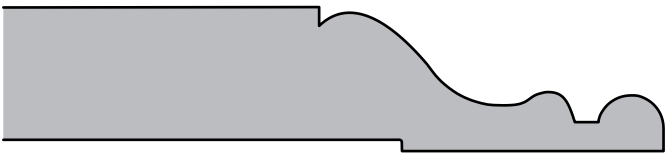

SWD 284 | $\frac{3}{4}$ " x Customer Specs



SWD 285 | $1\frac{1}{16}$ " x Customer Specs

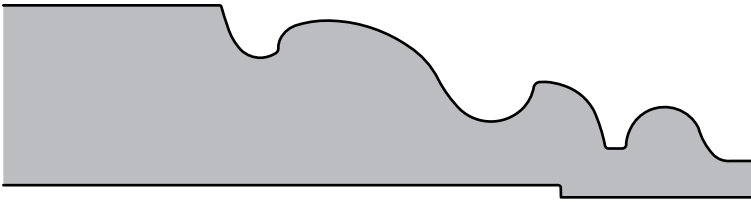

SWD 286 | 1" x Customer Specs



SWD 287 | 1¹/₁₆" x Customer Specs

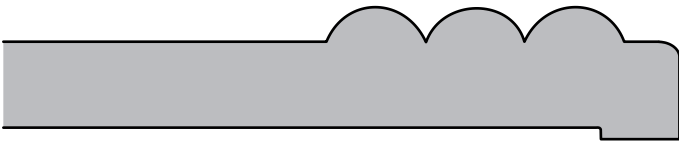

SWD 288 | 1¹/₁₆" x Customer Specs

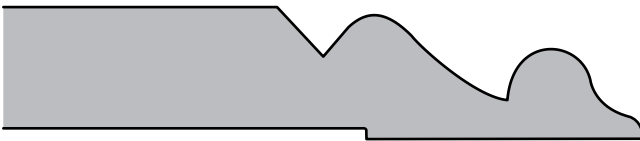

SWD 289 | 3/4" x Customer Specs

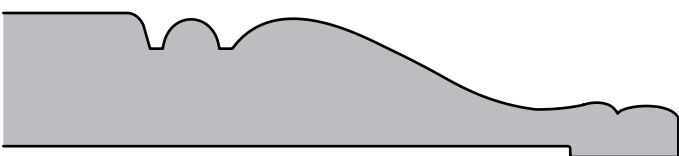

SWD 290 | 3/4" x Customer Specs



SWD 291 | $1\frac{1}{16}$ " x Customer Specs



SWD 292 | $1\frac{1}{16}$ " x Customer Specs

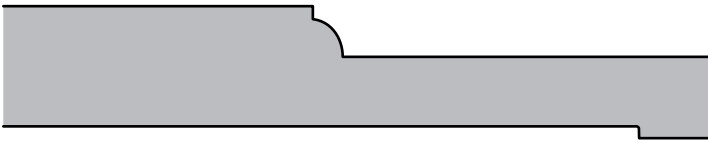

SWD 293 | $1\frac{1}{16}$ " x Customer Specs



SWD 294 | $1\frac{1}{16}$ " x Customer Specs

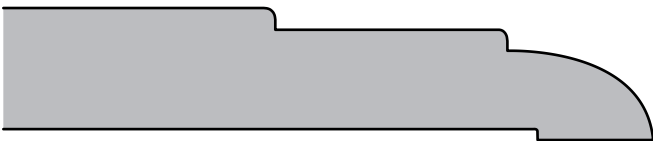

SWD 295 | $1\frac{1}{16}$ " x Customer Specs

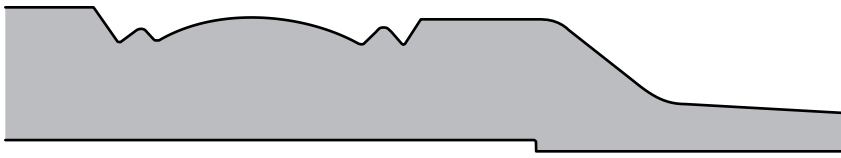

SWD 296 | $\frac{3}{4}$ " x Customer Specs

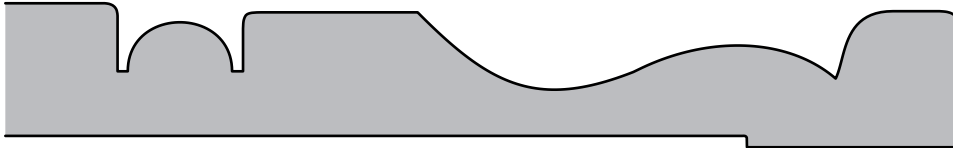

SWD 297 | $\frac{3}{4}$ " x Customer Specs

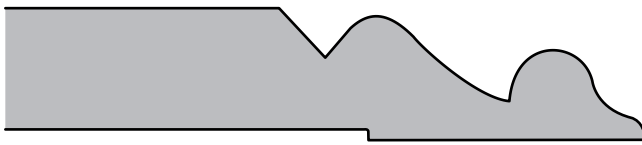

SWD 298 | $\frac{1}{16}$ " x Customer Specs

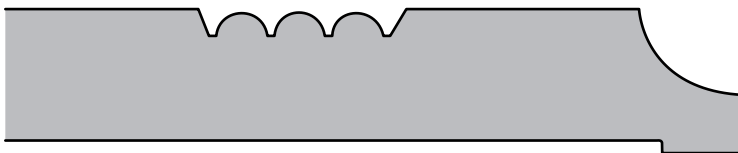

SWD 299 | $\frac{3}{4}$ " x Customer Specs

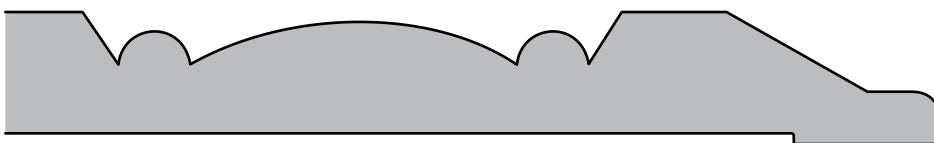

SWD 2000 | $\frac{1}{16}$ " x Customer Specs



SWD 2001 | $1\frac{1}{16}$ " x Customer Specs



SWD 2002 | $1\frac{1}{16}$ " x Customer Specs



SWD 2003 | $1\frac{1}{16}$ " x Customer Specs



SWD 2004 | $1\frac{1}{16}$ " x Customer Specs

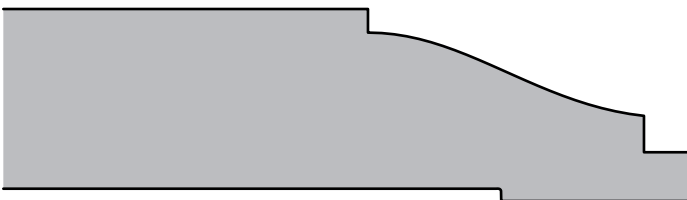

SWD 2005 | 1" x Customer Specs

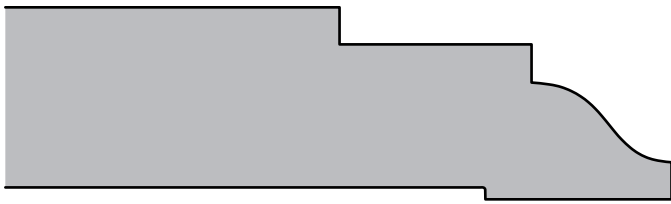

SWD 2006 | 1" x Customer Specs

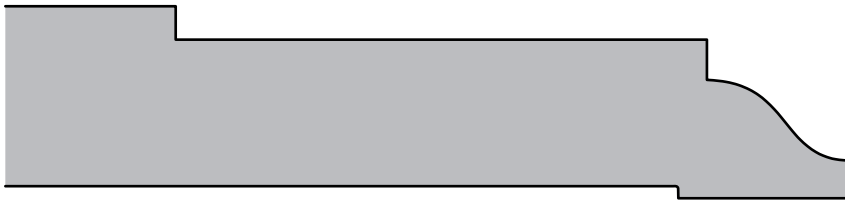

SWD 2007 | 1" x Customer Specs



SWD 2008 | 1 $\frac{1}{16}$ " x Customer Specs



SWD 2009 | 1 $\frac{1}{16}$ " x Customer Specs

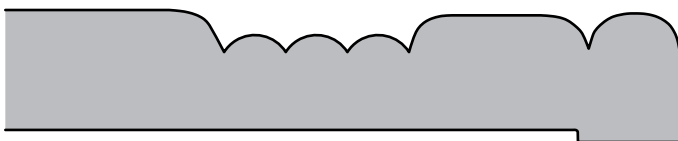

SWD 2011 | 1 $\frac{1}{16}$ " x Customer Specs

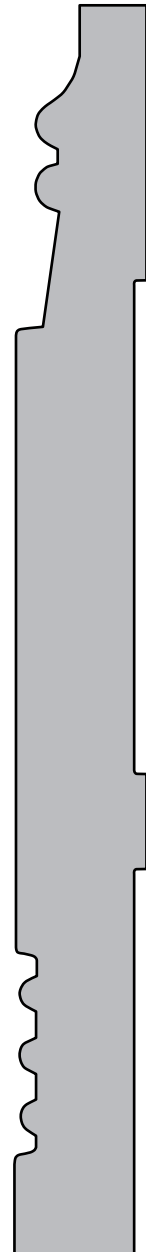

SWD 2010
1 $\frac{1}{16}$ " x Customer Specs



SWD 2012 | $1\frac{1}{16}$ " x Customer Specs



SWD 2013 | $1\frac{1}{16}$ " x Customer Specs



SWD 2014 | $1\frac{1}{16}$ " x Customer Specs

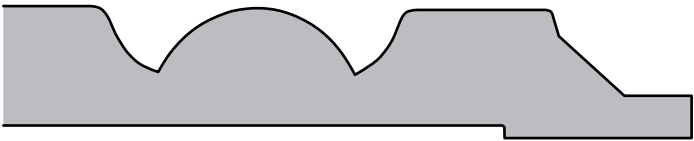

SWD 2015 | $1\frac{1}{16}$ " x Customer Specs



SWD 2016 | $1\frac{1}{16}$ " x Customer Specs



SWD 2017 | $1\frac{1}{16}$ " x Customer Specs



SWD 2018 | $1\frac{1}{16}$ " x Customer Specs



SWD 2019 | $1\frac{1}{16}$ " x Customer Specs



SWD 2020 | $1\frac{1}{16}$ " x Customer Specs



SWD 2021 | $1\frac{3}{16}$ " x Customer Specs



SWD 2022 | $1\frac{1}{16}$ " x Customer Specs

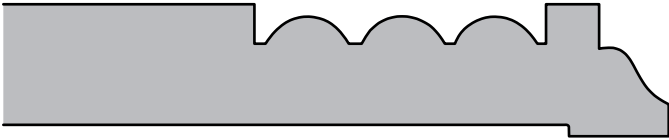

SWD 2023 | $1\frac{1}{16}$ " x Customer Specs



SWD 2024 | $1\frac{1}{16}$ " x Customer Specs



SWD 2025 | $1\frac{1}{16}$ " x Customer Specs



SWD 2026 | $1\frac{1}{16}$ " x Customer Specs



SWD 2027 | $1\frac{1}{16}$ " x Customer Specs

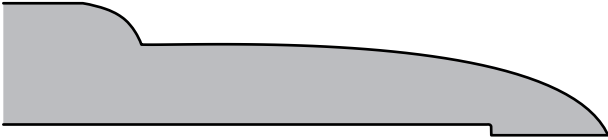

SWD 2028 | $1\frac{1}{16}$ " x Customer Specs



SWD 2029 | $1\frac{1}{16}$ " x Customer Specs



SWD 2030 | $\frac{3}{4}$ " x Customer Specs



SWD 2031 | $1\frac{1}{16}$ " x Customer Specs



SWD 2032 | $1\frac{1}{16}$ " x Customer Specs



SWD 2033 | $1\frac{1}{16}$ " x Customer Specs



SWD 2034 | $1\frac{1}{16}$ " x Customer Specs

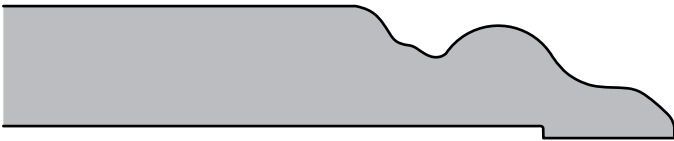

SWD 2035 | $1\frac{1}{16}$ " x Customer Specs



SWD 2036 | $\frac{3}{4}$ " x Customer Specs

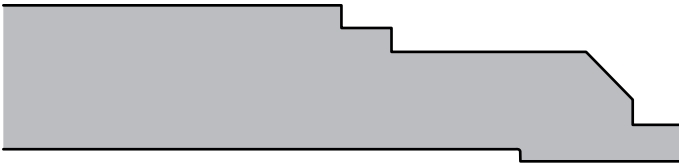

SWD 2037 | $1\frac{3}{16}$ " x Customer Specs



SWD 2038 | $1\frac{1}{16}$ " x Customer Specs



SWD 2039 | $1\frac{1}{16}$ " x Customer Specs



SWD 2040 | $1\frac{1}{16}$ " x Customer Specs

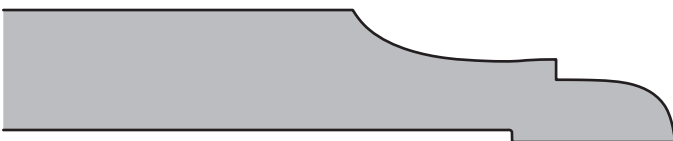

SWD 2041 | $1\frac{1}{16}$ " x Customer Specs



SWD 2042 | $1\frac{1}{16}$ " x Customer Specs

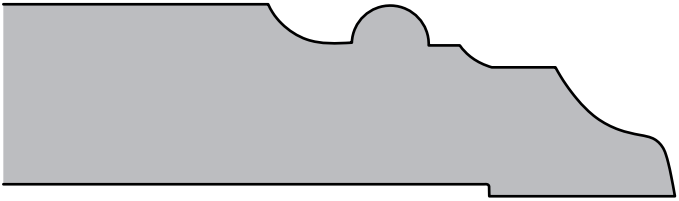

SWD 2043 | 1" x Customer Specs

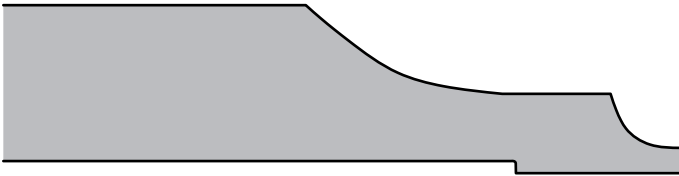

SWD 2044 | $\frac{7}{8}$ " x Customer Specs



SWD 2045 | $1\frac{1}{16}$ " x Customer Specs



SWD 2046 | $1\frac{1}{16}$ " x Customer Specs



SWD 2047 | $1\frac{1}{16}$ " x Customer Specs

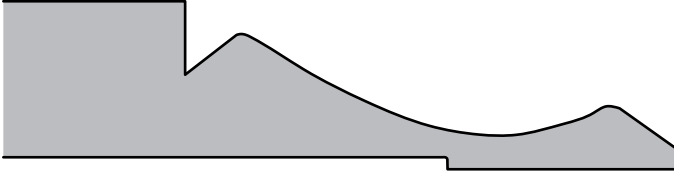

SWD 2048 | $\frac{7}{8}$ " x Customer Specs



SWD 2049 | $1\frac{1}{16}$ " x Customer Specs

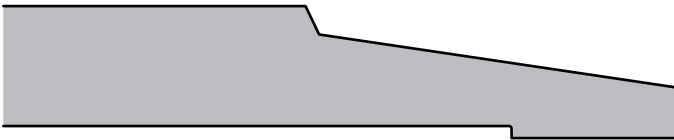

SWD 2050 | $1\frac{1}{16}$ " x Customer Specs



SWD 2051 | $1\frac{1}{16}$ " x Customer Specs



SWD 2052 | $1\frac{1}{16}$ " x Customer Specs



SWD 2053 | $1\frac{1}{16}$ " x Customer Specs

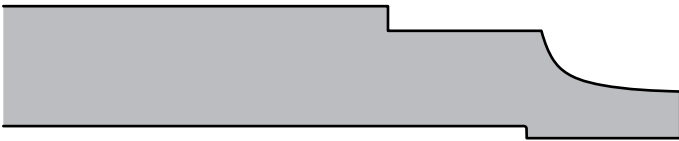

SWD 2054 | $1\frac{1}{16}$ " x Customer Specs

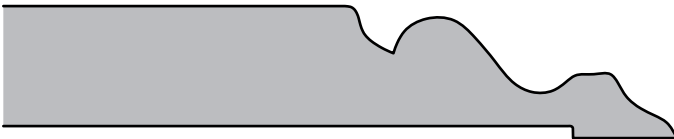

SWD 2055 | $1\frac{1}{16}$ " x Customer Specs



SWD 2056 | $1\frac{1}{16}$ " x Customer Specs



SWD 2057 | $1\frac{1}{16}$ " x Customer Specs

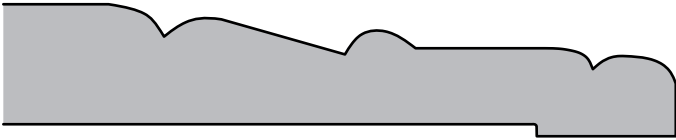

SWD 2058 | $1\frac{1}{16}$ " x Customer Specs

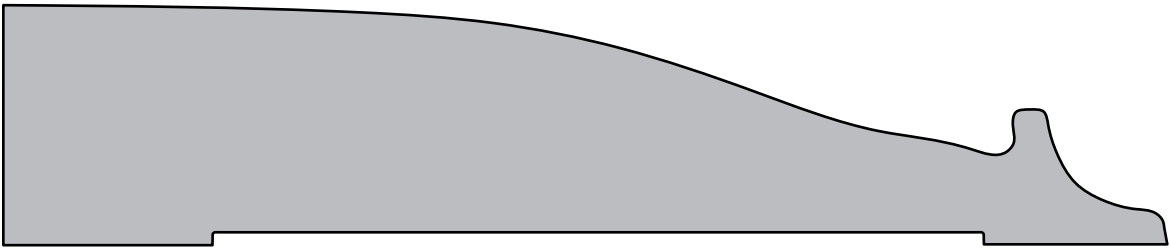

SWD 2059 | $1\frac{1}{4}$ " x $6\frac{1}{16}$ "

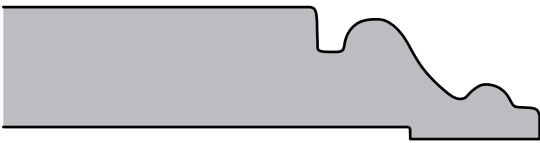

SWD 2060 | $1\frac{1}{16}$ " x Customer Specs

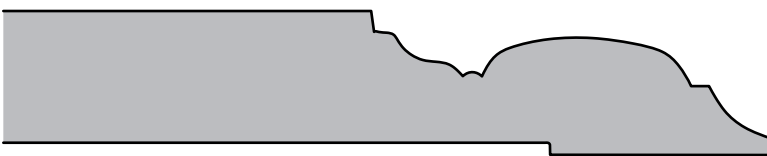

SWD 2061 | $\frac{3}{4}$ " x Customer Specs



SWD 2062 | $\frac{3}{4}$ " x Customer Specs



SWD 2063 | $\frac{9}{16}$ " x Customer Specs



SWD 2064 | $1\frac{1}{16}$ " x Customer Specs

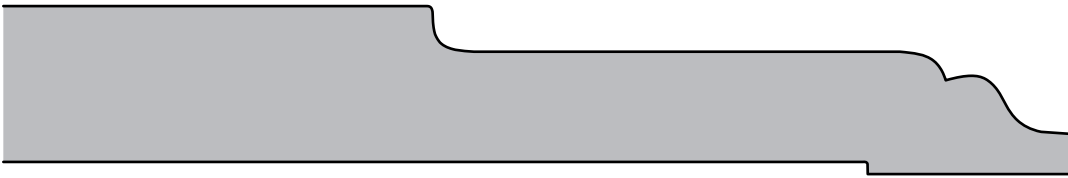

SWD 2065 | $\frac{7}{8}$ " x Customer Specs

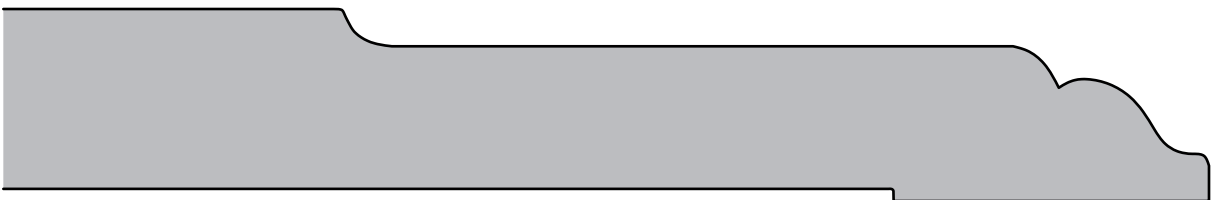

SWD 2066 | 1" x Customer Specs



SWD 2067 | $\frac{3}{4}$ " x Customer Specs



SWD 2068 | $1\frac{1}{16}$ " x Customer Specs



SWD 2069 | $1\frac{1}{16}$ " x Customer Specs

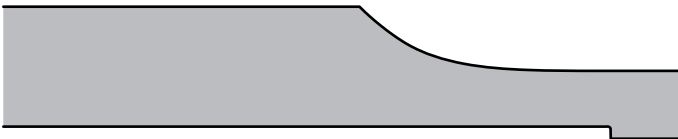

SWD 2070 | $1\frac{1}{16}$ " x Customer Specs



SWD 2071 | $1\frac{1}{16}$ " x Customer Specs



SWD 2072 | $1\frac{1}{16}$ " x Customer Specs



SWD 2073 | $1\frac{1}{16}$ " x Customer Specs

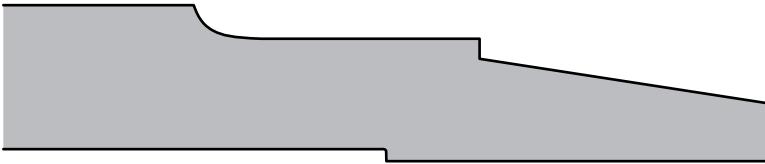

SWD 2074 | $1\frac{3}{16}$ " x Customer Specs



SWD 2075 | $1\frac{1}{16}$ " x Customer Specs



SWD 2076 | $\frac{3}{4}$ " x Customer Specs

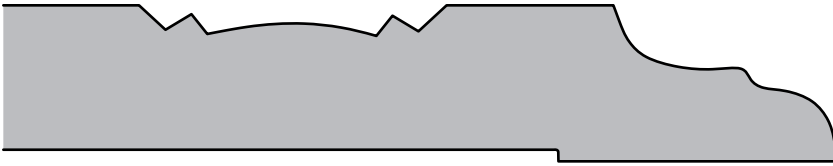

SWD 2077 | $1\frac{3}{16}$ " x Customer Specs



SWD 2078 | $\frac{3}{4}$ " x Customer Specs



SWD 2079 | $1\frac{1}{16}$ " x Customer Specs



SWD 2080 | $\frac{5}{8}$ " x Customer Specs



SWD 2081 | $1\frac{3}{16}$ " x Customer Specs



SWD 2082 | $\frac{3}{4}$ " x Customer Specs



SWD 2083 | $\frac{3}{4}$ " x Customer Specs



SWD 2084 | $\frac{3}{4}$ " x Customer Specs

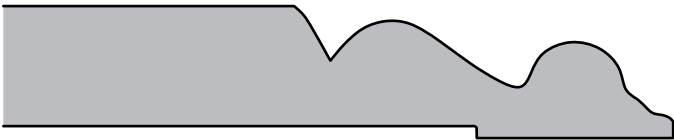

SWD 2085 | $1\frac{1}{16}$ " x Customer Specs



SWD 2086 | $1\frac{1}{16}$ " x Customer Specs



SWD 2087 | $\frac{3}{4}$ " x Customer Specs



SWD 2088 | $\frac{5}{8}$ " x Customer Specs



SWD 2089 | $\frac{3}{4}$ " x Customer Specs

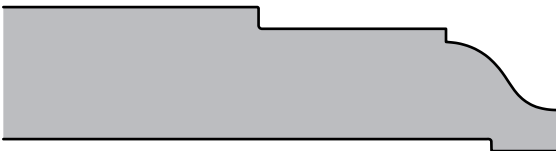

SWD 2090 | $\frac{3}{4}$ " x Customer Specs



SWD 2091 | $\frac{5}{8}$ " x Customer Specs



SWD 2092 | $1\frac{1}{16} \times 6\frac{1}{2}$ "



SWD 2093 | $\frac{3}{4}$ " x Customer Specs



SWD 2094 | $\frac{3}{4}$ " x Customer Specs



SWD 2095 | $\frac{3}{4}$ " x Customer Specs



SWD 2096 | $\frac{3}{4}$ " x Customer Specs



SWD 2097 | $\frac{7}{8}''$ x $3\frac{3}{8}''$



SWD 2098 | $\frac{3}{4}''$ x Customer Specs

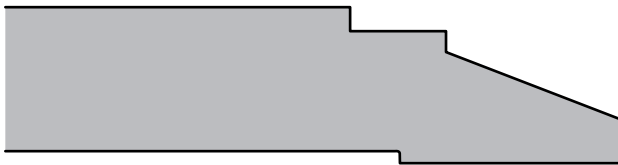

SWD 2099 | $1\frac{3}{16}''$ x Customer Specs

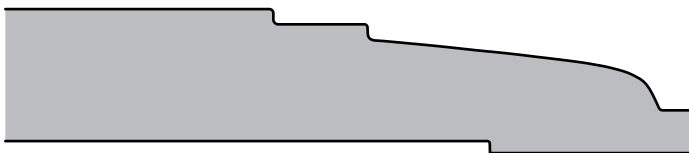

SWD 2100 | $\frac{3}{4}''$ x Customer Specs



SWD 2101 | $\frac{5}{8}''$ x Customer Specs

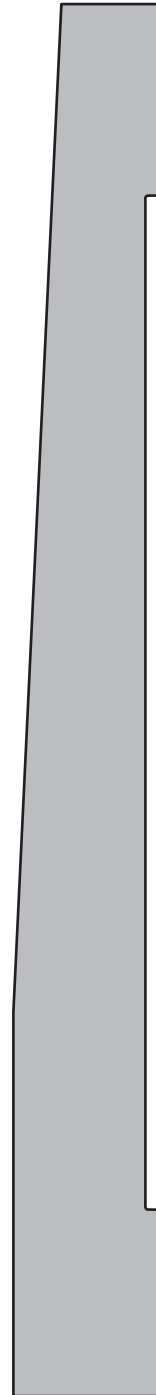

SWD 2102 | $\frac{3}{4}''$ x $7\frac{1}{4}''$



SWD 2103 | $1\frac{1}{16}$ " x Customer Specs



SWD 2104 | $\frac{3}{4}$ " x Customer Specs



SWD 2105 | $1\frac{1}{16}$ " x Customer Specs



SWD 2106 | $1\frac{3}{16}$ " x Customer Specs

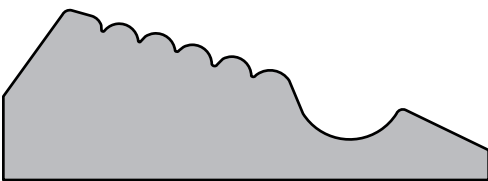

SWD 2107 | $\frac{7}{8}$ " x $2\frac{1}{2}$ "



SWD 2108 | $\frac{5}{8}$ " x Customer Specs

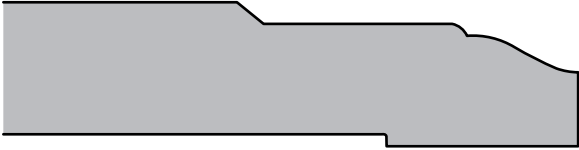

SWD 2109 | $\frac{3}{4}$ " x Customer Specs



SWD 2110 | $\frac{9}{16}$ " x Customer Specs

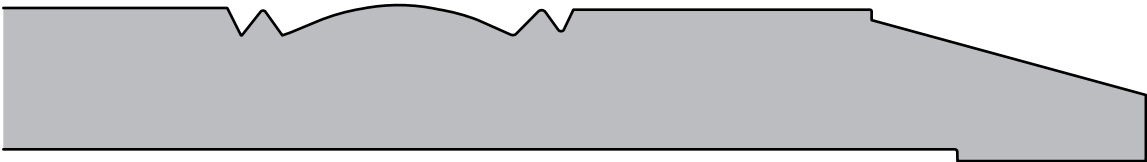

SWD 2111 | $\frac{13}{16}$ " x Customer Specs



SWD 2113 | $\frac{11}{16}$ " x Customer Specs

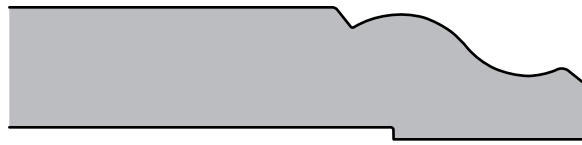

SWD 2114 | $\frac{5}{8}$ " x Customer Specs



SWD 2115 | $\frac{7}{16}$ " x Customer Specs



SWD 2116 | $1\frac{1}{16}$ " x Customer Specs



SWD 2117 | $\frac{3}{4}$ " x Customer Specs



SWD 2118 | $\frac{5}{8}$ " x Customer Specs

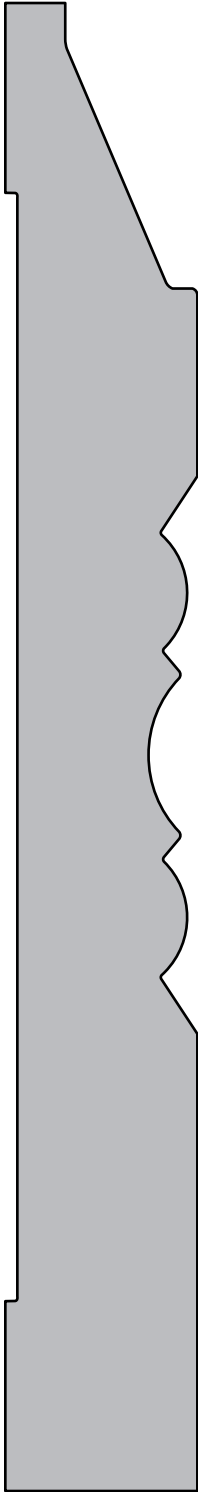

SWD 2112 | 1 " x $7\frac{3}{4}$ "



SWD 2119 | $\frac{3}{4}$ " x Customer Specs



SWD 2120 | $\frac{5}{8}$ " x Customer Specs



SWD 2121 | $1\frac{1}{16}$ " x Customer Specs

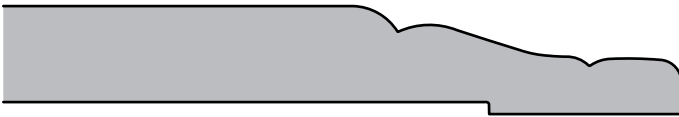

SWD 2122 | $\frac{9}{16}$ " x Customer Specs

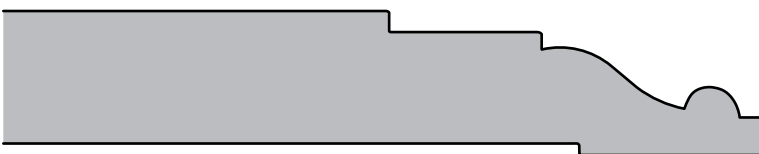

SWD 2123 | $\frac{3}{4}$ " x Customer Specs

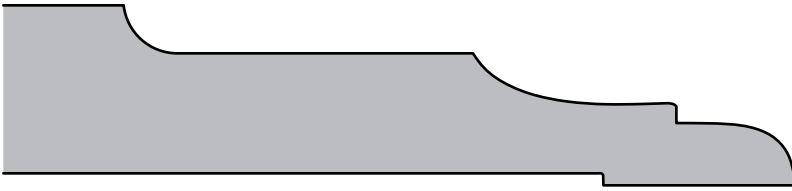

SWD 2124 | $1\frac{5}{16}$ " x Customer Specs

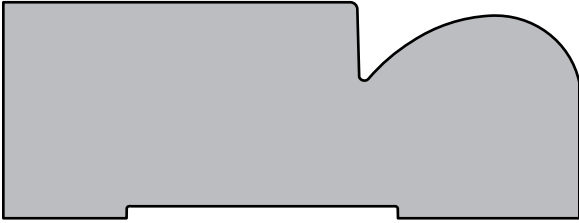

SWD 2125 | $1\frac{1}{8}$ " x 3"

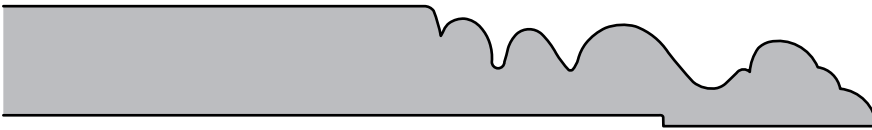

SWD 2126 | $\frac{5}{8}$ " x Customer Specs

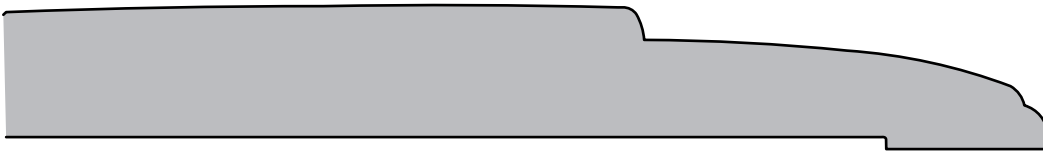

SWD 2127 | $\frac{3}{4}$ " x Customer Specs



SWD 2128 | $\frac{9}{16}$ " x Customer Specs



SWD 2129 | $\frac{3}{4}$ " x Customer Specs



SWD 2130 | $\frac{3}{4}$ " x Customer Specs

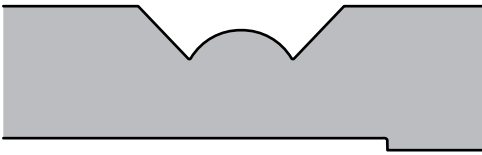

SWD 2131 | $\frac{3}{4}$ " x Customer Specs



SWD 2132 | $1\frac{1}{16}$ " x Customer Specs

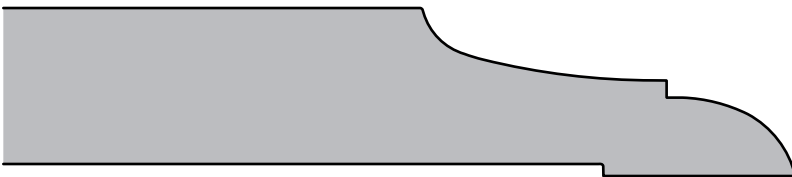

SWD 2133 | $\frac{7}{8}$ " x Customer Specs



SWD 2134 | $\frac{3}{4}$ " x Customer Specs



SWD 2135 | $1\frac{1}{16}$ " x Customer Specs

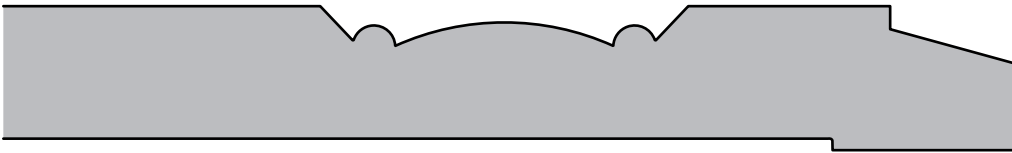

SWD 2136 | $\frac{3}{4}$ " x $5\frac{1}{2}$ "



SWD 2137 | $\frac{3}{4}$ " x Customer Specs



SWD 2138 | $1\frac{1}{16}$ " x Customer Specs

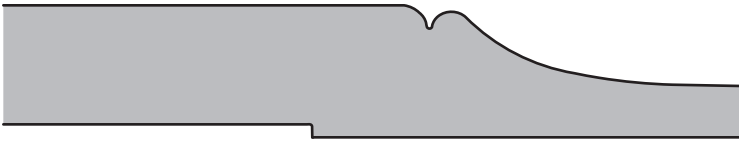

SWD 2139 | $1\frac{1}{16}$ " x Customer Specs



SWD 2140 | $1\frac{3}{16}$ " x Customer Specs



SWD 2141 | $1\frac{1}{16}$ " x Customer Specs



SWD 2142 | $\frac{3}{4}$ " x Customer Specs

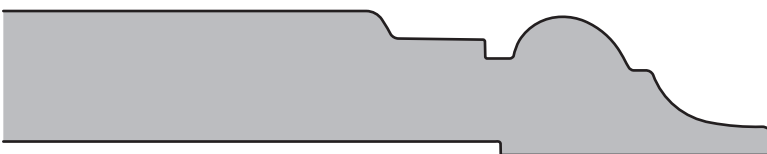

SWD 2143 | $\frac{3}{4}$ " x Customer Specs



SWD 2144 | $\frac{3}{4}$ " x Customer Specs



SWD 2145 | $\frac{15}{16}$ " x Customer Specs

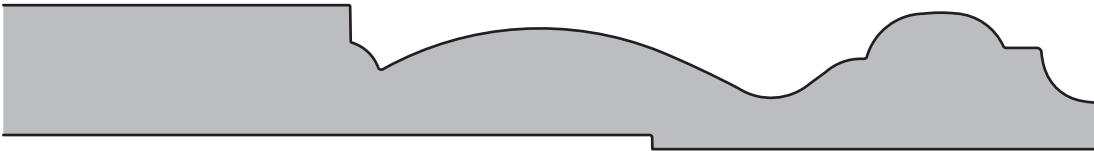

SWD 2146 | $\frac{3}{4}$ " x Customer Specs



SWD 2147 | $\frac{3}{4}$ " x Customer Specs



SWD 2148 | $\frac{3}{4}$ " x Customer Specs

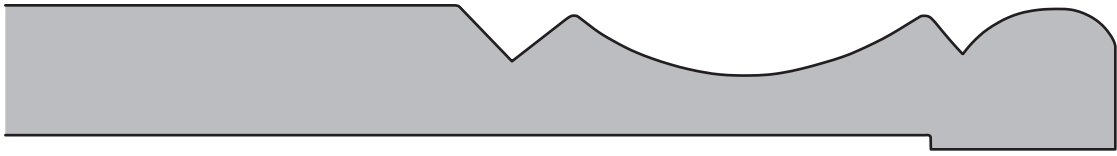

SWD 2149 | $\frac{3}{4}$ " x Customer Specs

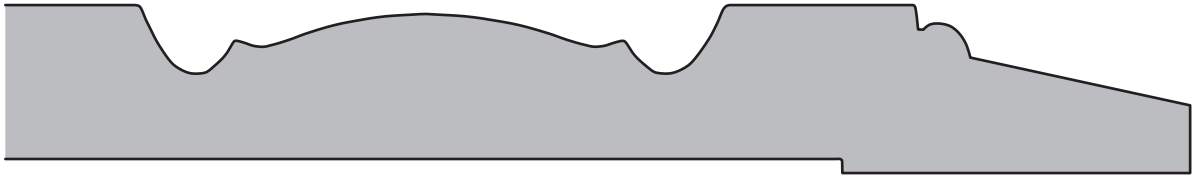

SWD 2150 | $\frac{7}{8}$ " x Customer Specs

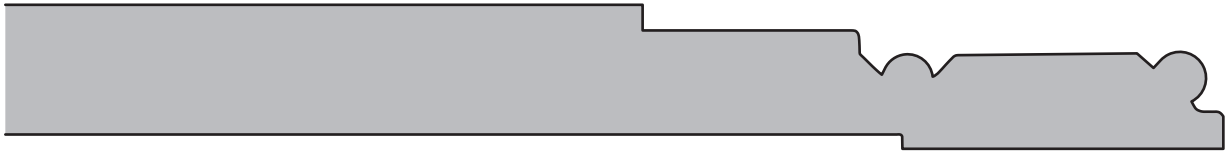

SWD 2151 | $\frac{3}{4}$ " x Customer Specs



SWD 2152 | $\frac{7}{8}$ " x Customer Specs



SWD 2153 | $\frac{1}{2}$ " x Customer Specs



SWD 2154 | $\frac{1}{16}$ " x Customer Specs



SWD 2155 | $\frac{3}{4}$ " x Customer Specs



SWD 2156 | $\frac{3}{4}$ " x Customer Specs



SWD 2157 | $\frac{5}{8}$ " x Customer Specs



SWD 2158 | $1\frac{1}{16}$ " x Customer Specs



SWD 2159 | $\frac{5}{8}$ " x Customer Specs



SWD 2160 | $\frac{3}{4}$ " x Customer Specs

SECTION 3

Chair Rail, Bed,
& Panel Moulding Profiles

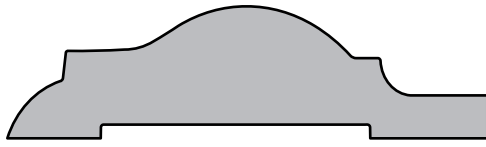

SWD 300 | $1\frac{1}{16}'' \times 2\frac{1}{2}''$

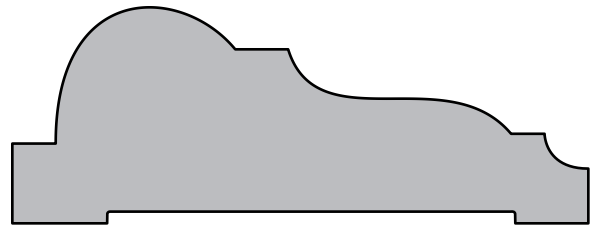

SWD 301 | $1\frac{1}{8}'' \times 3''$



SWD 302 | $\frac{5}{16}'' \times \frac{3}{4}''$

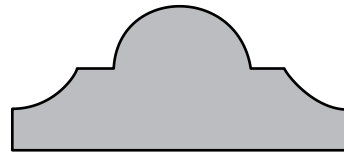

SWD 303 | $\frac{3}{4}'' \times 1\frac{3}{4}''$

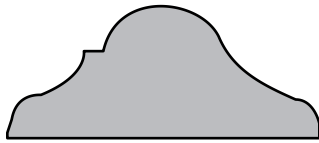

SWD 304 | $1\frac{1}{16}'' \times 1\frac{5}{8}''$



SWD 305 | $\frac{1}{2}'' \times 1\frac{5}{16}''$

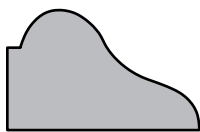

SWD 306 | $\frac{5}{8}'' \times 1''$

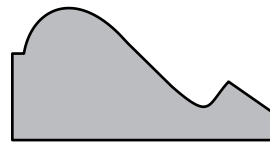

SWD 307 | $1\frac{1}{16}'' \times 1\frac{3}{8}''$

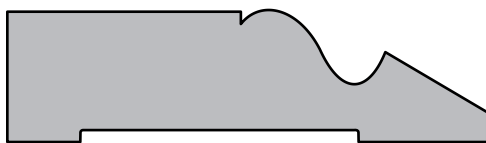

SWD 308 | $1\frac{1}{16}'' \times 2\frac{1}{2}''$

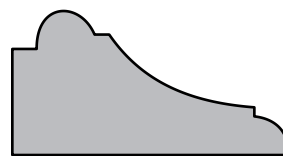

SWD 309 | $\frac{3}{4}'' \times 1\frac{7}{16}''$

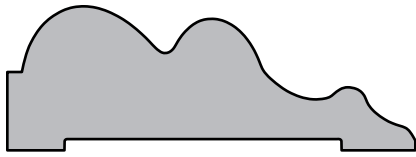

SWD 310 | $\frac{3}{4}'' \times 2\frac{1}{8}''$

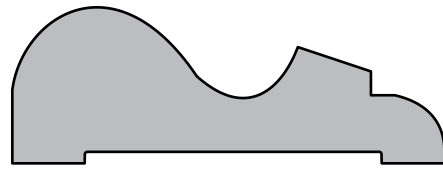

SWD 311 | $1\frac{3}{16}'' \times 2\frac{1}{4}''$

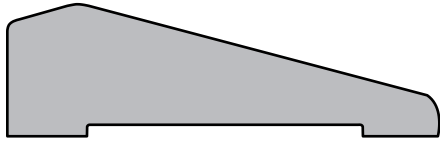

SWD 312 | $1\frac{1}{16}'' \times 2\frac{1}{4}''$

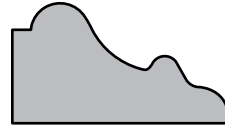

SWD 313 | $\frac{5}{8}'' \times 1\frac{1}{8}''$

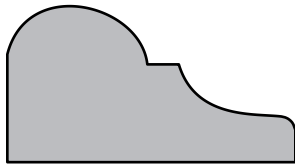

SWD 314 | $1\frac{3}{16}'' \times 1\frac{1}{2}''$

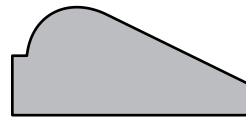

SWD 315 | $\frac{9}{16}'' \times 1\frac{1}{4}''$

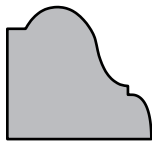

SWD 316 | $1\frac{1}{16}'' \times \frac{3}{4}''$



SWD 317 | $1'' \times 2\frac{3}{4}''$

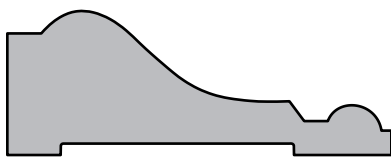

SWD 318 | $\frac{3}{4}'' \times 2''$

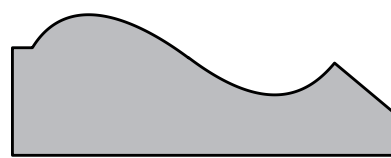

SWD 319 | $1\frac{1}{16}'' \times 1\frac{7}{8}''$

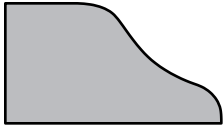

SWD 320 | $\frac{5}{8}'' \times 1\frac{1}{8}''$

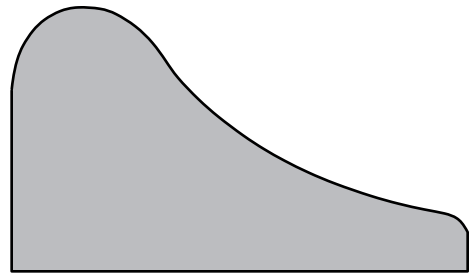

SWD 321 | $1\frac{3}{8}'' \times 2\frac{3}{8}''$

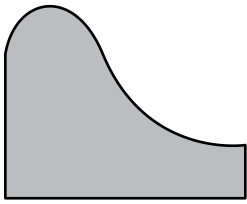

SWD 322 | $1'' \times 1\frac{1}{4}''$

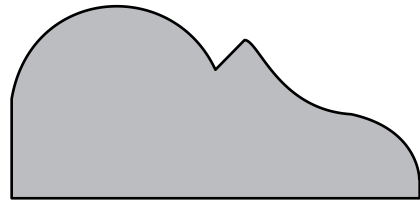

SWD 323 | $1'' \times 2\frac{1}{8}''$

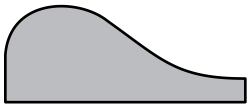

SWD 324 | $\frac{1}{2}'' \times 1\frac{1}{4}''$



SWD 325 | $\frac{1}{16}'' \times 1''$



SWD 326 | $\frac{1}{2}'' \times \frac{3}{4}''$

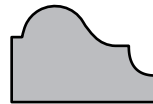

SWD 327 | $\frac{1}{2}'' \times \frac{3}{4}''$

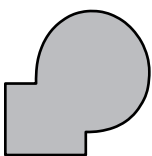

SWD 328 | $\frac{3}{4}'' \times \frac{3}{4}''$

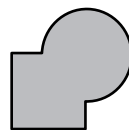

SWD 329 | $\frac{5}{8}'' \times \frac{5}{8}''$

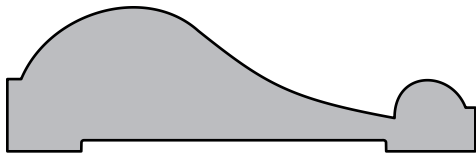

SWD 330 | $\frac{3}{4}'' \times 2\frac{7}{16}''$

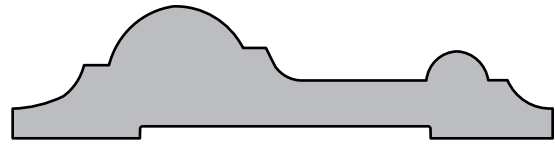

SWD 331 | $1\frac{1}{16}'' \times 2\frac{13}{16}''$

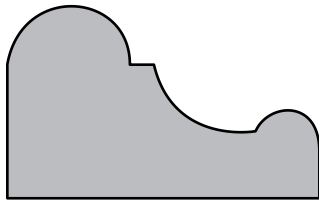

SWD 332 | $1'' \times 1\frac{5}{8}''$

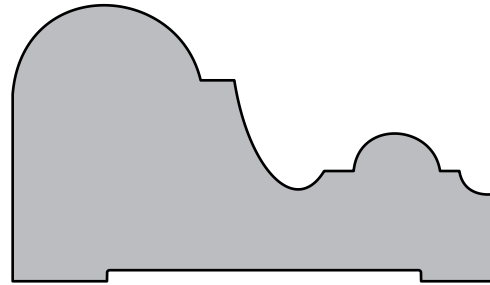

SWD 333 | $1\frac{7}{16}'' \times 2\frac{1}{2}''$

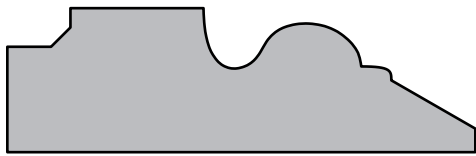

SWD 334 | $\frac{3}{4}'' \times 2\frac{7}{16}''$

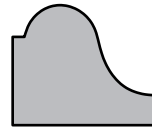

SWD 335 | $\frac{5}{8}'' \times \frac{3}{4}''$

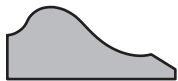

SWD 336 | $\frac{3}{8}'' \times \frac{7}{8}''$

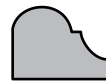

SWD 337 | $\frac{3}{8}'' \times \frac{1}{2}''$

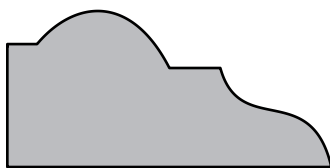

SWD 338 | $1\frac{3}{16}'' \times 1\frac{11}{16}''$



SWD 339 | $\frac{7}{16}'' \times \frac{1}{2}''$



SWD 340 | $\frac{3}{8}'' \times \frac{3}{8}''$

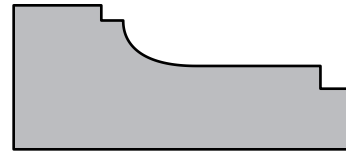

SWD 341 | $\frac{3}{4}'' \times 1\frac{3}{4}''$

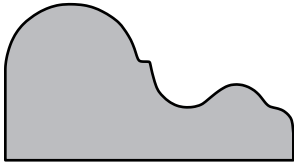

SWD 342 | $1\frac{3}{16}'' \times 1\frac{1}{2}''$

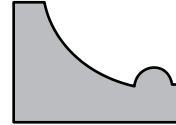

SWD 343 | $\frac{7}{8}'' \times \frac{5}{8}''$

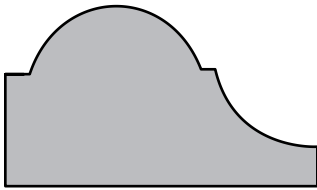

SWD 344 | $1\frac{5}{16}'' \times 1\frac{5}{8}''$



SWD 345 | $\frac{1}{2}'' \times 1\frac{7}{16}''$



SWD 346 | $\frac{5}{16}'' \times 1\frac{7}{16}''$

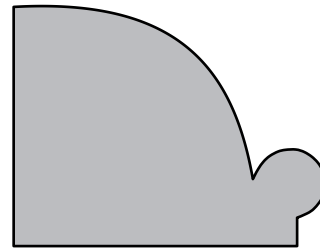

SWD 347 | $1\frac{1}{4}'' \times 1\frac{5}{8}''$

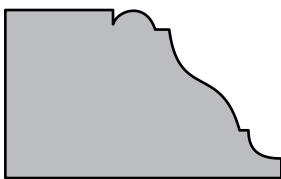

SWD 348 | $\frac{7}{8}'' \times 1\frac{7}{16}''$

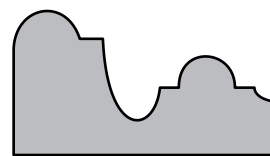

SWD 349 | $\frac{3}{4}'' \times 1\frac{3}{8}''$



SWD 350 | $\frac{3}{4}'' \times 1\frac{7}{16}''$



SWD 351 | $\frac{5}{8}'' \times 2''$

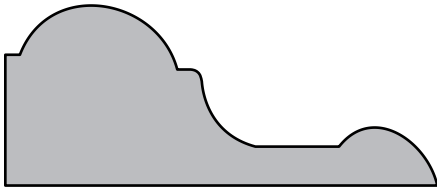

SWD 352 | $1\frac{5}{16}'' \times 2\frac{1}{4}''$



SWD 353 | $\frac{3}{4}'' \times 1\frac{5}{8}''$

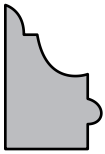

SWD 354 | $\frac{1}{2}'' \times \frac{3}{4}''$

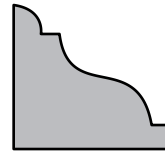

SWD 355 | $1\frac{3}{16}'' \times \frac{3}{4}''$

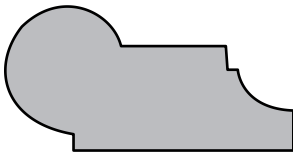

SWD 356 | $\frac{3}{4}'' \times 1\frac{1}{2}''$

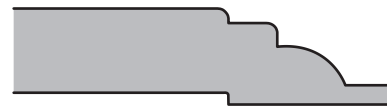

SWD 357 | $\frac{1}{2}'' \times$ Customer Specs

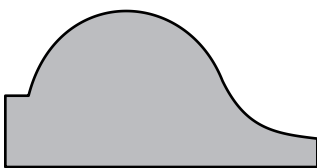

SWD 358 | $1\frac{3}{16}'' \times 1\frac{5}{8}''$

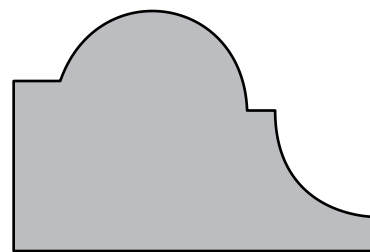

SWD 359 | $1\frac{1}{4}'' \times 1\frac{7}{8}''$

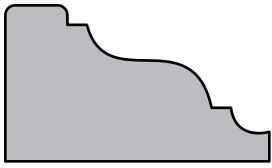

SWD 360 | $1\frac{3}{16}'' \times 1\frac{3}{8}''$

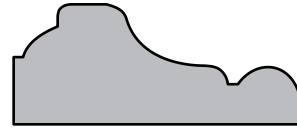

SWD 361 | $\frac{5}{8}'' \times 1\frac{1}{2}''$

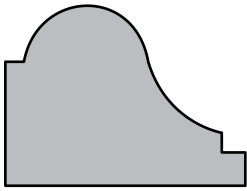

SWD 362 | $1\frac{5}{16}'' \times 1\frac{1}{4}''$

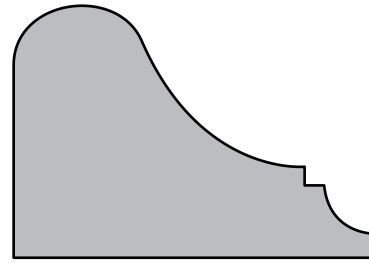

SWD 363 | $1\frac{5}{16}'' \times 1\frac{7}{8}''$



SWD 364 | $\frac{5}{16}'' \times \frac{5}{16}''$

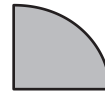

SWD 365 | $\frac{7}{16}'' \times \frac{1}{2}''$

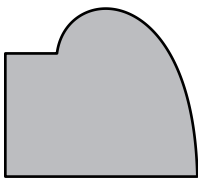

SWD 366 | $\frac{7}{8}'' \times 1''$

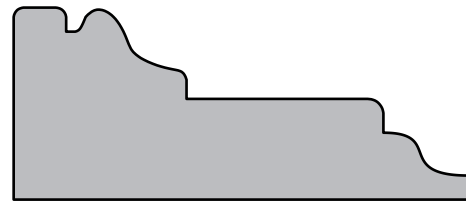

SWD 367 | $1'' \times 2\frac{3}{8}''$

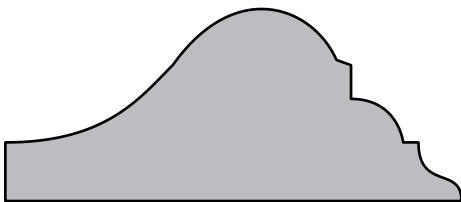

SWD 368 | $1'' \times 2\frac{3}{8}''$

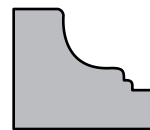

SWD 369 | $\frac{5}{8}'' \times \frac{3}{4}''$

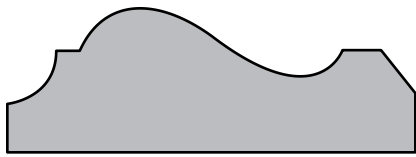

SWD 370 | $\frac{3}{4}'' \times 2\frac{1}{8}''$

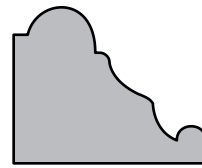

SWD 371 | $1\frac{3}{16}'' \times 1''$

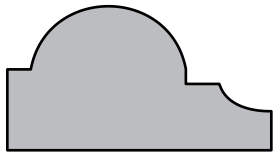

SWD 372 | $\frac{3}{4}'' \times 1\frac{3}{8}''$

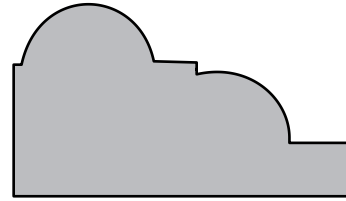

SWD 373 | $1'' \times 1\frac{3}{4}''$

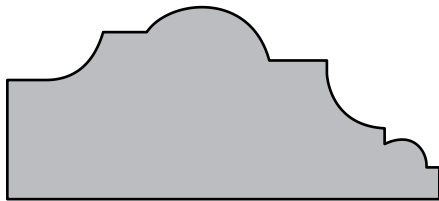

SWD 374 | $1'' \times 2\frac{1}{4}''$

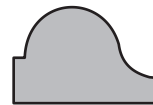

SWD 375 | $\frac{1}{2}'' \times \frac{3}{4}''$

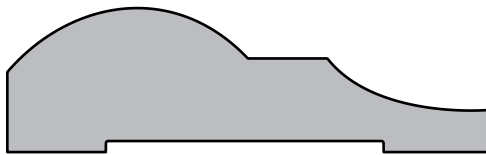

SWD 376 | $\frac{3}{4}'' \times 3''$

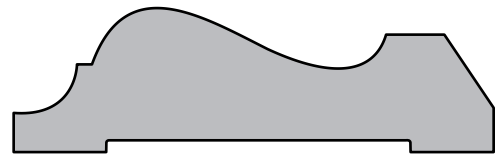

SWD 377 | $\frac{3}{4}'' \times 2\frac{1}{2}''$

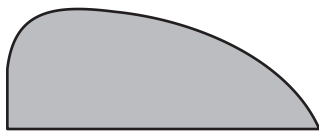

SWD 378 | $\frac{5}{8}'' \times 1\frac{5}{8}''$

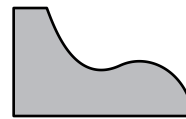

SWD 379 | $\frac{9}{16}'' \times 1\frac{15}{16}''$

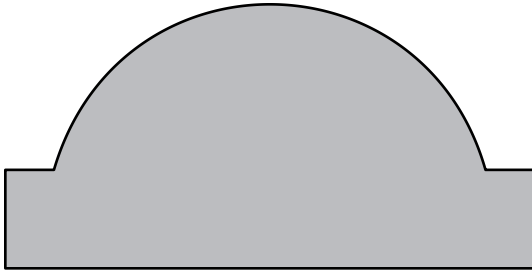

SWD 380 | $1\frac{3}{8}'' \times 2\frac{3}{4}''$

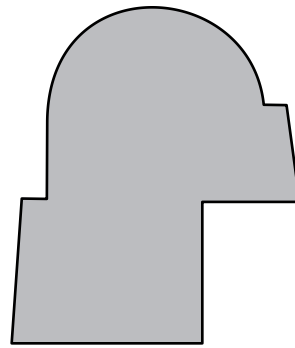

SWD 381 | $1\frac{1}{2}'' \times 1\frac{3}{4}''$

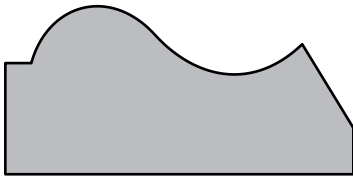

SWD 382 | $\frac{7}{8}'' \times 1\frac{13}{16}''$

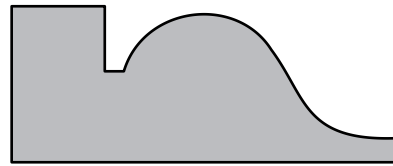

SWD 383 | $1\frac{3}{16}'' \times 2''$



SWD 384 | $\frac{5}{16}'' \times \frac{3}{4}''$

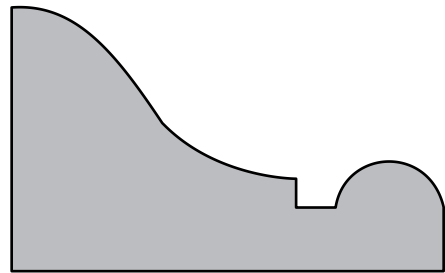

SWD 385 | $1\frac{3}{8}'' \times 2\frac{1}{4}''$

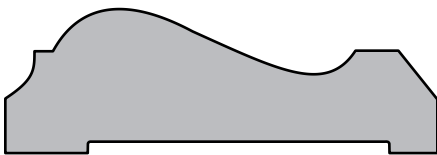

SWD 386 | $\frac{3}{4}'' \times 2\frac{1}{4}''$



SWD 387 | $\frac{7}{16}'' \times 1\frac{13}{16}''$

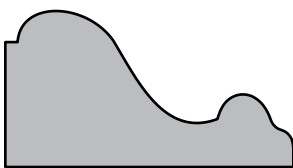

SWD 388 | $1\frac{3}{16}'' \times 1\frac{1}{2}''$

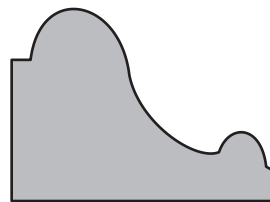

SWD 389 | $1'' \times 1\frac{3}{8}''$

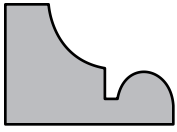

SWD 390 | $\frac{5}{8}'' \times \frac{7}{8}''$

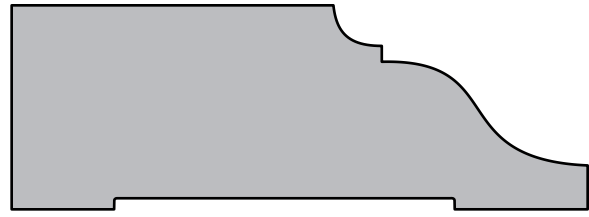

SWD 391 | $1\frac{1}{16}'' \times 3''$



SWD 392 | $\frac{3}{4}'' \times$ Customer Specs

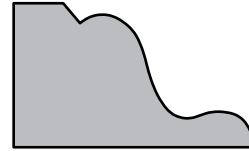

SWD 393 | $\frac{3}{4}'' \times 1\frac{1}{4}''$

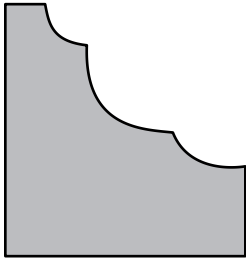

SWD 394 | $1\frac{5}{16}'' \times 1\frac{1}{4}''$

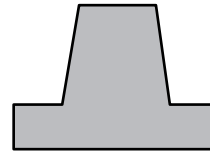

SWD 395 | $\frac{3}{4}'' \times 1\frac{1}{16}''$



SWD 396 | $\frac{3}{8}'' \times 1\frac{1}{16}''$



SWD 397 | $1'' \times 1\frac{7}{8}''$

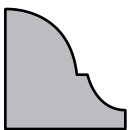

SWD 398 | $\frac{5}{8}'' \times \frac{5}{8}''$



SWD 399 | $\frac{5}{16}'' \times \frac{3}{4}''$

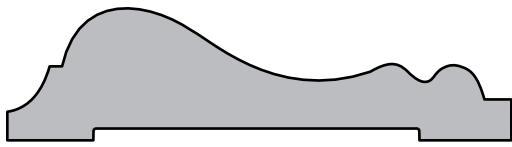

SWD 3000 | $1\frac{1}{16}'' \times 2\frac{5}{8}''$

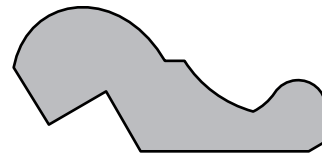

SWD 3001 | $\frac{3}{4}'' \times 1\frac{5}{8}''$

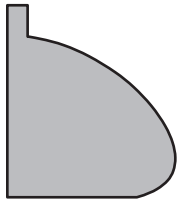

SWD 3002 | $\frac{7}{8}'' \times 1''$

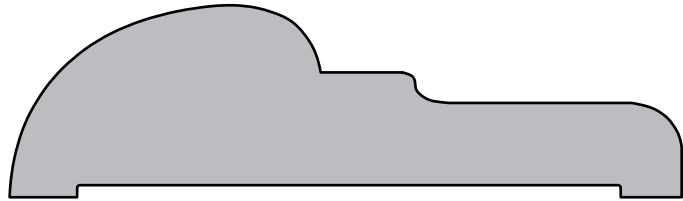

SWD 3003 | $1'' \times 3\frac{1}{2}''$

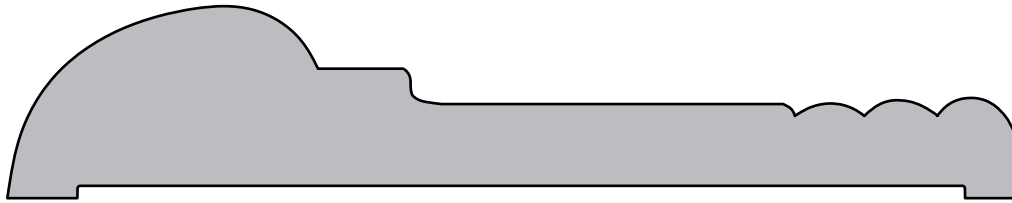

SWD 3004 | $1'' \times 5\frac{1}{4}''$



SWD 3005 | $\frac{3}{4}'' \times 1\frac{1}{2}''$

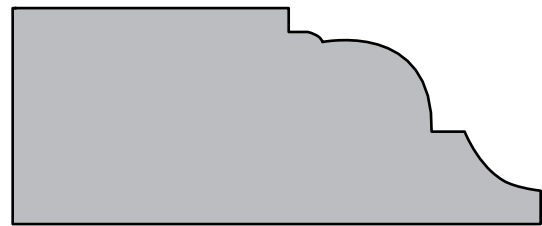

SWD 3006 | $1\frac{1}{8}'' \times 2\frac{3}{4}''$



SWD 3007 | $1\frac{3}{16}'' \times 4''$

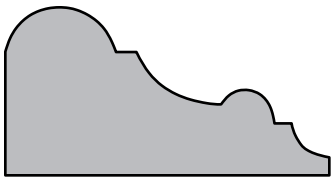

SWD 3008 | $\frac{7}{8}'' \times 1\frac{11}{16}''$



SWD 3009 | $\frac{5}{8}'' \times 1\frac{1}{4}''$

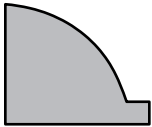

SWD 3010 | $\frac{5}{8}'' \times \frac{3}{4}''$

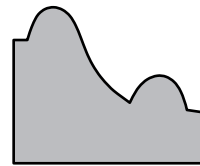

SWD 3011 | $1\frac{3}{16}'' \times 1''$

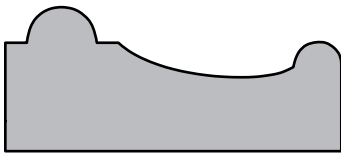

SWD 3012 | $\frac{3}{4}'' \times 1\frac{3}{4}''$

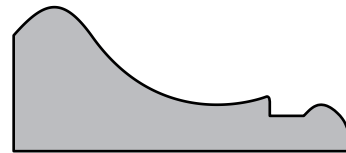

SWD 3013 | $\frac{3}{4}'' \times 1\frac{3}{4}''$

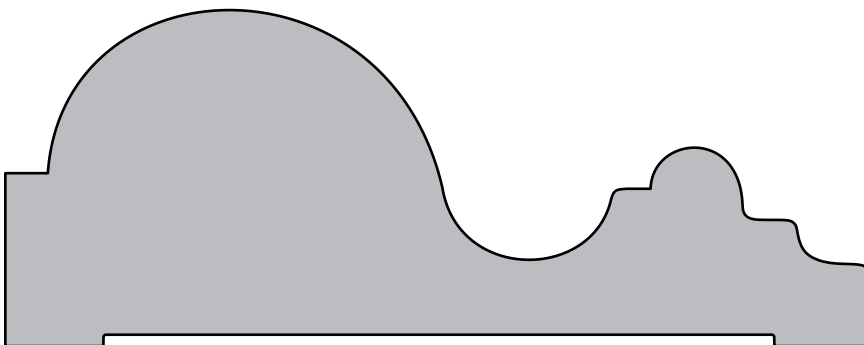

SWD 3014 | $1\frac{3}{4}'' \times 4\frac{1}{2}''$

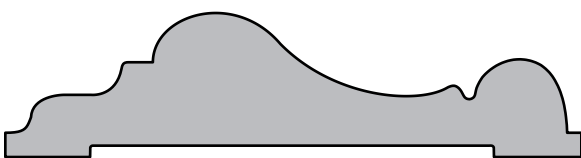

SWD 3015 | $\frac{3}{4}'' \times 3''$



SWD 3016 | $\frac{3}{4}'' \times 2''$

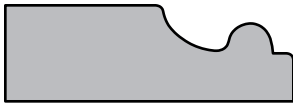

SWD 3017 | $\frac{1}{2}$ " x $1\frac{1}{2}$ "

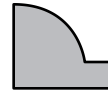

SWD 3018 | $\frac{7}{16}$ " x $\frac{1}{2}$ "

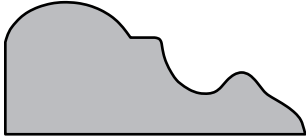

SWD 3019 | $1\frac{1}{16}$ " x $1\frac{9}{16}$ "

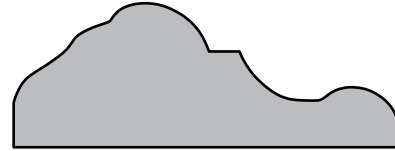

SWD 3020 | $\frac{3}{4}$ " x 2"

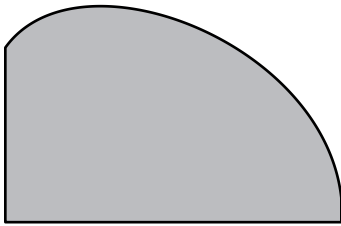

SWD 3021 | $1\frac{1}{8}$ " x $1\frac{3}{4}$ "

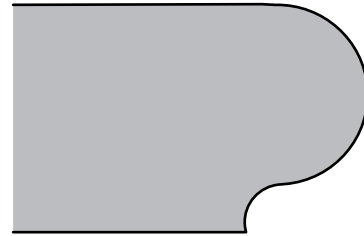

SWD 3022 | $1\frac{3}{16}$ " x Customer Specs

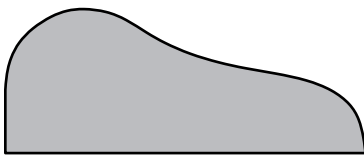

SWD 3023 | $\frac{3}{4}$ " x $1\frac{7}{8}$ "

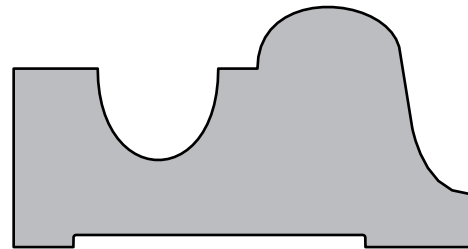

SWD 3024 | $1\frac{1}{4}$ " x $2\frac{3}{8}$ "

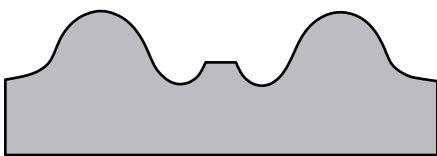

SWD 3025 | $\frac{3}{4}$ " x $2\frac{1}{4}$ "

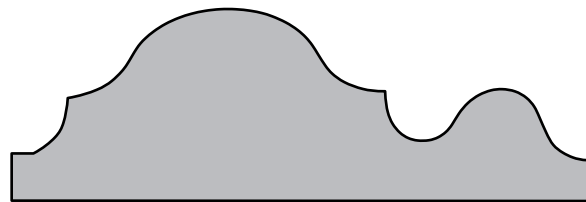

SWD 3026 | 1" x 3"

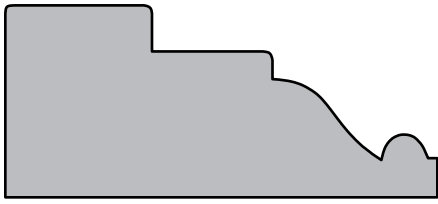

SWD 3027 | 1" x 2¼"

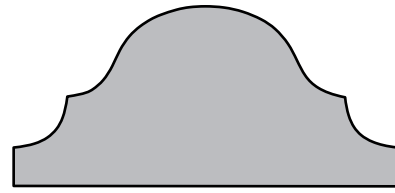

SWD 3028 | 1½" x 2"

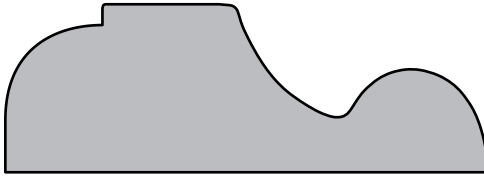

SWD 3029 | 7⁄8" x 2½"

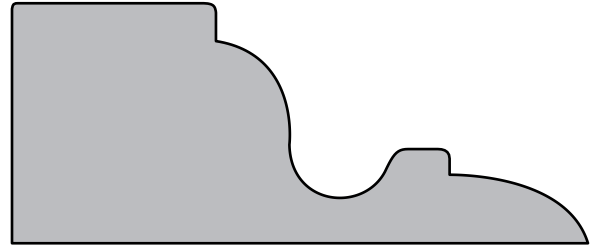

SWD 3030 | 1¼" x 3"



SWD 3031 | 3⁄8" x 7⁄8"



SWD 3032 | 15⁄32" x 15⁄32"



SWD 3033 | 5⁄8" x 2¾"

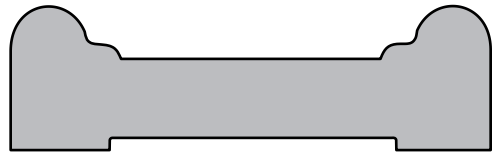

SWD 3034 | ¾" x 2½"

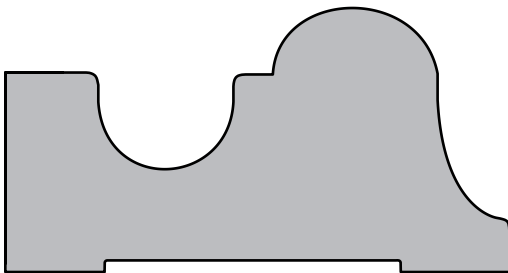

SWD 3035 | 1¾" x 2⅝"

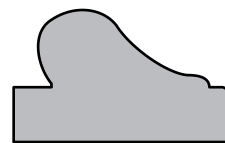

SWD 3036 | 1¼" x 1⅛"

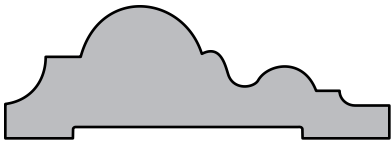

SWD 3037 | $1\frac{1}{16}'' \times 2''$

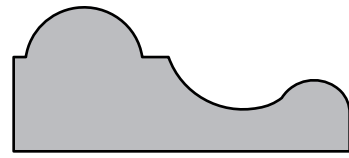

SWD 3038 | $\frac{3}{4}'' \times 1\frac{3}{4}''$

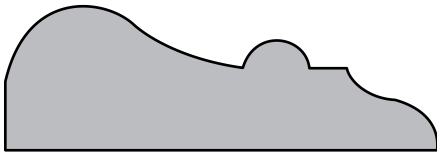

SWD 3039 | $\frac{3}{4}'' \times 2\frac{1}{4}''$

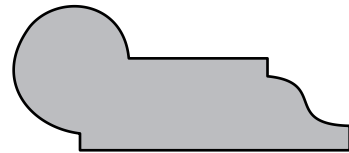

SWD 3040 | $\frac{3}{4}'' \times 1\frac{3}{4}''$

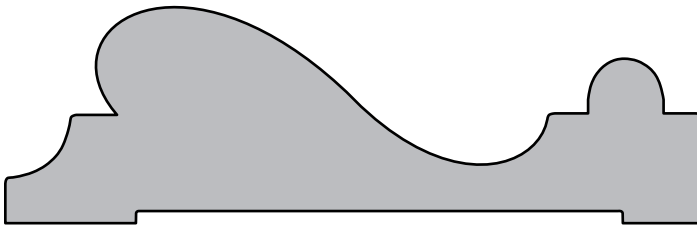

SWD 3041 | $1\frac{1}{8}'' \times 3\frac{5}{8}''$

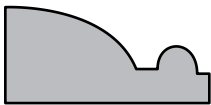

SWD 3042 | $\frac{1}{2}'' \times 1\frac{1}{16}''$

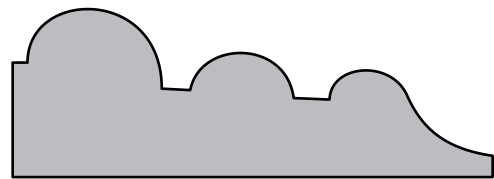

SWD 3043 | $\frac{7}{8}'' \times 2\frac{1}{2}''$

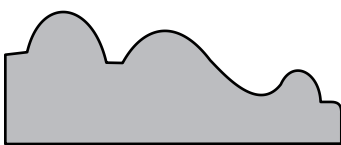

SWD 3044 | $1\frac{1}{16}'' \times 1\frac{3}{4}''$

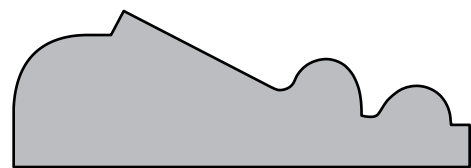

SWD 3045 | $1\frac{3}{16}'' \times 2\frac{3}{8}''$

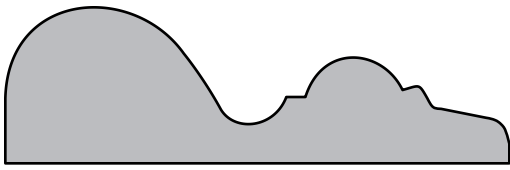

SWD 3046 | $1\frac{3}{16}'' \times 2\frac{5}{8}''$

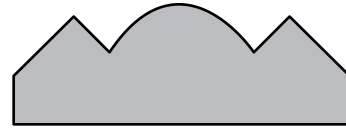

SWD 3047 | $\frac{5}{8}'' \times 1\frac{3}{4}''$

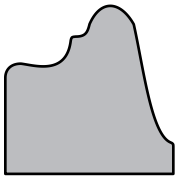

SWD 3048 | $\frac{7}{8}'' \times \frac{7}{8}''$

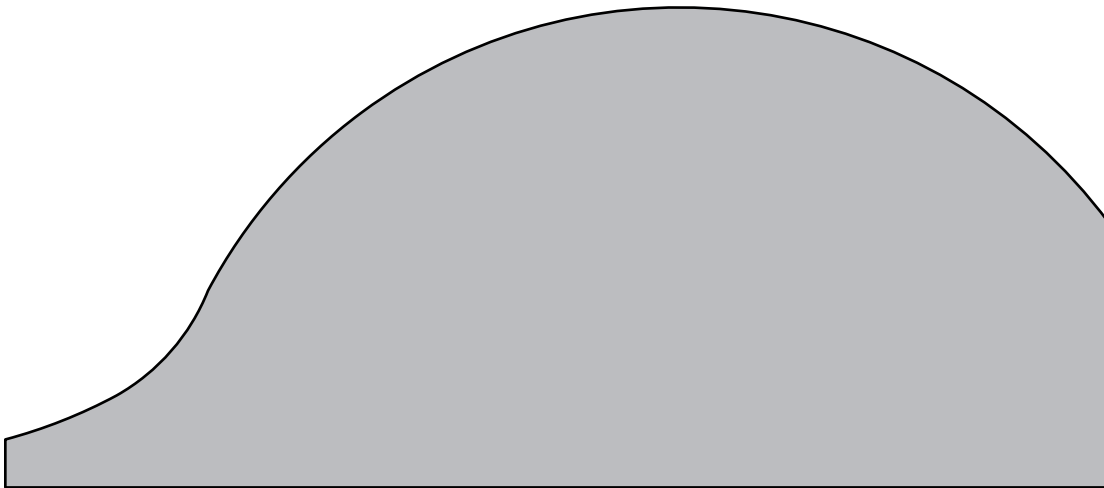

SWD 3049 | $2\frac{1}{2}'' \times 5\frac{3}{4}''$

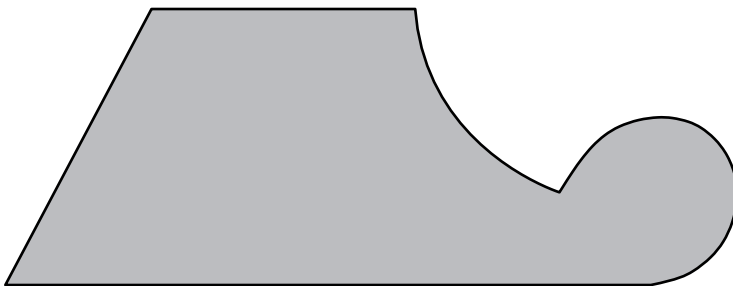

SWD 3050 | $1\frac{7}{16}'' \times 3\frac{13}{16}''$

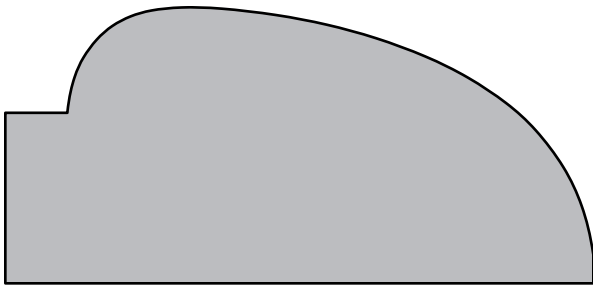

SWD 3051 | $1\frac{7}{16}'' \times 3\frac{1}{16}''$

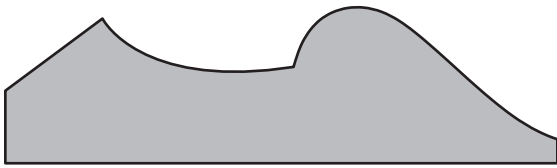

SWD 3052 | $1\frac{3}{16}'' \times 2\frac{7}{8}''$

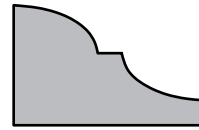

SWD 3053 | $\frac{5}{8}'' \times 1''$

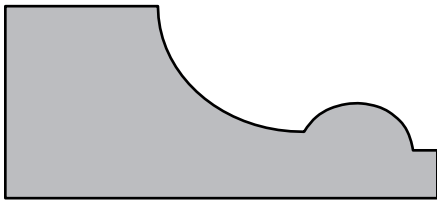

SWD 3054 | $1'' \times 2\frac{1}{4}''$



SWD 3055 | $\frac{5}{8}'' \times 1\frac{1}{16}''$



SWD 3056 | $\frac{3}{4}'' \times 3\frac{1}{2}''$

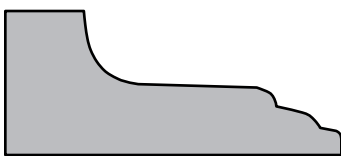

SWD 3057 | $\frac{3}{4}'' \times 1\frac{3}{4}''$



SWD 3058 | $\frac{5}{8}'' \times 1\frac{7}{8}''$

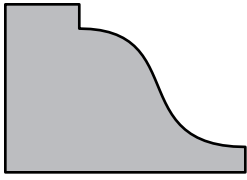

SWD 3059 | $\frac{7}{8}'' \times 1\frac{1}{4}''$



SWD 3060 | $1\frac{1}{4}'' \times 2\frac{1}{2}''$

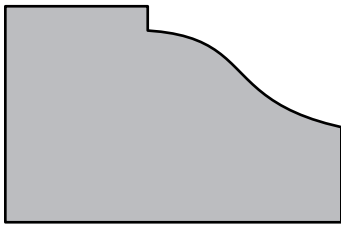

SWD 3061 | $1\frac{1}{8}'' \times 1\frac{3}{4}''$

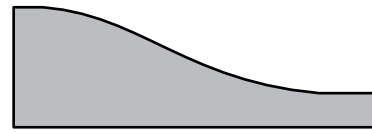

SWD 3062 | $\frac{1}{2}'' \times 1''$



SWD 3063 | $\frac{7}{16}'' \times \frac{1}{2}''$



SWD 3064 | $\frac{1}{4}'' \times \frac{3}{8}''$

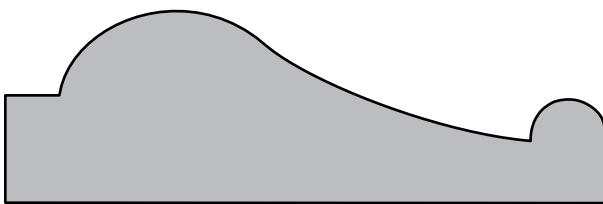

SWD 3065 | $1'' \times 2\frac{15}{16}''$

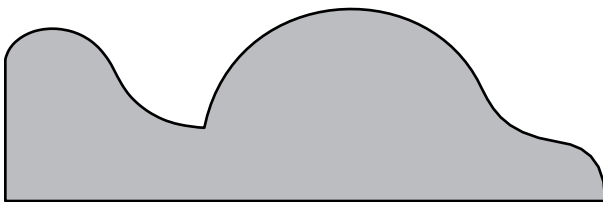

SWD 3066 | $1'' \times 3\frac{1}{8}''$

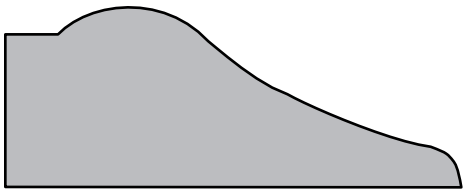

SWD 3067 | $1\frac{5}{16}'' \times 2\frac{3}{8}''$

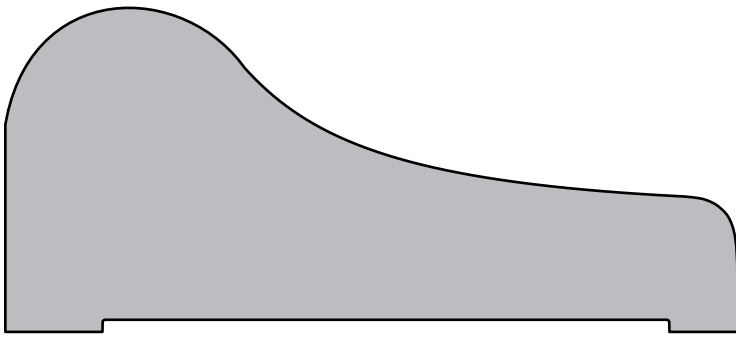

SWD 3068 | $1\frac{1}{16}'' \times 3\frac{13}{16}''$

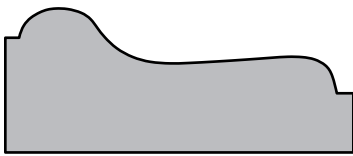

SWD 3069 | $\frac{3}{4}'' \times 1\frac{13}{16}''$

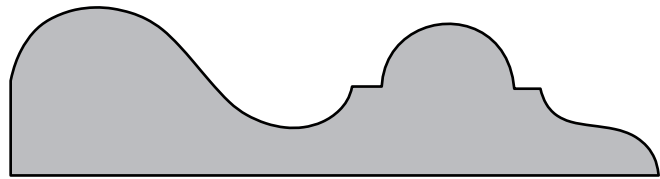

SWD 3070 | $\frac{7}{8}'' \times 3\frac{3}{8}''$

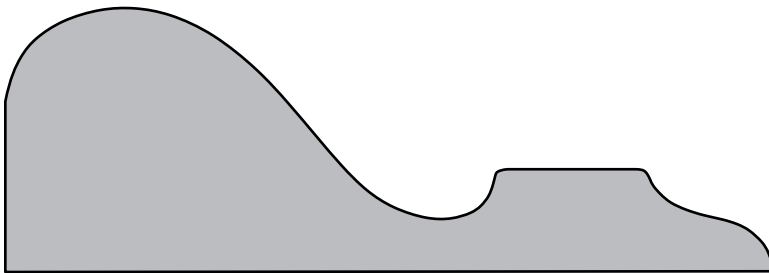

SWD 3071 | $1\frac{3}{8}'' \times 4''$

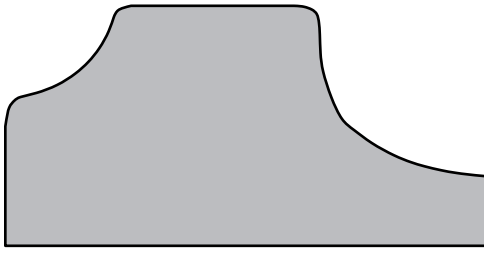

SWD 3072 | $1\frac{1}{4}'' \times 2\frac{1}{2}''$

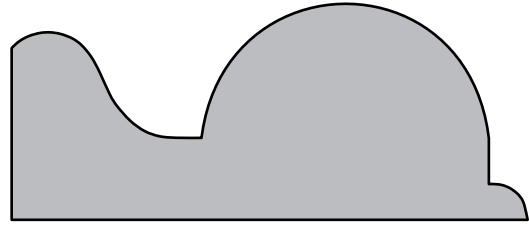

SWD 3073 | $1\frac{1}{8}'' \times 2\frac{1}{16}''$

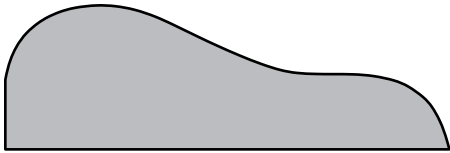

SWD 3074 | $\frac{3}{4}'' \times 2\frac{5}{16}''$

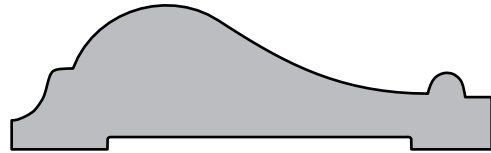

SWD 3075 | $\frac{3}{4}'' \times 2\frac{1}{2}''$

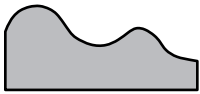

SWD 3076 | $\frac{7}{16}'' \times 1''$

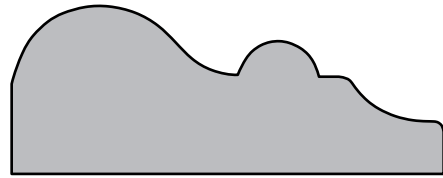

SWD 3077 | $\frac{7}{8}'' \times 2\frac{1}{4}''$

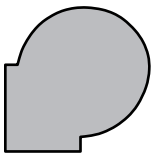

SWD 3078 | $\frac{3}{4}'' \times \frac{3}{4}''$

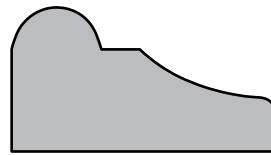

SWD 3079 | $\frac{3}{4}'' \times 1\frac{3}{8}''$

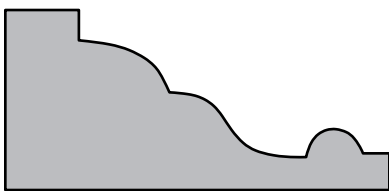

SWD 3080 | $1\frac{5}{16}'' \times 2''$

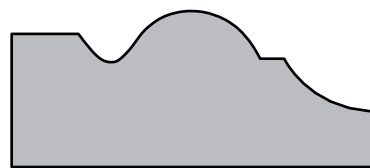

SWD 3081 | $1\frac{3}{16}'' \times 1\frac{7}{8}''$

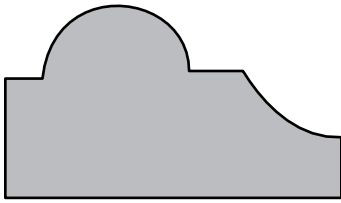

SWD 3082 | 1" x 1³/₄"



SWD 3083 | 3/4" x 1³/₄"

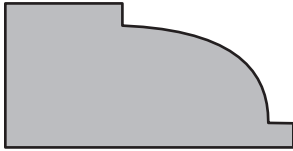

SWD 3084 | 3/4" x 1¹/₂"



SWD 3085 | 3/8" x 3/8"

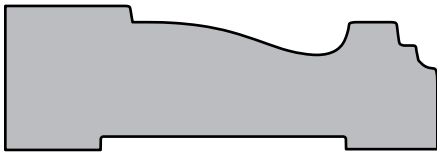

SWD 3086 | 3/4" x 2¹/₄"



SWD 3087 | 7/16" x 5/8"

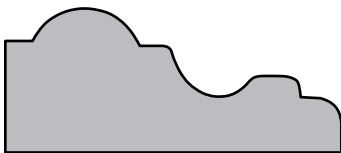

SWD 3088 | 3/4" x 1³/₄"

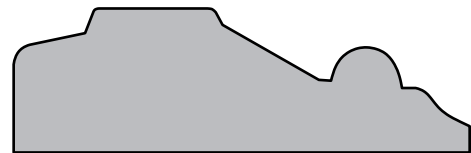

SWD 3089 | 3/4" x 2³/₈"

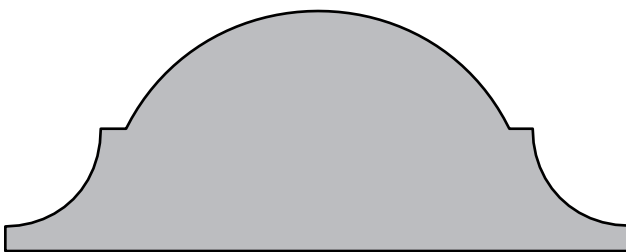

SWD 3090 | 1¹/₄" x 3¹/₄"

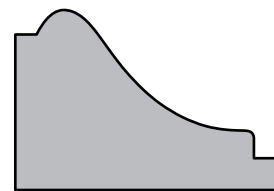

SWD 3091 | 1⁵/₁₆" x 1³/₈"

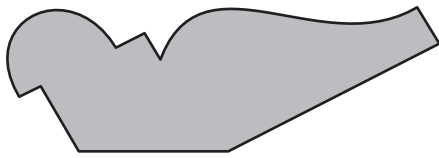

SWD 3092 | $\frac{3}{4}'' \times 2\frac{1}{4}''$

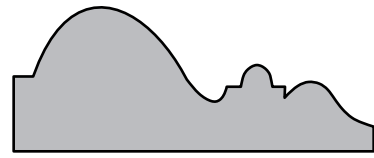

SWD 3093 | $\frac{3}{4}'' \times 1\frac{7}{8}''$

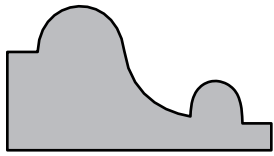

SWD 3094 | $\frac{3}{4}'' \times 1\frac{3}{8}''$

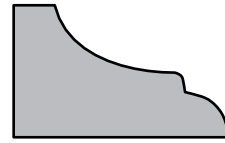

SWD 3095 | $1\frac{1}{16}'' \times 1\frac{1}{8}''$



SWD 3096 | $\frac{5}{8}'' \times 1\frac{3}{4}''$



SWD 3097 | $1\frac{1}{8}'' \times 3\frac{1}{2}''$

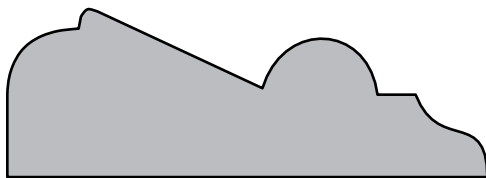

SWD 3098 | $\frac{7}{8}'' \times 2\frac{1}{2}''$

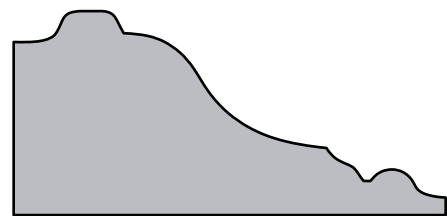

SWD 3099 | $1\frac{1}{16}'' \times 2\frac{1}{4}''$



SWD 3100 | $1\frac{3}{16}'' \times 2\frac{9}{16}''$

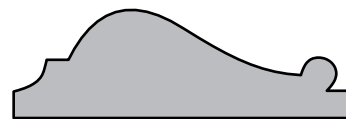

SWD 3101 | $\frac{9}{16}'' \times 1\frac{3}{4}''$

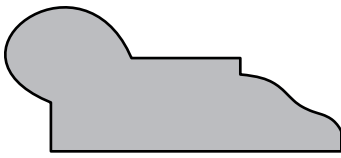

SWD 3102 | $\frac{3}{4}'' \times 1\frac{3}{4}''$

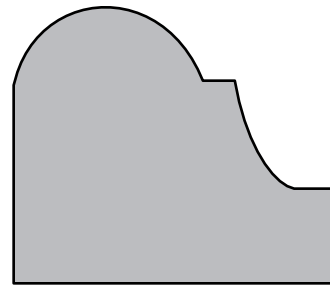

SWD 3103 | $1\frac{7}{16}'' \times 1\frac{11}{16}''$

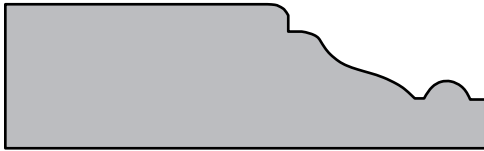

SWD 3104 | $\frac{3}{4}'' \times 2\frac{1}{2}''$

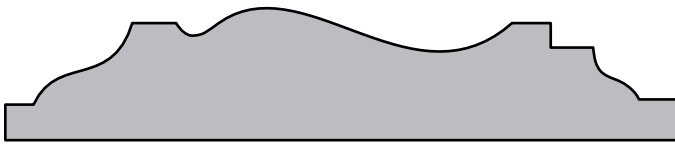

SWD 3105 | $1\frac{1}{16}'' \times 3\frac{1}{2}''$

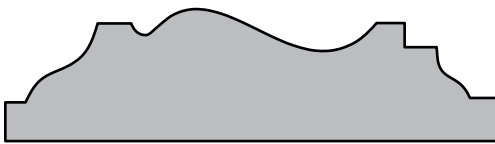

SWD 3106 | $1\frac{1}{16}'' \times 2\frac{9}{16}''$



SWD 3107 | $\frac{3}{4}'' \times 2\frac{3}{8}''$



SWD 3108 | $1\frac{3}{16}'' \times 1\frac{9}{16}''$

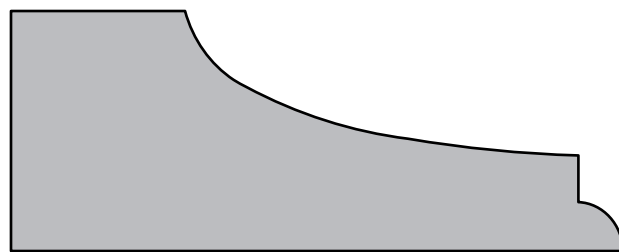

SWD 3109 | $1\frac{1}{4}'' \times 3\frac{1}{2}''$

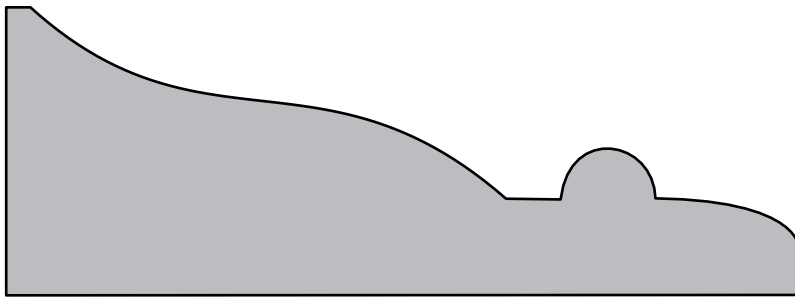

SWD 3110 | $1\frac{1}{2}'' \times 4\frac{1}{8}''$

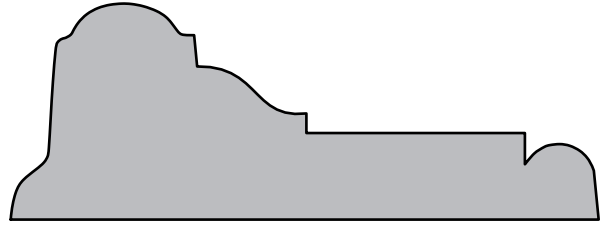

SWD 3111 | $1\frac{1}{8}'' \times 3\frac{1}{16}''$

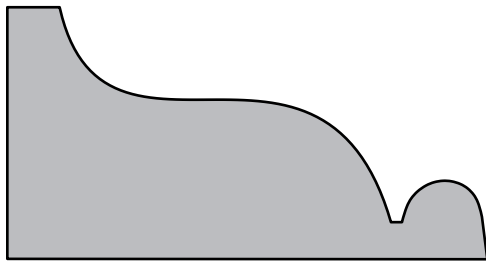

SWD 3112 | $1\frac{5}{16}'' \times 2\frac{1}{2}''$

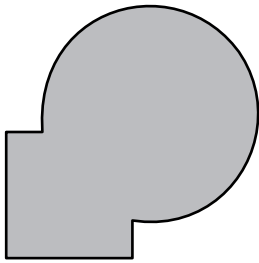

SWD 3113 | $1\frac{5}{16}'' \times 1\frac{5}{16}''$

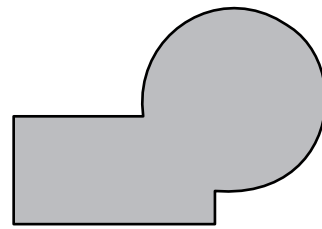

SWD 3114 | $1\frac{1}{8}'' \times 1\frac{5}{8}''$

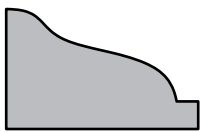

SWD 3115 | $\frac{5}{8}'' \times 1''$



SWD 3116 | $\frac{7}{16}'' \times 1\frac{3}{8}''$



SWD 3117 | $\frac{1}{2}'' \times \frac{1}{2}''$

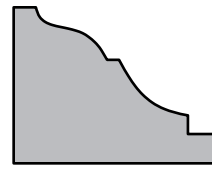

SWD 3118 | $1\frac{3}{16}'' \times 1\frac{1}{16}''$

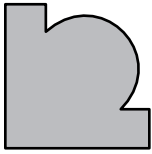

SWD 3119 | $\frac{3}{4}'' \times \frac{3}{4}''$



SWD 3120 | $\frac{3}{8}'' \times 1\frac{3}{16}''$



SWD 3121 | $\frac{3}{8}'' \times \frac{9}{16}''$

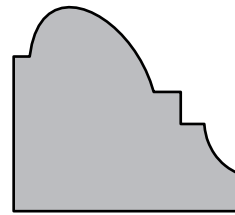

SWD 3122 | $1\frac{1}{16}'' \times 1\frac{3}{16}''$

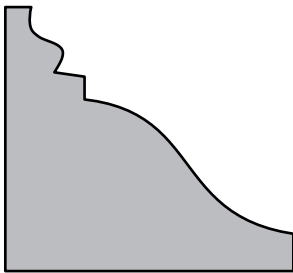

SWD 3123 | $1\frac{3}{8}'' \times 1\frac{1}{2}''$

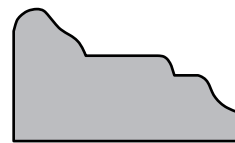

SWD 3124 | $1\frac{1}{16}'' \times 1\frac{3}{16}''$

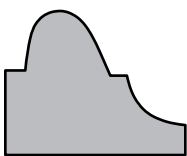

SWD 3125 | $\frac{3}{4}'' \times 1\frac{15}{16}''$

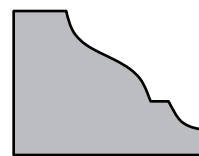

SWD 3126 | $\frac{3}{4}'' \times 1''$

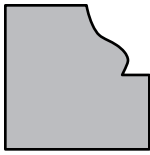

SWD 3127 | $\frac{3}{4}'' \times \frac{3}{4}''$

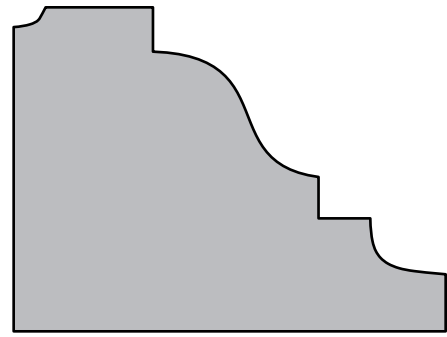

SWD 3128 | $1\frac{1}{16}'' \times 2\frac{1}{4}''$

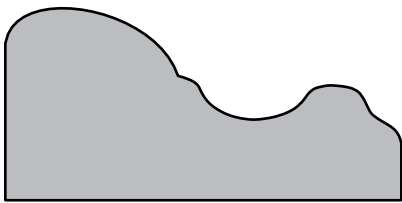

SWD 3129 | $1'' \times 2\frac{1}{16}''$

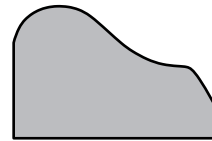

SWD 3130 | $1\frac{1}{16}'' \times 1\frac{1}{16}''$

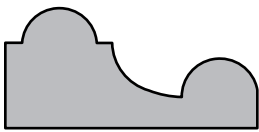

SWD 3131 | $\frac{5}{8}'' \times 1\frac{5}{16}''$

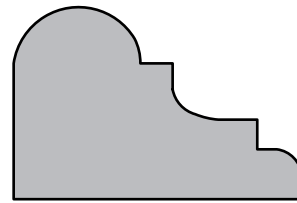

SWD 3132 | $1'' \times 1\frac{1}{2}''$



SWD 3133 | $\frac{1}{2}'' \times 1\frac{1}{8}''$

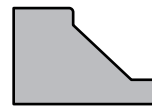

SWD 3134 | $\frac{1}{2}'' \times \frac{3}{4}''$



SWD 3135 | $\frac{3}{4}'' \times$ Customer Specs



SWD 3136 | $\frac{3}{4}$ " x 4"

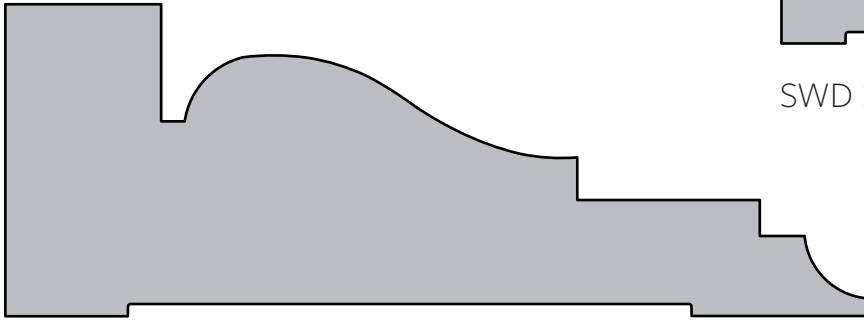

SWD 3138 | $1\frac{5}{8}$ " x $4\frac{1}{2}$ "

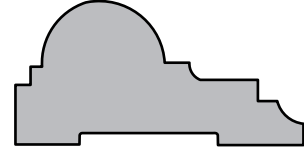

SWD 3137 | $\frac{3}{4}$ " x $1\frac{1}{2}$ "

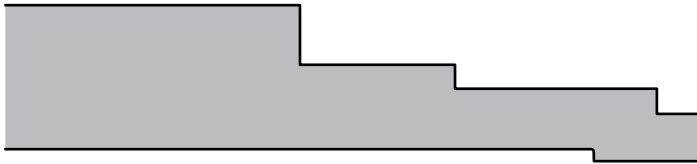

SWD 3139 | $\frac{13}{16}$ " x Customer Specs



SWD 3140 | $\frac{3}{4}$ " x Customer Specs

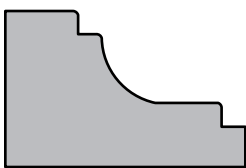

SWD 3141 | $\frac{13}{16}$ " x $1\frac{1}{4}$ "

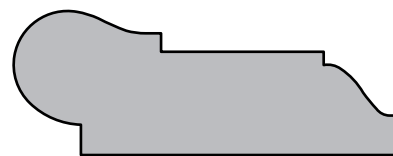

SWD 3142 | $\frac{3}{4}$ " x 2"

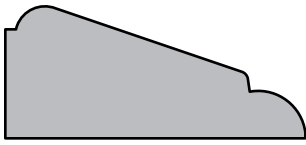

SWD 3143 | $1\frac{1}{16}'' \times 1\frac{9}{16}''$

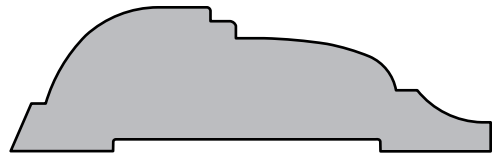

SWD 3144 | $\frac{3}{4}'' \times 2\frac{1}{2}''$

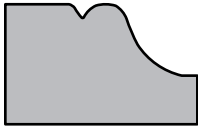

SWD 3145 | $\frac{5}{8}'' \times 1''$

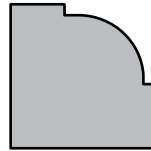

SWD 3146 | $\frac{3}{4}'' \times \frac{3}{4}''$

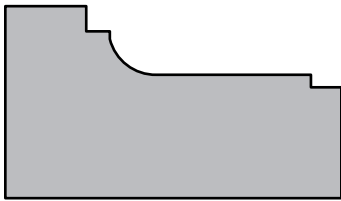

SWD 3147 | $1'' \times 1\frac{3}{4}''$

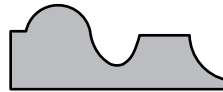

SWD 3148 | $\frac{7}{16}'' \times 1\frac{1}{8}''$

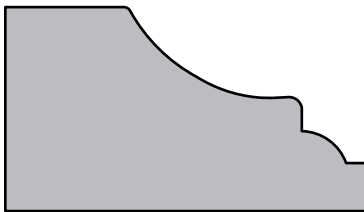

SWD 3149 | $1\frac{1}{16}'' \times 1\frac{7}{8}''$



SWD 3150 | $\frac{5}{8}'' \times 2\frac{7}{16}''$

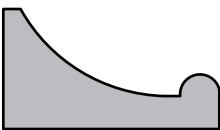

SWD 3151 | $\frac{5}{8}'' \times 1\frac{1}{8}''$



SWD 3152 | $\frac{9}{16}'' \times 1\frac{15}{16}''$



SWD 3153 | $\frac{5}{8}'' \times 1\frac{1}{8}''$

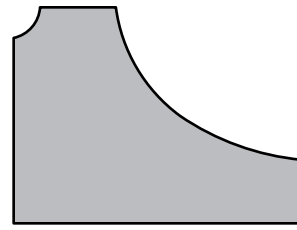

SWD 3154 | $1\frac{1}{8}'' \times 1\frac{1}{2}''$



SWD 3155 | $\frac{7}{16}'' \times 1\frac{5}{16}''$

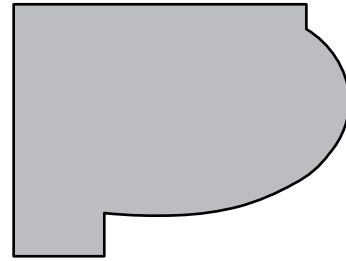

SWD 3156 | $1\frac{5}{16}'' \times 1\frac{3}{4}''$

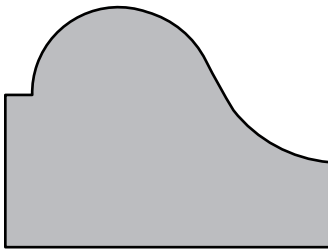

SWD 3157 | $1\frac{1}{4}'' \times 1\frac{11}{16}''$

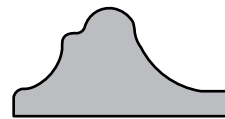

SWD 3158 | $\frac{9}{16}'' \times 1\frac{1}{8}''$



SWD 3159 | $\frac{9}{16}'' \times 1\frac{1}{4}''$



SWD 3160 | $\frac{7}{16}'' \times 1\frac{3}{16}''$

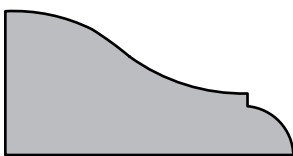

SWD 3161 | $\frac{3}{4}'' \times 1\frac{1}{2}''$

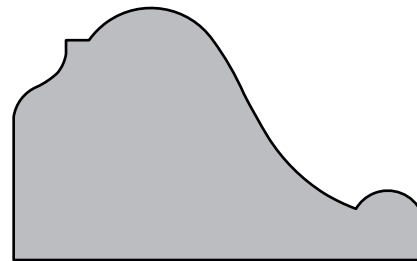

SWD 3162 | $1\frac{5}{16}'' \times 2\frac{1}{8}''$

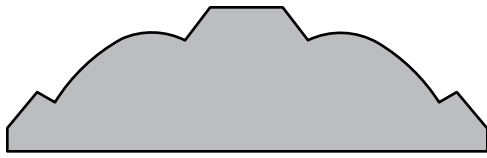

SWD 3163 | $\frac{3}{4}'' \times 2\frac{1}{2}''$

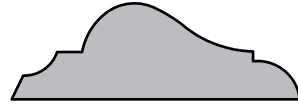

SWD 3164 | $\frac{1}{2}'' \times 1\frac{1}{2}''$

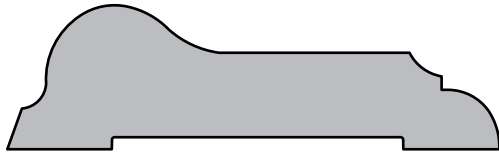

SWD 3165 | $\frac{3}{4}'' \times 2\frac{9}{16}''$

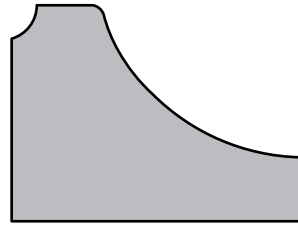

SWD 3166 | $1\frac{1}{8}'' \times 1\frac{1}{2}''$

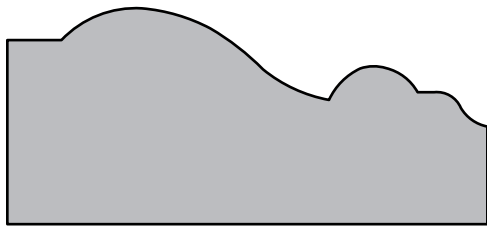

SWD 3167 | $1\frac{1}{8}'' \times 2\frac{1}{2}''$



SWD 3168 | $\frac{1}{4}'' \times \frac{9}{16}''$

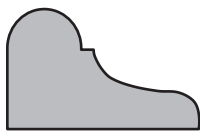

SWD 3169 | $\frac{5}{8}'' \times 1''$



SWD 3170 | $\frac{1}{2}'' \times \frac{3}{4}''$

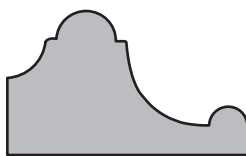

SWD 3171 | $\frac{3}{4}'' \times 1\frac{1}{4}''$

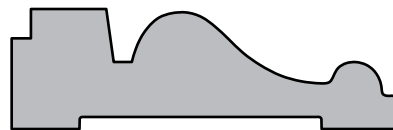

SWD 3172 | $\frac{5}{8}'' \times 2''$

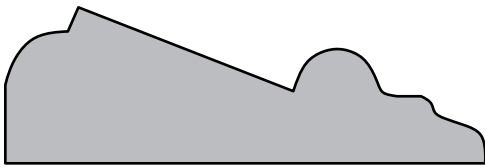

SWD 3173 | $1\frac{3}{16}'' \times 2\frac{1}{2}''$

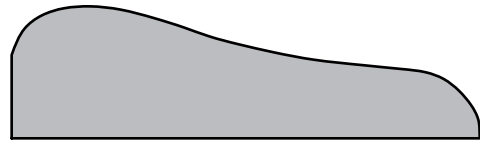

SWD 3174 | $1\frac{1}{16}'' \times 2\frac{7}{16}''$



SWD 3175 | $\frac{9}{16}'' \times 1\frac{13}{16}''$

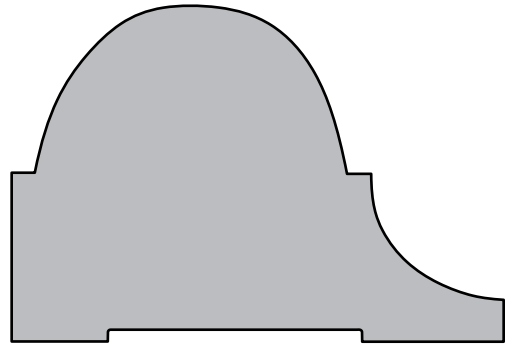

SWD 3176 | $1\frac{3}{4}'' \times 2\frac{9}{16}''$



SWD 3177 | $\frac{1}{2}'' \times 1\frac{5}{16}''$

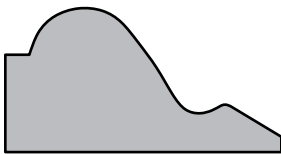

SWD 3178 | $\frac{3}{4}'' \times 1\frac{7}{16}''$

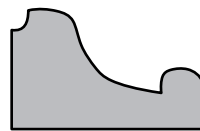

SWD 3179 | $\frac{5}{8}'' \times 1''$

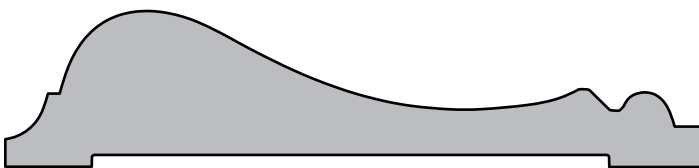

SWD 3180 | $1\frac{3}{16}'' \times 3\frac{5}{8}''$

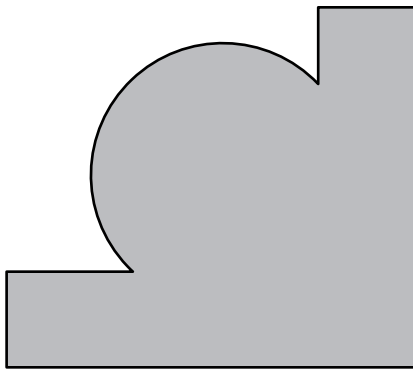

SWD 3181 | $1\frac{7}{8}'' \times 2\frac{1}{8}''$

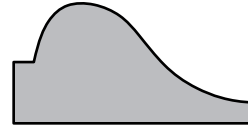

SWD 3182 | $\frac{5}{8}'' \times 1\frac{1}{4}''$

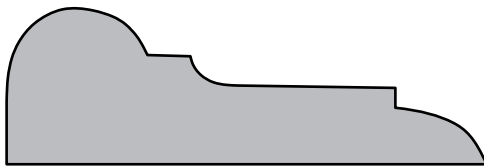

SWD 3183 | $1\frac{3}{16}'' \times 2\frac{1}{2}''$



SWD 3184 | $\frac{5}{16}'' \times \frac{3}{4}''$

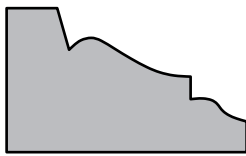

SWD 3185 | $\frac{3}{4}'' \times 1\frac{1}{4}''$

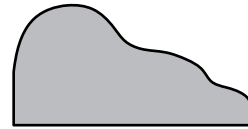

SWD 3186 | $\frac{5}{8}'' \times 1\frac{1}{4}''$

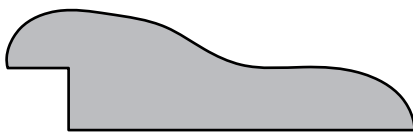

SWD 3187 | $\frac{5}{8}'' \times 2\frac{1}{8}''$

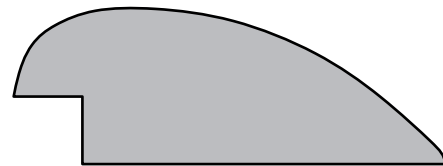

SWD 3188 | $1\frac{3}{16}'' \times 2\frac{1}{4}''$

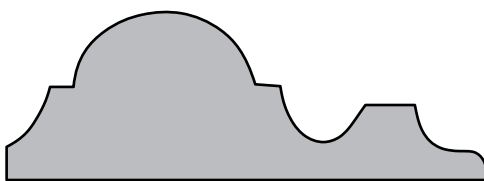

SWD 3189 | $\frac{7}{8}'' \times 2\frac{1}{2}''$

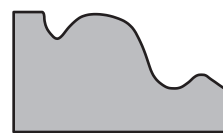

SWD 3190 | $\frac{5}{8}'' \times 1\frac{1}{8}''$

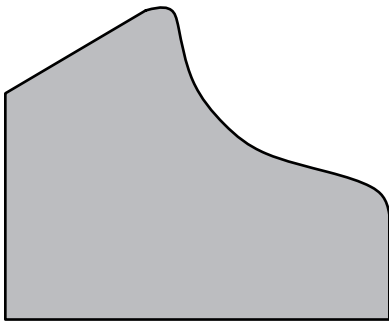

SWD 3191 | $1\frac{5}{8}'' \times 2''$

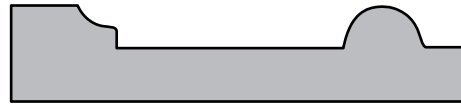

SWD 3192 | $\frac{1}{2}'' \times 2\frac{3}{8}''$

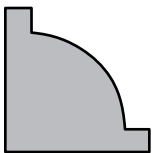

SWD 3193 | $\frac{3}{4}'' \times \frac{3}{4}''$



SWD 3194 | $\frac{5}{8}'' \times 2\frac{1}{16}''$

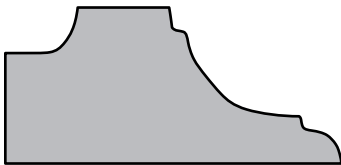

SWD 3195 | $1\frac{3}{16}'' \times 1\frac{3}{4}''$



SWD 3196 | $\frac{3}{4}'' \times 2\frac{1}{2}''$

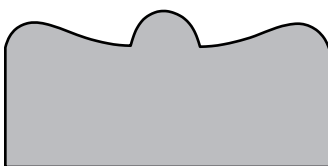

SWD 3197 | $1\frac{3}{16}'' \times 1\frac{11}{16}''$

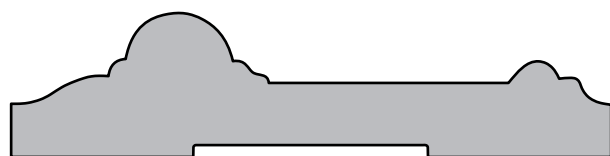

SWD 3198 | $\frac{3}{4}'' \times 3\frac{1}{8}''$

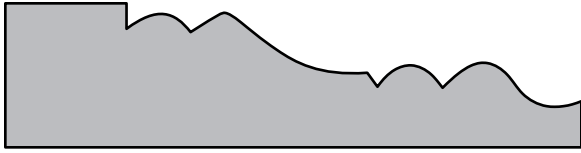

SWD 3199 | $\frac{3}{4}'' \times 3''$

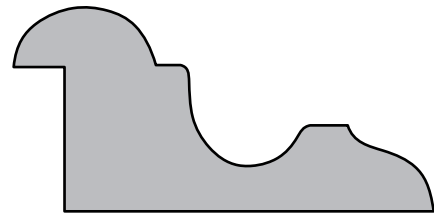

SWD 3200 | $1\frac{1}{16}'' \times 2\frac{3}{16}''$

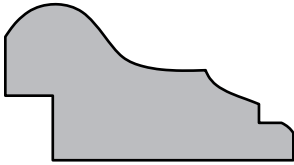

SWD 3201 | $1\frac{3}{16}'' \times 1\frac{1}{2}''$

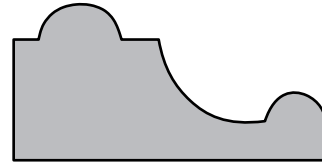

SWD 3202 | $1\frac{3}{16}'' \times 1\frac{5}{8}''$

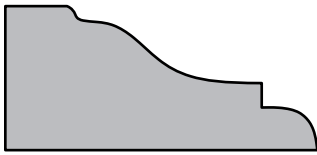

SWD 3203 | $\frac{3}{4}'' \times 1\frac{5}{8}''$

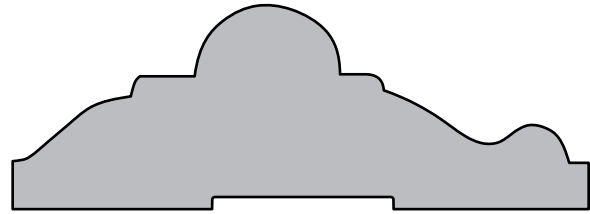

SWD 3204 | $1\frac{1}{16}'' \times 3''$

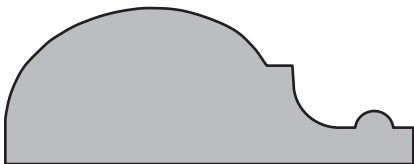

SWD 3205 | $1\frac{3}{16}'' \times 2\frac{1}{8}''$

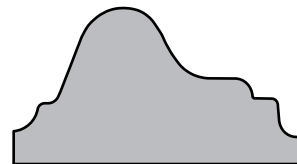

SWD 3206 | $1\frac{3}{16}'' \times 1\frac{1}{2}''$

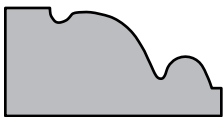

SWD 3207 | $\frac{9}{16}'' \times 1\frac{1}{8}''$



SWD 3208 | $\frac{3}{8}'' \times 1''$

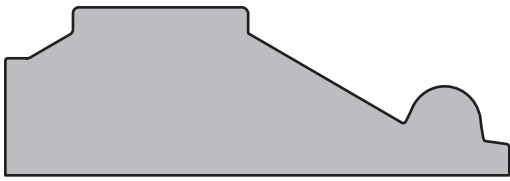

SWD 3209 | $\frac{7}{8}'' \times 2\frac{5}{8}''$

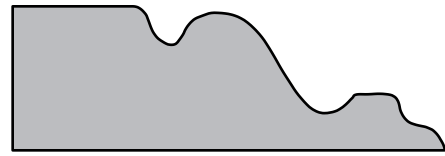

SWD 3210 | $\frac{3}{4}'' \times 2\frac{1}{4}''$

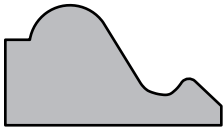

SWD 3211 | $\frac{5}{8}'' \times 1\frac{1}{8}''$

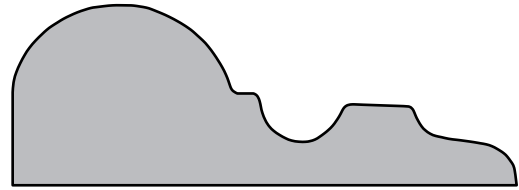

SWD 3212 | $1\frac{5}{16}'' \times 2\frac{5}{8}''$

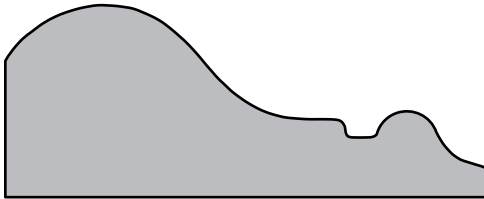

SWD 3213 | $1'' \times 2\frac{1}{2}''$

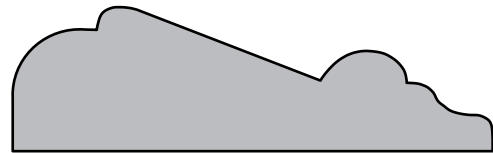

SWD 3214 | $\frac{3}{4}'' \times 2\frac{1}{2}''$

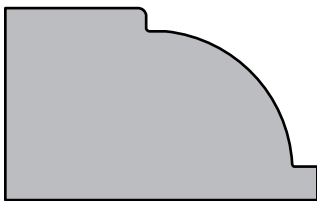

SWD 3215 | $1'' \times 1\frac{5}{8}''$



SWD 3216 | $1'' \times 2\frac{3}{4}''$

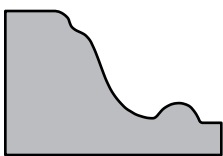

SWD 3217 | $\frac{3}{4}'' \times 1\frac{1}{8}''$



SWD 3218 | $1\frac{3}{16}'' \times 2\frac{3}{4}''$



SWD 3219 | $\frac{3}{4}'' \times 4\frac{15}{16}''$

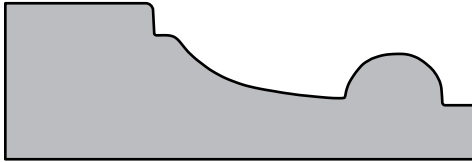

SWD 3220 | $1\frac{3}{16}'' \times 2\frac{7}{16}''$

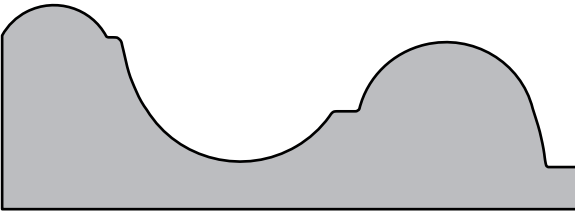

SWD 3221 | $1\frac{1}{16}'' \times 3''$

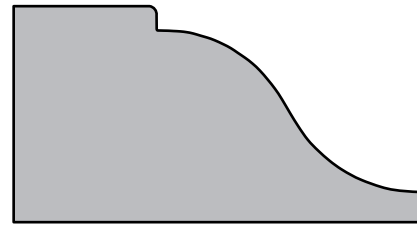

SWD 3222 | $1\frac{1}{8}'' \times 2\frac{1}{8}''$

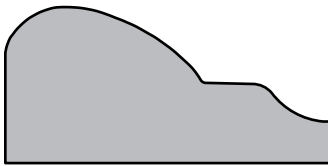

SWD 3223 | $1\frac{3}{16}'' \times 1\frac{11}{16}''$

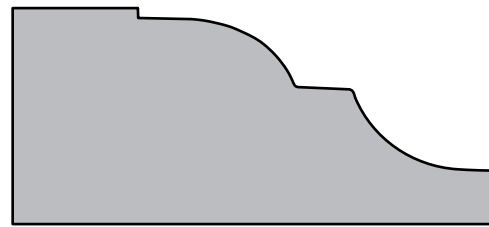

SWD 3224 | $1\frac{1}{8}'' \times 2\frac{1}{4}''$



SWD 3225 | $\frac{3}{4}'' \times 4''$

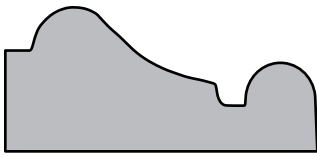

SWD 3226 | $\frac{3}{4}'' \times 1\frac{5}{8}''$

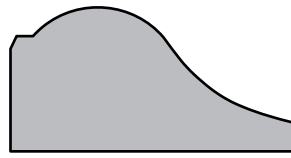

SWD 3227 | $\frac{3}{4}'' \times 1\frac{1}{2}''$

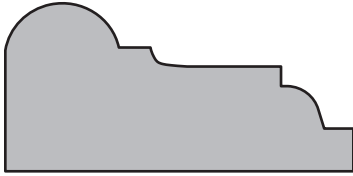

SWD 3228 | $\frac{7}{8}'' \times 1\frac{13}{16}''$

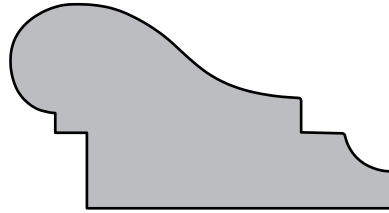

SWD 3229 | $1\frac{1}{16}'' \times 2''$

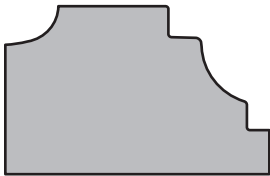

SWD 3230 | $\frac{7}{8}'' \times 1\frac{3}{8}''$

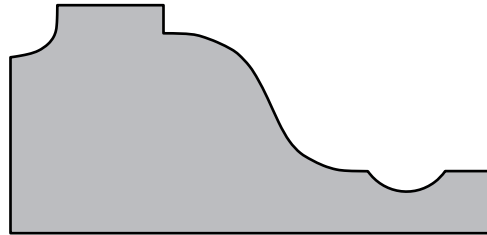

SWD 3231 | $1\frac{3}{16}'' \times 2\frac{1}{2}''$

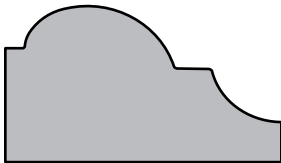

SWD 3232 | $1\frac{3}{16}'' \times 1\frac{7}{16}''$

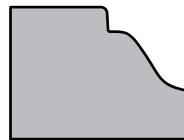

SWD 3233 | $1\frac{1}{16}'' \times 1\frac{3}{16}''$

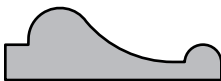

SWD 3234 | $\frac{3}{8}'' \times 1\frac{1}{8}''$

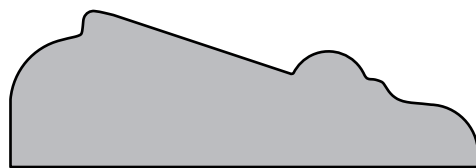

SWD 3235 | $1\frac{3}{16}'' \times 2\frac{7}{16}''$

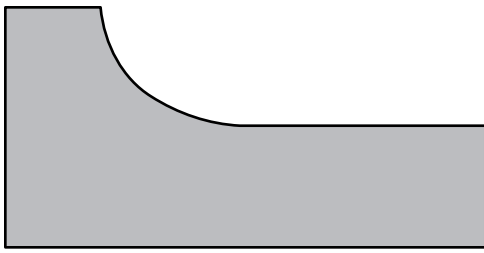

SWD 3236 | $1\frac{1}{4}'' \times 2\frac{1}{2}''$

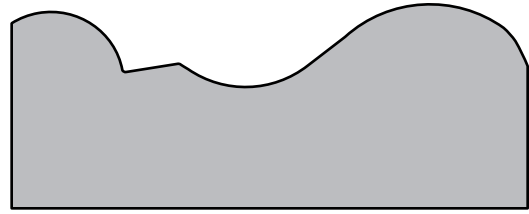

SWD 3237 | $1\frac{1}{16}'' \times 2\frac{11}{16}''$

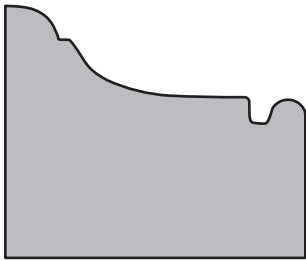

SWD 3238 | $1\frac{5}{16}'' \times 1\frac{1}{16}''$

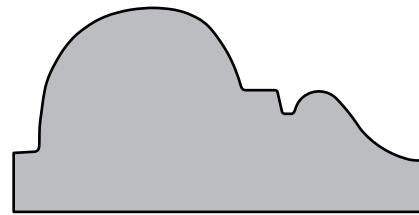

SWD 3239 | $1\frac{1}{16}'' \times 2\frac{1}{8}''$

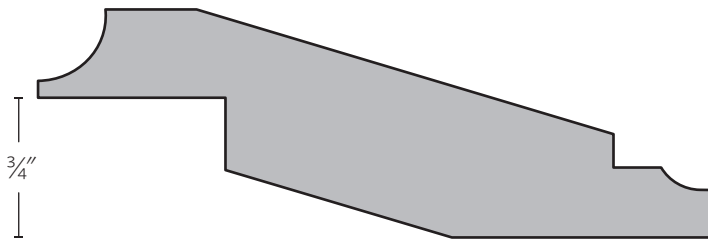

SWD 3240 | $1\frac{3}{16}'' \times 3''$

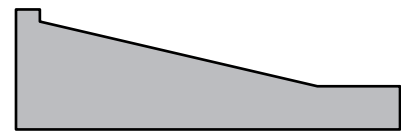

SWD 3241 | $\frac{5}{8}'' \times 2''$



SWD 3242 | $1\frac{1}{16}'' \times 1\frac{3}{16}''$

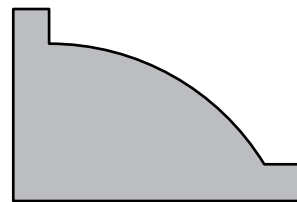

SWD 3243 | $1'' \times 1\frac{1}{2}''$

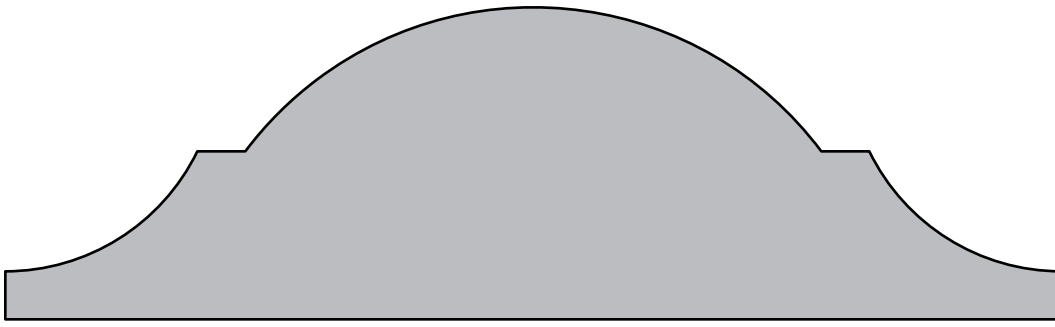

SWD 3244 | $1\frac{5}{8}'' \times 5\frac{1}{2}''$



SWD 3245 | $\frac{1}{4}'' \times 1\frac{3}{16}''$

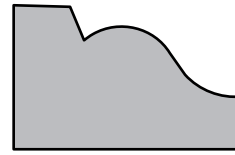

SWD 3246 | $\frac{3}{4}'' \times 1\frac{3}{16}''$

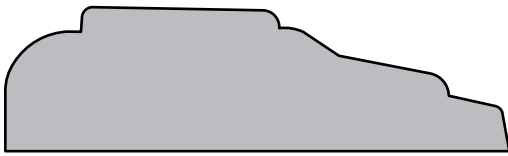

SWD 3247 | $\frac{3}{4}'' \times 2\frac{5}{8}''$

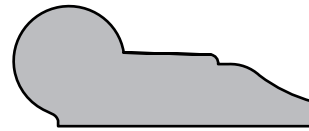

SWD 3248 | $\frac{5}{8}'' \times 1\frac{9}{16}''$



SWD 3249 | $\frac{9}{16}'' \times 1\frac{1}{4}''$

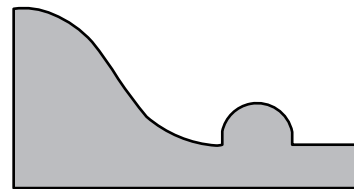

SWD 3250 | $1\frac{5}{16}'' \times 1\frac{13}{16}''$

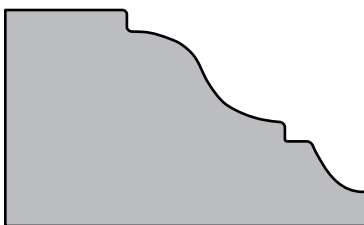

SWD 3251 | $1\frac{1}{8}'' \times 1\frac{7}{8}''$

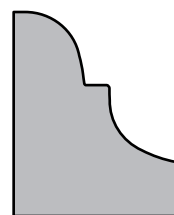

SWD 3252 | $1\frac{1}{16}'' \times \frac{7}{8}''$

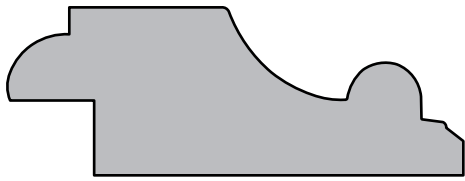

SWD 3253 | $\frac{7}{8}'' \times 2\frac{3}{8}''$

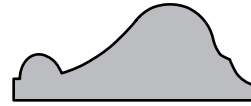

SWD 3254 | $\frac{1}{2}'' \times 1\frac{1}{4}''$

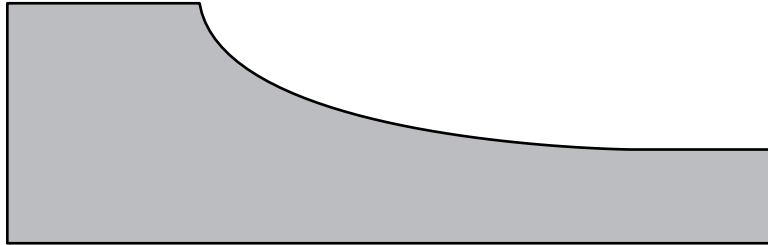

SWD 3255 | $1\frac{1}{4}'' \times 4''$



SWD 3256 | $\frac{1}{2}'' \times 1\frac{3}{8}''$

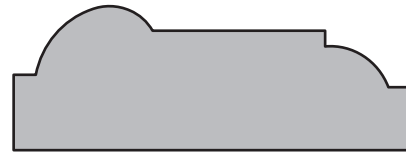

SWD 3257 | $\frac{3}{4}'' \times 2\frac{1}{16}''$

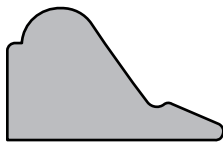

SWD 3258 | $1\frac{1}{16}'' \times 1\frac{1}{8}''$

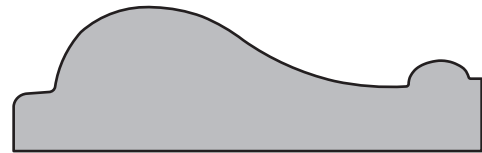

SWD 3259 | $\frac{3}{4}'' \times 2\frac{7}{16}''$



SWD 3260 | $\frac{9}{16}'' \times 3\frac{1}{8}''$

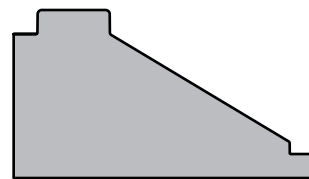

SWD 3261 | $\frac{7}{8}'' \times 1\frac{1}{16}''$

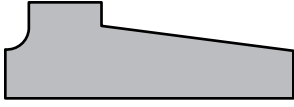

SWD 3262 | $\frac{1}{2}'' \times 1\frac{1}{2}''$

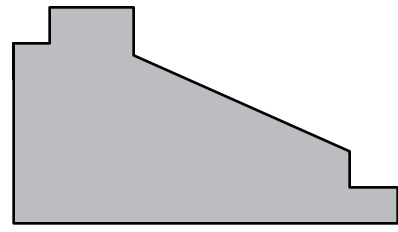

SWD 3263 | $1\frac{1}{8}'' \times 2''$

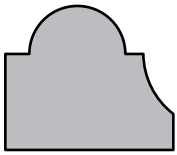

SWD 3264 | $\frac{3}{4}'' \times \frac{7}{8}''$

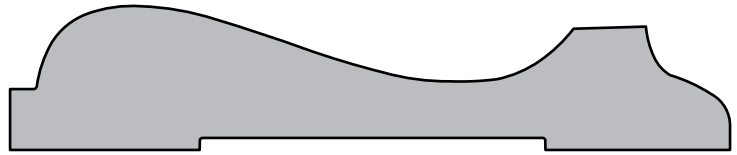

SWD 3265 | $\frac{3}{4}'' \times 3\frac{3}{4}''$

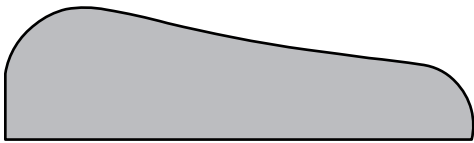

SWD 3266 | $1\frac{1}{16}'' \times 2\frac{7}{16}''$

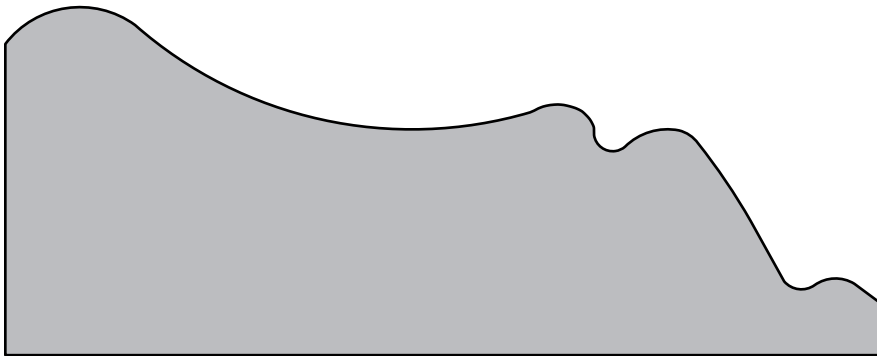

SWD 3267 | $1\frac{13}{16}'' \times 4\frac{9}{16}''$

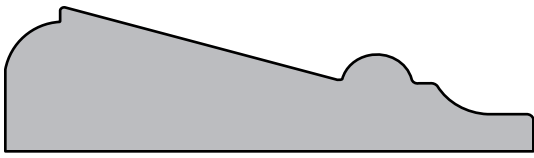

SWD 3268 | $\frac{3}{4}'' \times 2\frac{3}{4}''$

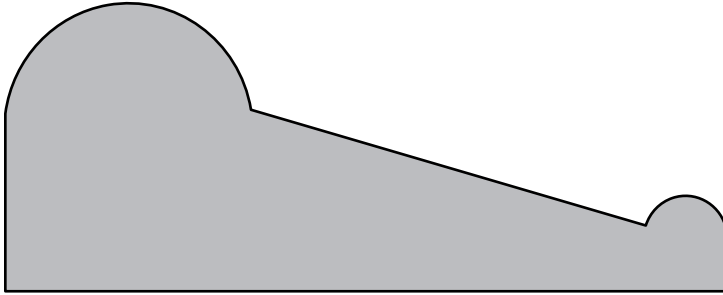

SWD 3269 | $1\frac{1}{2}'' \times 3\frac{3}{4}''$

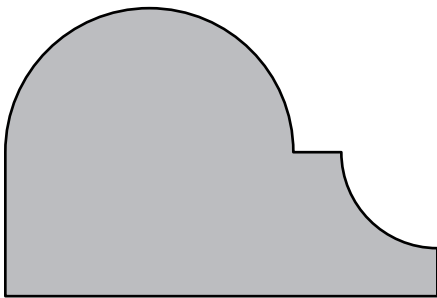

SWD 3270 | $1\frac{1}{2}'' \times 2\frac{1}{4}''$

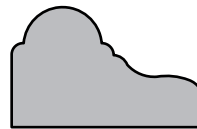

SWD 3271 | $\frac{5}{8}'' \times 1''$

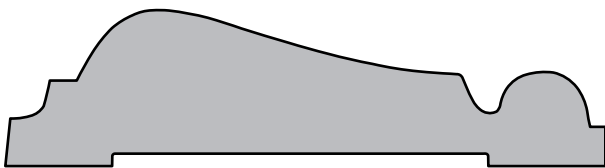

SWD 3272 | $1\frac{3}{16}'' \times 3\frac{1}{8}''$

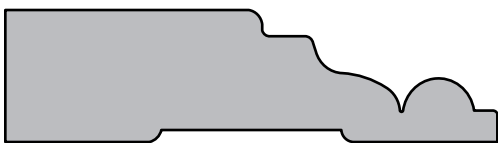

SWD 3273 | $1\frac{1}{16}'' \times 2\frac{9}{16}''$

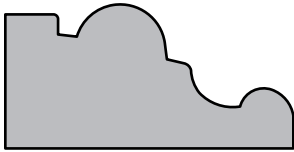

SWD 3274 | $\frac{3}{4}'' \times 1\frac{1}{2}''$

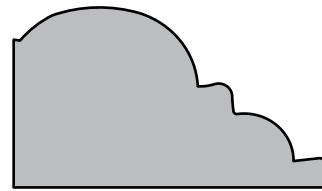

SWD 3275 | $1\frac{5}{16}'' \times 1\frac{5}{8}''$

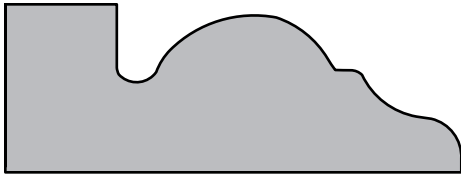

SWD 3276 | $\frac{7}{8}'' \times 2\frac{3}{8}''$

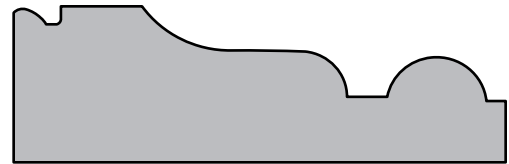

SWD 3277 | $1\frac{3}{16}'' \times 2\frac{9}{16}''$

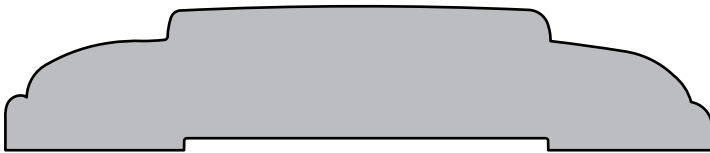

SWD 3278 | $\frac{3}{4}'' \times 3\frac{1}{16}''$

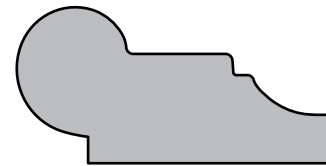

SWD 3279 | $1\frac{3}{16}'' \times 1\frac{5}{8}''$

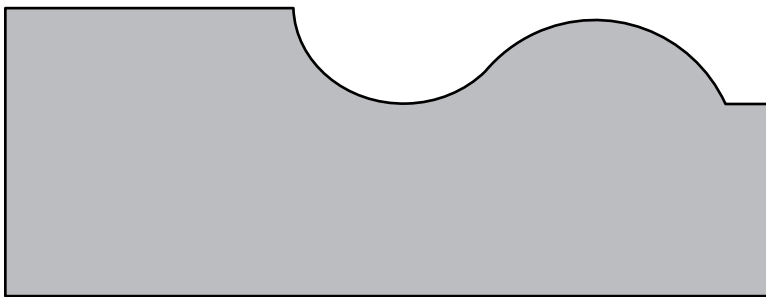

SWD 3280 | $1\frac{1}{2}'' \times 4''$

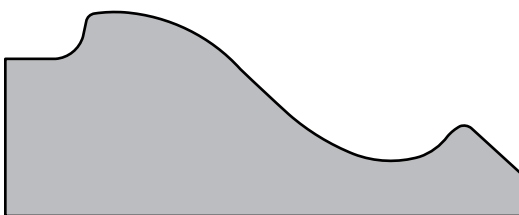

SWD 3281 | $1\frac{1}{16}'' \times 2\frac{1}{16}''$

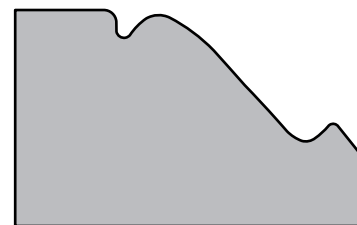

SWD 3282 | $1\frac{1}{8}'' \times 1\frac{13}{16}''$

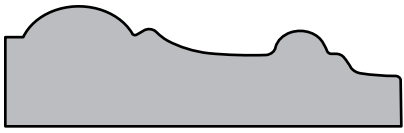

SWD 3283 | $\frac{5}{8}'' \times 2\frac{1}{16}''$



SWD 3284 | $\frac{3}{4}'' \times 3''$

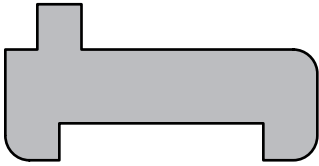

SWD 3285 | $1\frac{3}{16}'' \times 1\frac{5}{8}''$

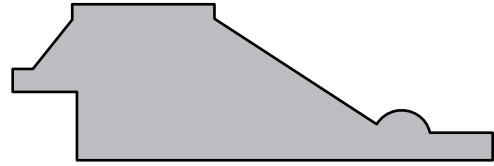

SWD 3286 | $1\frac{3}{16}'' \times 2\frac{1}{2}''$

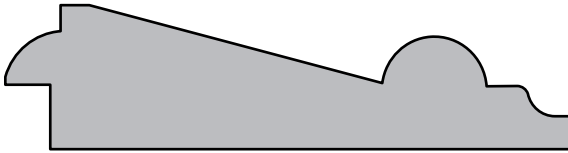

SWD 3287 | $\frac{3}{4}'' \times 2\frac{15}{16}''$

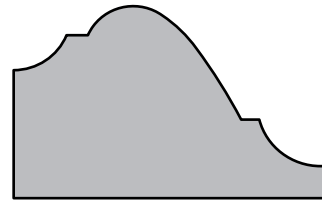

SWD 3288 | $1'' \times 1\frac{5}{8}''$

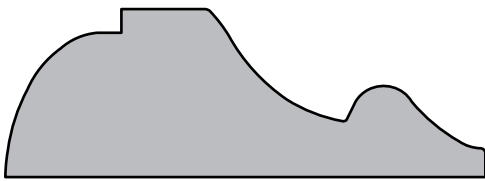

SWD 3289 | $\frac{7}{8}'' \times 2\frac{1}{2}''$

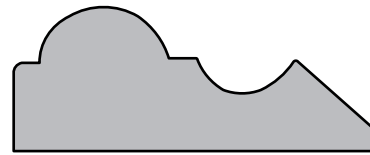

SWD 3290 | $\frac{3}{4}'' \times 1\frac{7}{8}''$

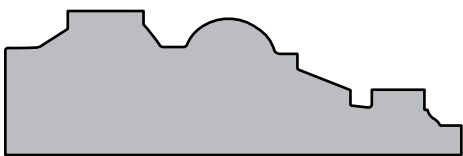

SWD 3291 | $\frac{3}{4}'' \times 2\frac{3}{8}''$

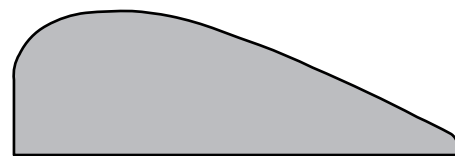

SWD 3292 | $\frac{3}{4}'' \times 2\frac{5}{16}''$

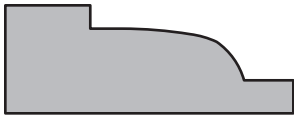

SWD 3293 | $\frac{9}{16}'' \times 1\frac{1}{2}''$



SWD 3294 | $\frac{7}{16}'' \times \frac{7}{8}''$



SWD 3295 | $\frac{1}{2}'' \times 1\frac{3}{16}''$

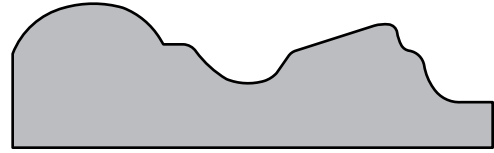

SWD 3296 | $\frac{3}{4}'' \times 2\frac{1}{2}''$



SWD 3297 | $\frac{1}{2}'' \times \frac{1}{2}''$



SWD 3298 | $\frac{1}{4}'' \times 1\frac{1}{2}''$



SWD 3299 | $1\frac{1}{16}'' \times 1\frac{7}{16}''$

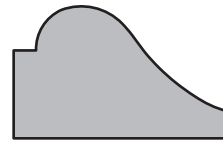

SWD 3300 | $1\frac{1}{16}'' \times 1\frac{1}{8}''$

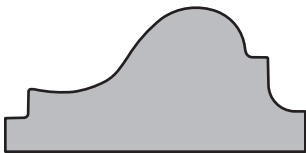

SWD 3301 | $\frac{3}{4}'' \times 1\frac{9}{16}''$

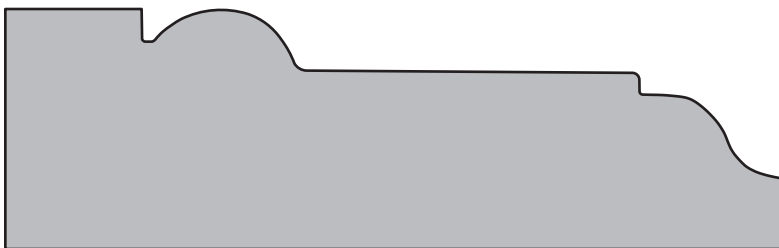

SWD 3302 | $1\frac{1}{4}'' \times 4\frac{1}{16}''$

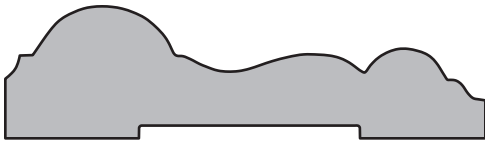

SWD 3303 | $1\frac{1}{16}'' \times 2\frac{1}{2}''$

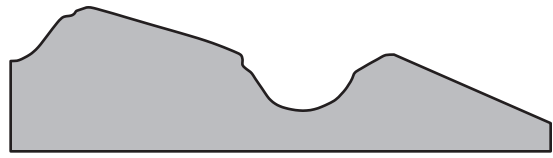

SWD 3304 | $\frac{3}{4}'' \times 2\frac{13}{16}''$

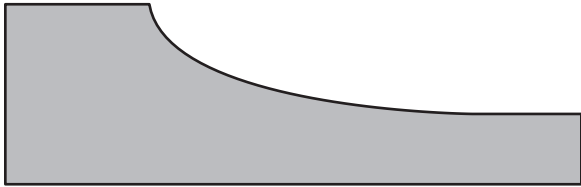

SWD 3305 | $1\frac{5}{16}'' \times 3''$

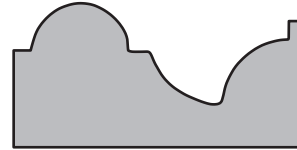

SWD 3306 | $\frac{3}{4}'' \times 1\frac{1}{2}''$

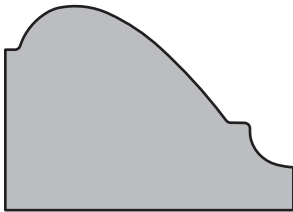

SWD 3307 | $1\frac{1}{16}'' \times 1\frac{1}{2}''$

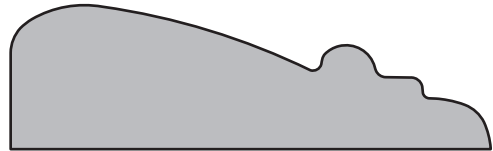

SWD 3308 | $\frac{3}{4}'' \times 2\frac{1}{2}''$

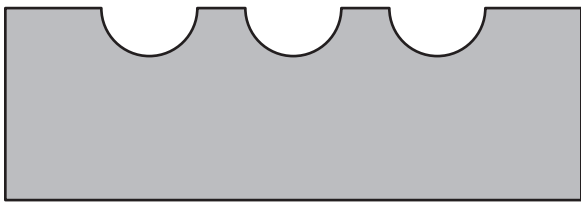

SWD 3309 | $1'' \times 3''$



SWD 3310 | $\frac{5}{16}'' \times 1''$



SWD 3311 | $\frac{5}{8}'' \times \frac{3}{4}''$

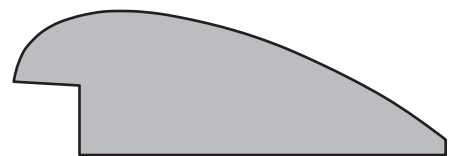

SWD 3312 | $\frac{3}{4}'' \times 2\frac{1}{4}''$

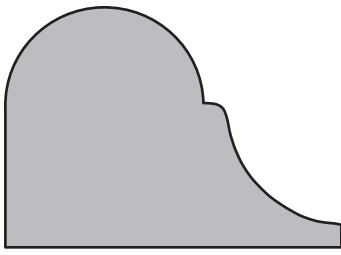

SWD 3313 | $1\frac{1}{4}'' \times 1\frac{3}{4}''$

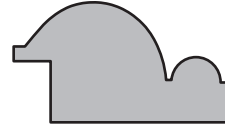

SWD 3314 | $1\frac{1}{8}'' \times \frac{5}{8}''$

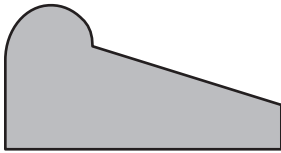

SWD 3315 | $\frac{3}{4}'' \times 1\frac{7}{16}''$



SWD 3316 | $\frac{3}{8}'' \times 1\frac{5}{16}''$

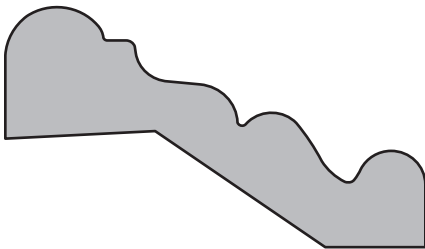

SWD 3317 | $1\frac{1}{4}'' \times 2\frac{3}{16}''$

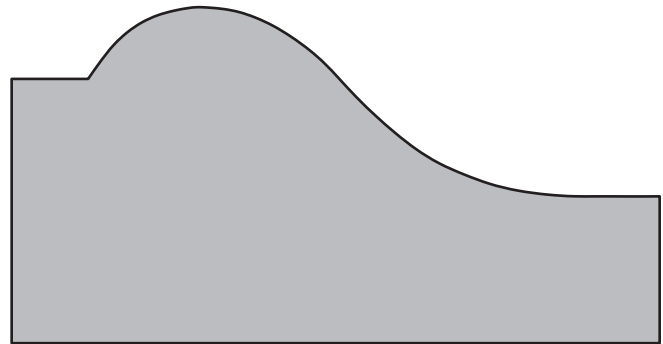

SWD 3318 | $1\frac{3}{4}'' \times 3\frac{3}{8}''$

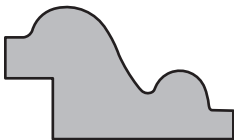

SWD 3319 | $1\frac{1}{16}'' \times 1\frac{3}{16}''$

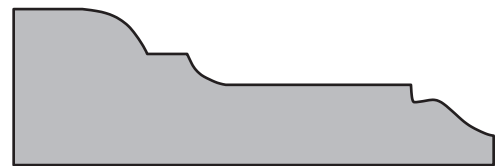

SWD 3320 | $1\frac{3}{16}'' \times 2\frac{1}{2}''$

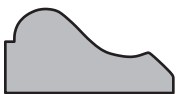

SWD 3321 | $\frac{7}{16}'' \times \frac{7}{8}''$



SWD 3322 | $\frac{1}{2}'' \times 1\frac{1}{16}''$

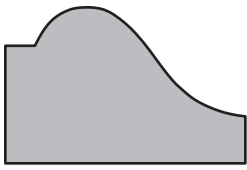

SWD 3323 | $1\frac{3}{16}'' \times 1\frac{1}{4}''$

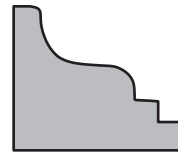

SWD 3324 | $\frac{3}{4}'' \times \frac{7}{8}''$

SECTION 4

Back Band Profiles

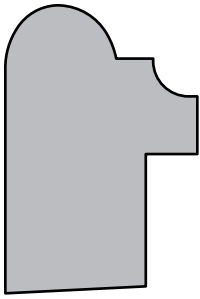

SWD 400 | 1" x 1½"

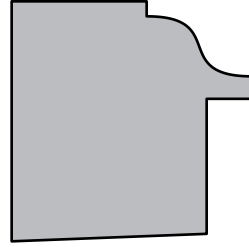

SWD 401 | 1¼" x 1¼"

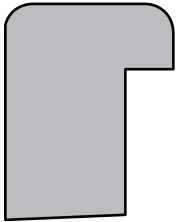

SWD 402 | 7⁄8" x 1½"

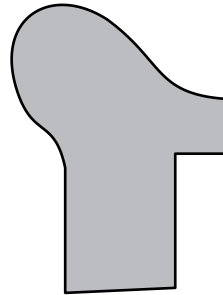

SWD 403 | 1½" x 1½"

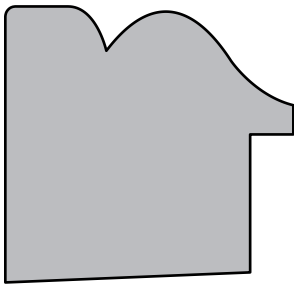

SWD 404 | 1½" x 1⅞"

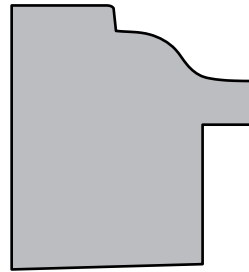

SWD 405 | 1¼" x 1⅜"

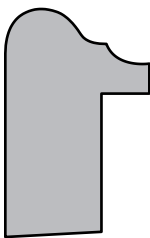

SWD 406 | ¾" x 1⅜"

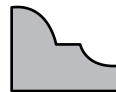

SWD 406-S | 7⁄16" x 9⁄16"

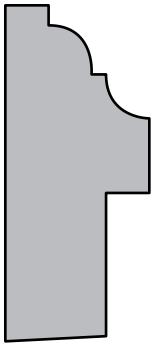

SWD 407 | $\frac{3}{4}'' \times 1\frac{3}{4}''$

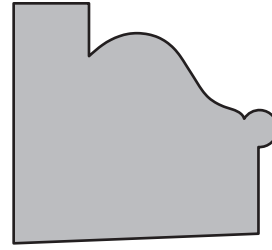

SWD 408 | $1\frac{1}{4}'' \times 1\frac{3}{8}''$

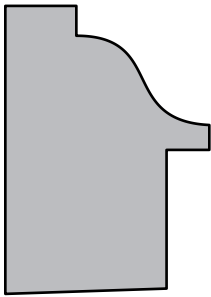

SWD 409 | $1\frac{1}{16}'' \times 1\frac{1}{2}''$

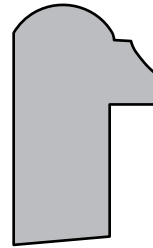

SWD 410 | $\frac{3}{4}'' \times 1\frac{1}{4}''$

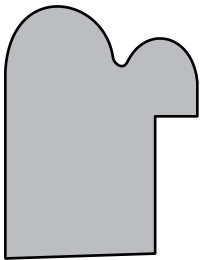

SWD 411 | $1'' \times 1\frac{5}{16}''$

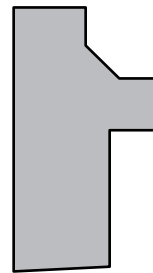

SWD 412 | $\frac{3}{4}'' \times 1\frac{3}{8}''$

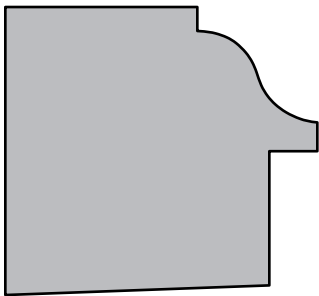

SWD 413 | $1\frac{5}{8}'' \times 1\frac{1}{2}''$

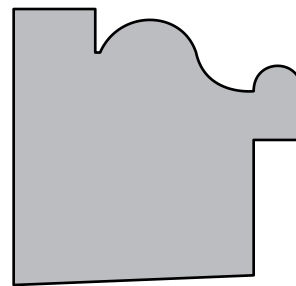

SWD 414 | $1\frac{7}{16}'' \times 1\frac{1}{2}''$

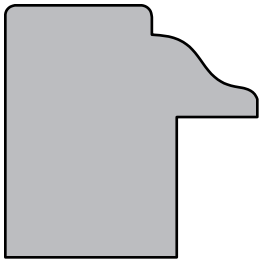

SWD 415 | $1\frac{5}{16}'' \times 1\frac{5}{16}''$

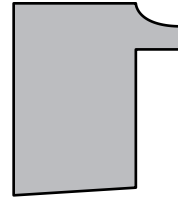

SWD 416 | $\frac{7}{8}'' \times 1''$

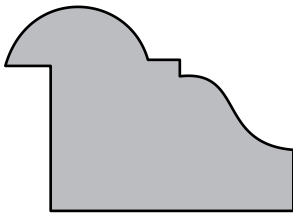

SWD 417 | $1\frac{1}{16}'' \times 1\frac{1}{2}''$

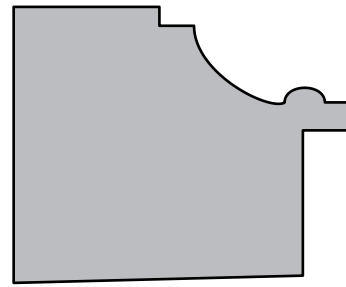

SWD 418 | $1\frac{7}{16}'' \times 1\frac{3}{4}''$

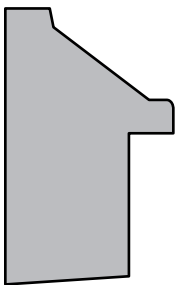

SWD 419 | $\frac{7}{8}'' \times 1\frac{7}{16}''$

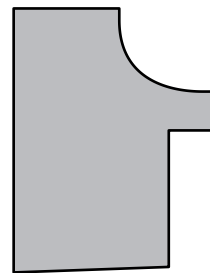

SWD 420 | $1\frac{1}{16}'' \times 1\frac{3}{8}''$

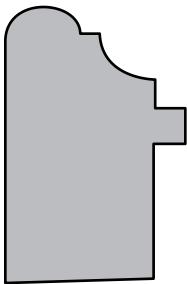

SWD 421 | $1\frac{5}{16}'' \times 1\frac{7}{16}''$

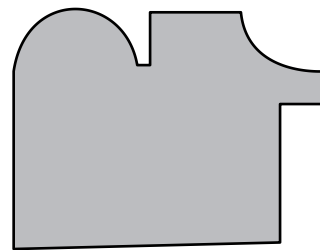

SWD 422 | $1\frac{1}{4}'' \times 1\frac{5}{8}''$

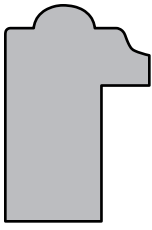

SWD 423 | $\frac{3}{4}'' \times 1\frac{1}{8}''$

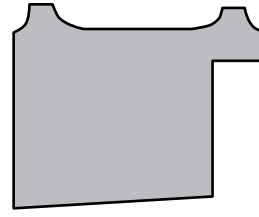

SWD 424 | $1\frac{5}{16}'' \times 1\frac{1}{16}''$

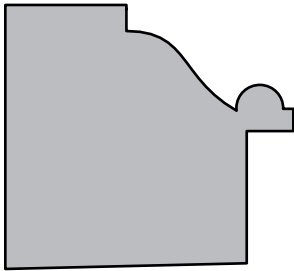

SWD 425 | $1\frac{1}{2}'' \times 1\frac{3}{8}''$

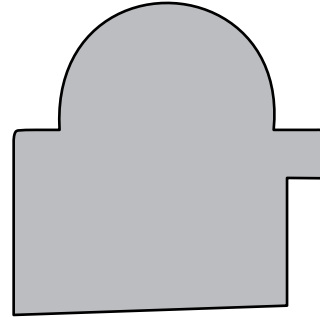

SWD 426 | $1\frac{5}{8}'' \times 1\frac{5}{8}''$

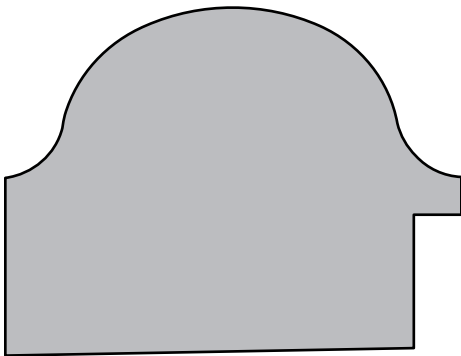

SWD 427 | $2\frac{3}{8}'' \times 1\frac{13}{16}''$

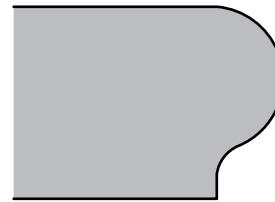

SWD 428 | Sill
 $1'' \times$ Customer Specs

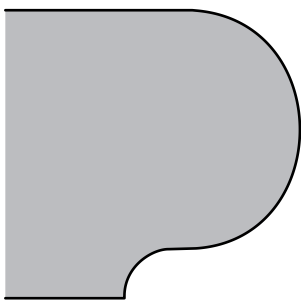

SWD 429 | Sill
 $1\frac{1}{2}'' \times$ Customer Specs



SWD 430 | Sill
 $\frac{3}{4}'' \times$ Customer Specs

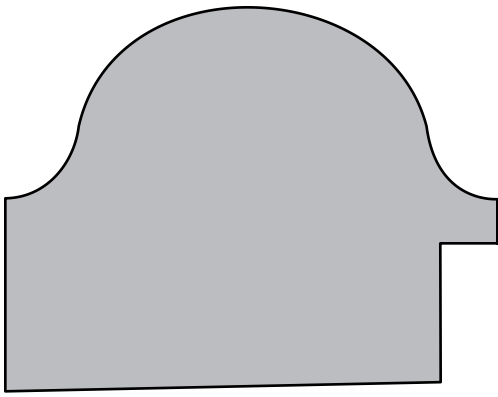

SWD 431 | $2\frac{9}{16}'' \times 2''$

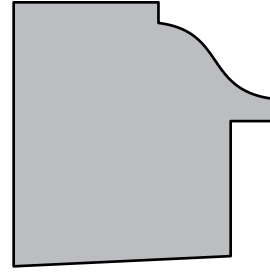

SWD 432 | $1\frac{3}{8}'' \times 1\frac{3}{8}''$

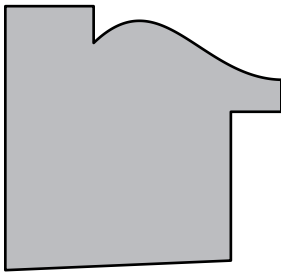

SWD 433 | $1\frac{3}{8}'' \times 1\frac{5}{16}''$

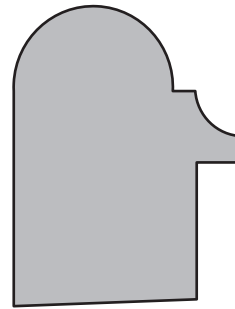

SWD 434 | $1\frac{3}{16}'' \times 1\frac{1}{16}''$

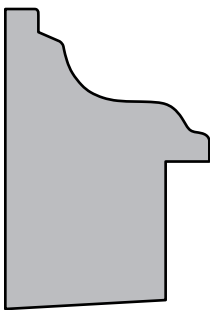

SWD 435 | $1\frac{1}{16}'' \times 1\frac{1}{16}''$

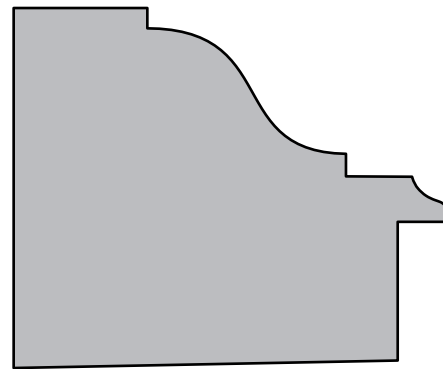

SWD 436 | $2\frac{1}{4}'' \times 1\frac{7}{8}''$

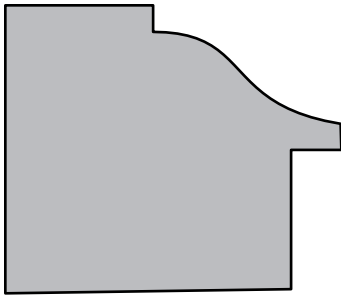

SWD 437 | $1\frac{3}{4}'' \times 1\frac{1}{2}''$

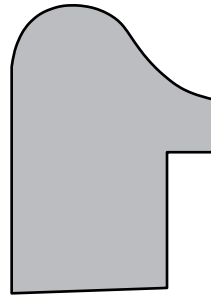

SWD 438 | $1\frac{1}{16}'' \times 1\frac{1}{2}''$

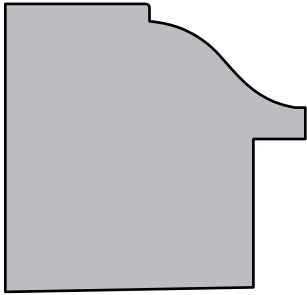

SWD 439 | $1\frac{9}{16}'' \times 1\frac{1}{2}''$

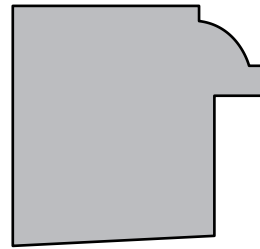

SWD 440 | $1\frac{1}{4}'' \times 1\frac{3}{16}''$

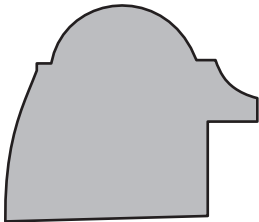

SWD 441 | $1\frac{1}{8}'' \times 1\frac{5}{16}''$

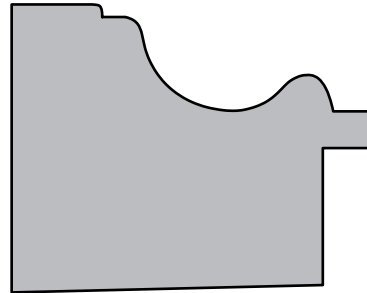

SWD 442 | $1\frac{7}{8}'' \times 1\frac{1}{2}''$

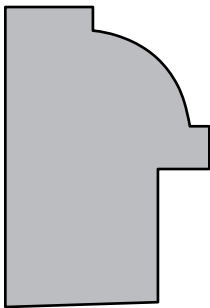

SWD 443 | $1\frac{1}{16}'' \times 1\frac{9}{16}''$

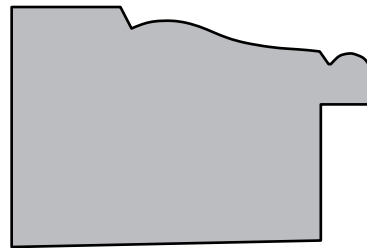

SWD 444 | $1\frac{7}{8}'' \times 1\frac{1}{4}''$

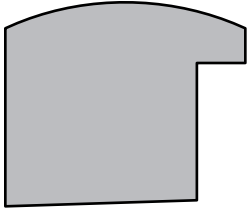

SWD 445 | $1\frac{1}{16}'' \times 1\frac{1}{4}''$

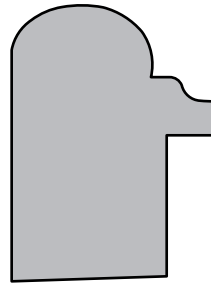

SWD 446 | $1\frac{1}{16}'' \times 1\frac{7}{16}''$

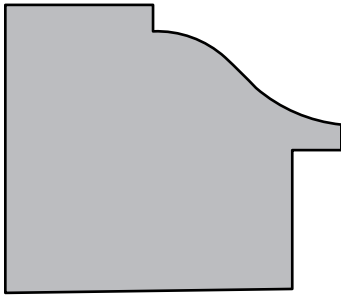

SWD 447 | $1\frac{3}{4}'' \times 1\frac{1}{2}''$

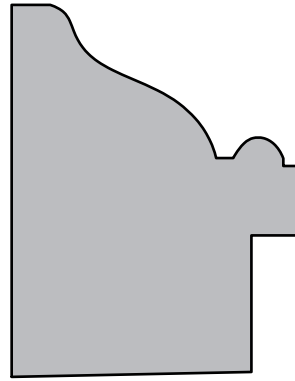

SWD 448 | $1\frac{1}{2}'' \times 1\frac{15}{16}''$

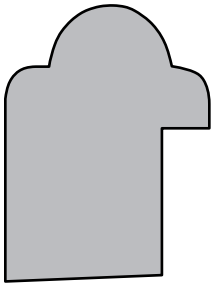

SWD 449 | $1\frac{1}{16}'' \times 1\frac{7}{16}''$

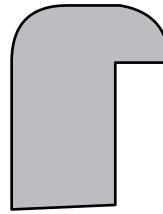

SWD 450 | $1\frac{3}{16}'' \times 1\frac{1}{16}''$

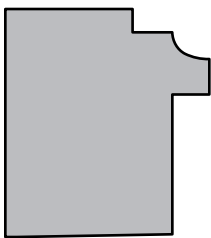

SWD 451 | $1\frac{1}{16}'' \times 1\frac{3}{16}''$

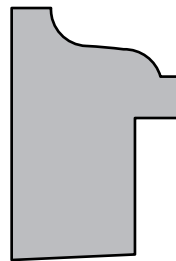

SWD 452 | $\frac{7}{8}'' \times 1\frac{5}{16}''$

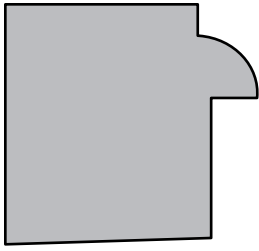

SWD 453 | $1\frac{1}{4}'' \times 1\frac{5}{16}''$

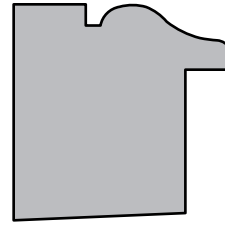

SWD 454 | $1\frac{1}{8}'' \times 1\frac{1}{8}''$

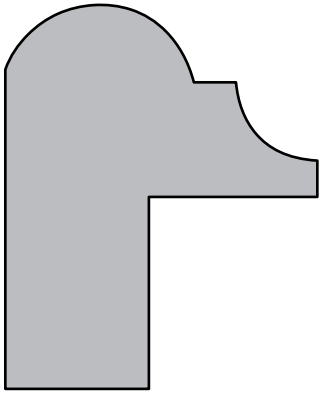

SWD 455 | $1\frac{5}{8}'' \times 2''$

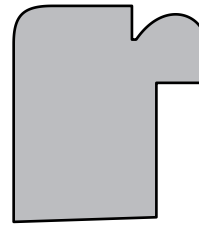

SWD 456 | $1'' \times 1\frac{1}{8}''$

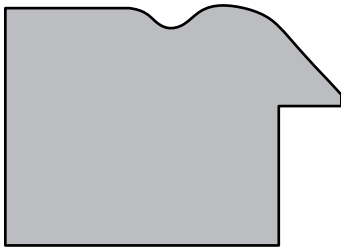

SWD 457 | $1\frac{1}{4}'' \times 1\frac{3}{4}''$

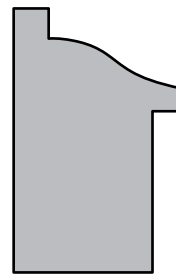

SWD 458 | $\frac{7}{8}'' \times 1\frac{3}{8}''$

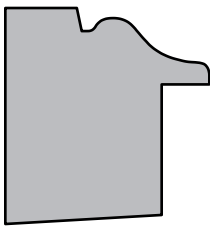

SWD 459 | $1\frac{3}{16}'' \times 1\frac{1}{16}''$

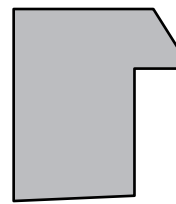

SWD 460 | $\frac{7}{8}'' \times 1''$

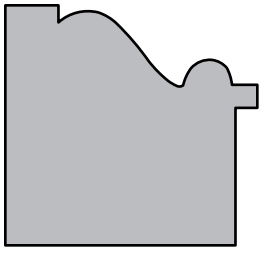

SWD 461 | $1\frac{1}{4}'' \times 1\frac{5}{16}''$

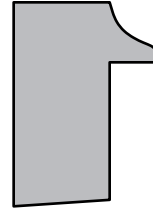

SWD 462 | $\frac{3}{4}'' \times 1\frac{1}{16}''$

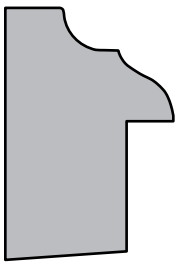

SWD 463 | $\frac{7}{8}'' \times 1\frac{5}{16}''$

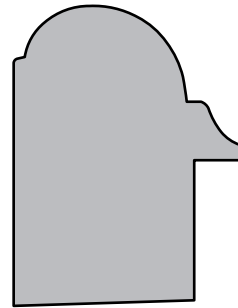

SWD 464 | $1\frac{9}{16}'' \times 1\frac{3}{16}''$

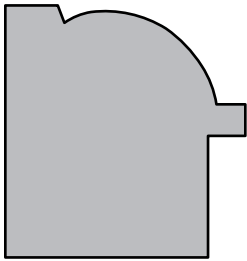

SWD 465 | $1\frac{5}{16}'' \times 1\frac{1}{4}''$

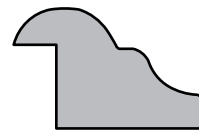

SWD 466 | $\frac{5}{8}'' \times 1''$

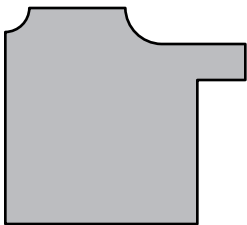

SWD 467 | $1\frac{1}{4}'' \times 1\frac{1}{8}''$

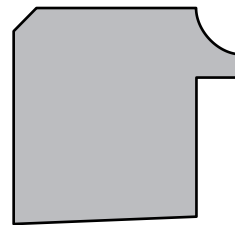

SWD 468 | $1\frac{1}{8}'' \times 1\frac{1}{4}''$

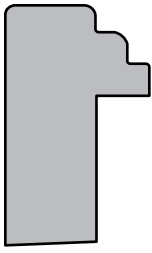

SWD 469 | $1\frac{1}{4}'' \times \frac{3}{4}''$

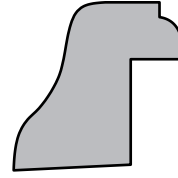

SWD 470 | $\frac{7}{8}'' \times \frac{7}{8}''$

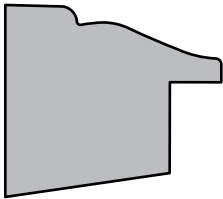

SWD 471 | $1\frac{1}{8}'' \times 1''$

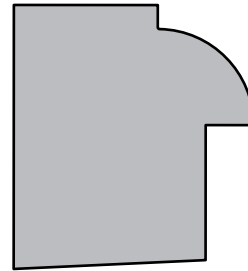

SWD 472 | $1\frac{1}{4}'' \times 1\frac{3}{8}''$

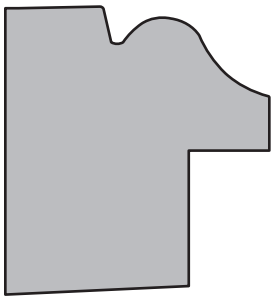

SWD 473 | $1\frac{1}{2}'' \times 1\frac{3}{8}''$

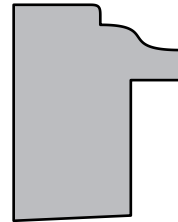

SWD 480
 $\frac{7}{8}'' \times 1\frac{1}{8}''$

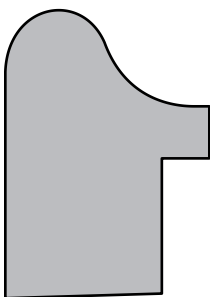

SWD 490
 $1\frac{1}{16}'' \times 1\frac{1}{2}''$

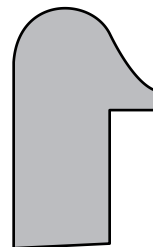

SWD 491
 $\frac{3}{4}'' \times 1\frac{1}{4}''$

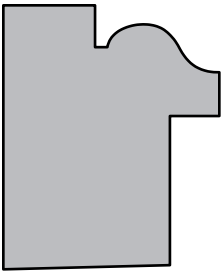

SWD 492
1 1/8" x 1 3/8"

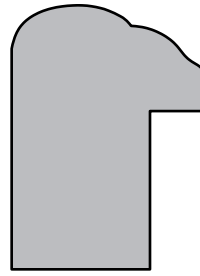

SWD 493
1" x 1 3/8"

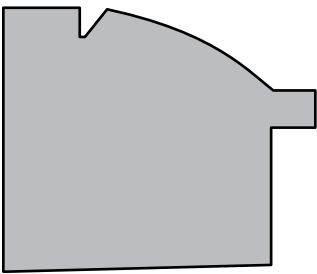

SWD 494 | 1 3/8" x 1 5/8"

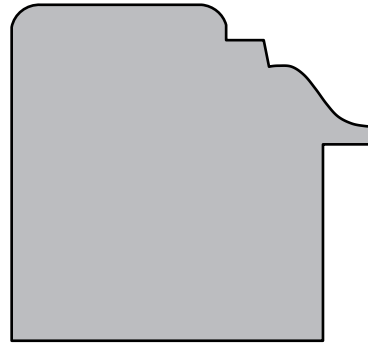

SWD 495 | 1 7/8" x 1 3/4"

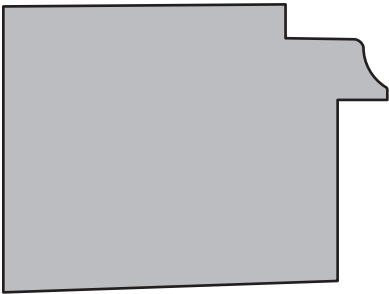

SWD 496 | 1 1/2" x 2"

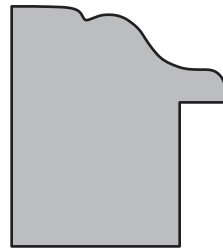

SWD 497 | 1 1/4" x 1 1/8"

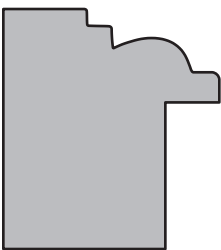

SWD 498 | 1 1/4" x 1 1/8"

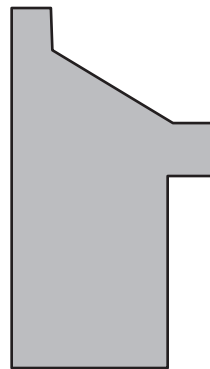

SWD 499 | 1 1/16" x 1 7/8"

SECTION 5

Crown Profiles

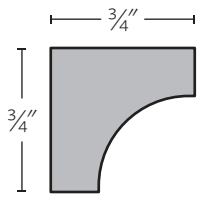

SWD 500 | $\frac{3}{4}'' \times \frac{3}{4}''$

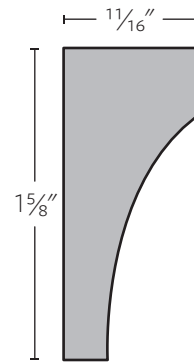

SWD 501 | $1\frac{1}{16}'' \times 1\frac{5}{8}''$

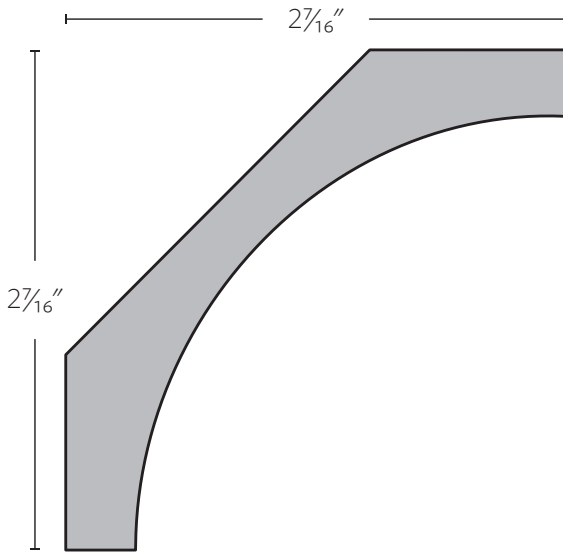

SWD 502 | $1\frac{3}{16}'' \times 3\frac{1}{2}''$ | 45/45

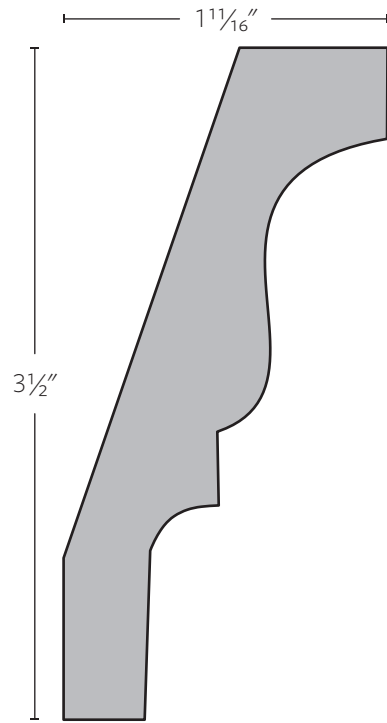

SWD 504 | $\frac{7}{8}'' \times 3\frac{3}{4}''$ | 19/71

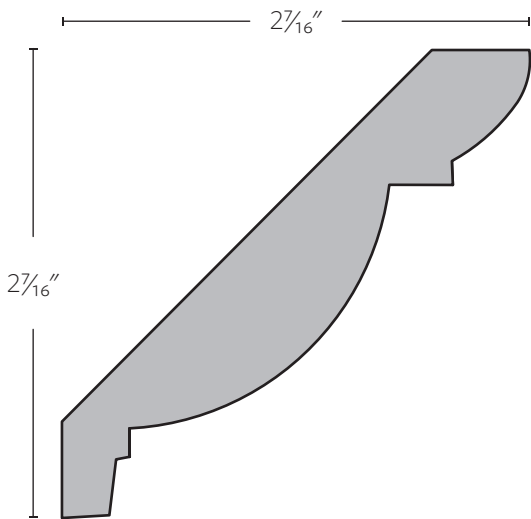

SWD 503 | $\frac{5}{8}'' \times 3\frac{1}{2}''$ | 45/45

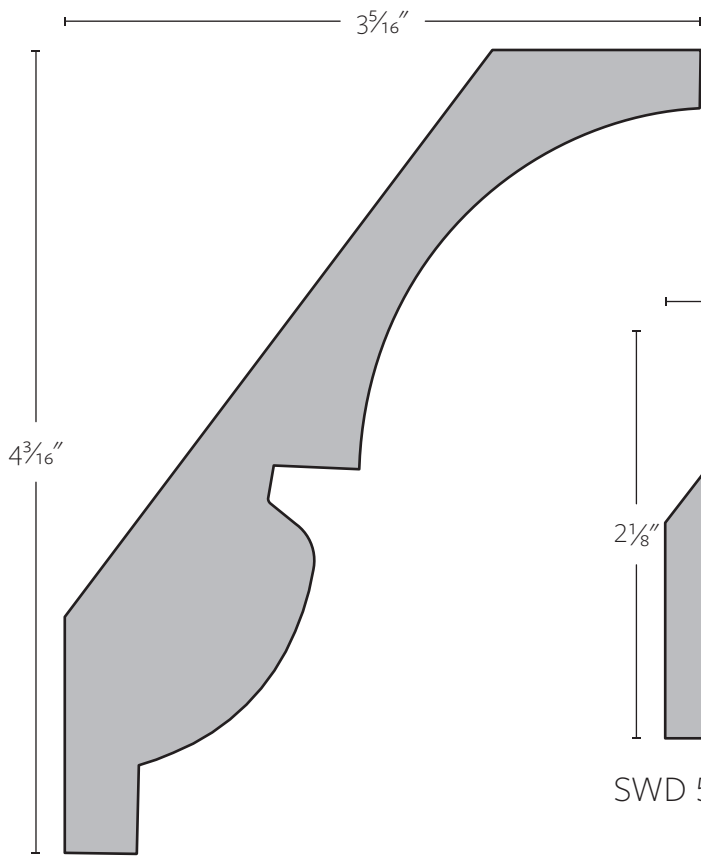

SWD 505 | 1 1/16" x 5 5/16" | 38/52

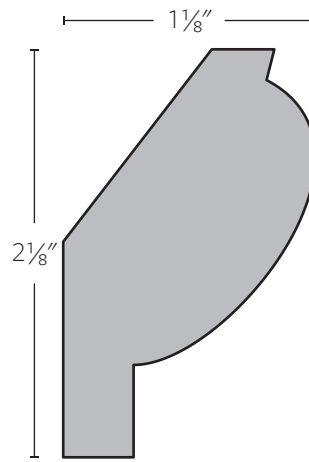

SWD 505-B | 1 1/16" x 2 1/4" | 38/52

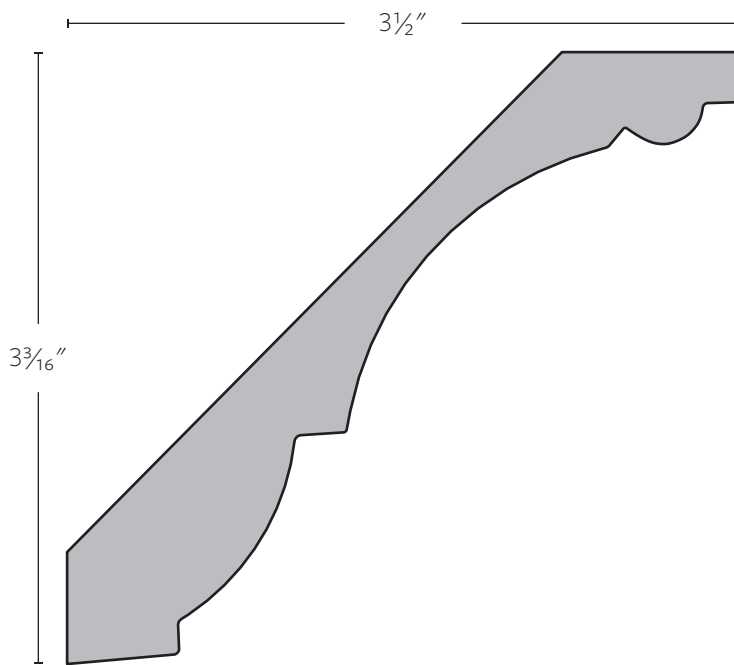

SWD 506 | 1 3/16" x 4 5/8" | 45/45

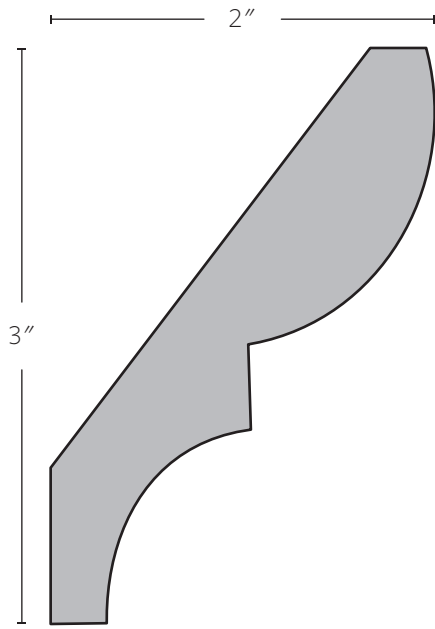

SWD 507 | $\frac{3}{4}'' \times 3\frac{1}{2}''$ | 38/52

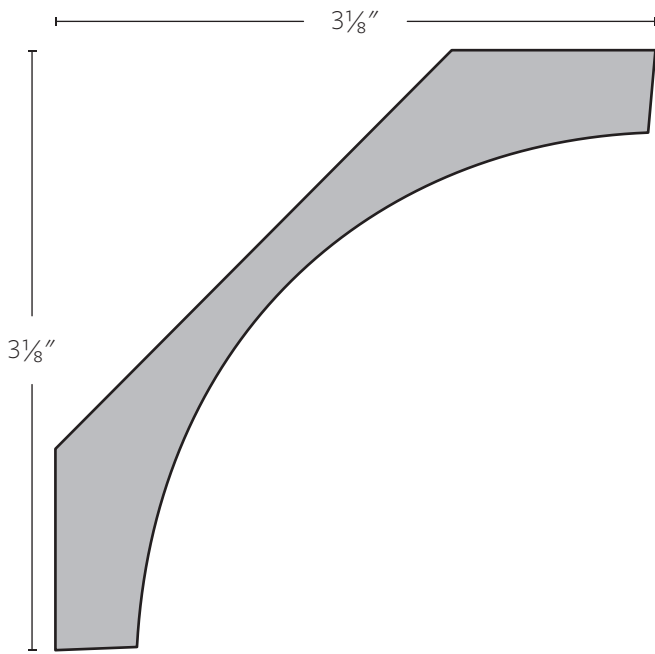

SWD 508 | $1'' \times 4\frac{3}{8}''$ | 45/45

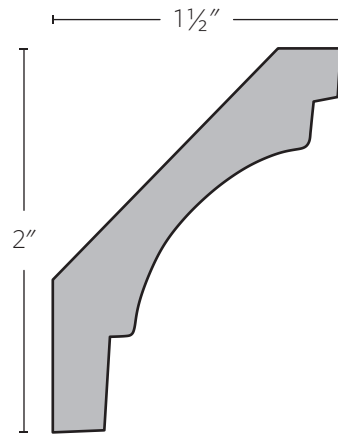

SWD 509 | $\frac{3}{4}'' \times 2\frac{1}{2}''$ | 45/45

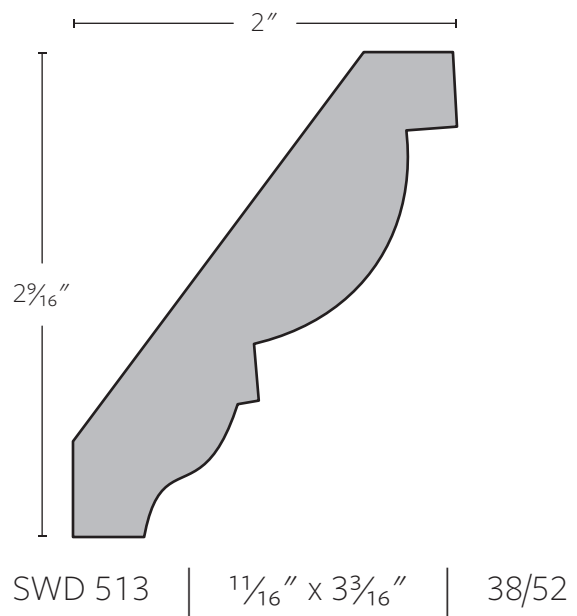
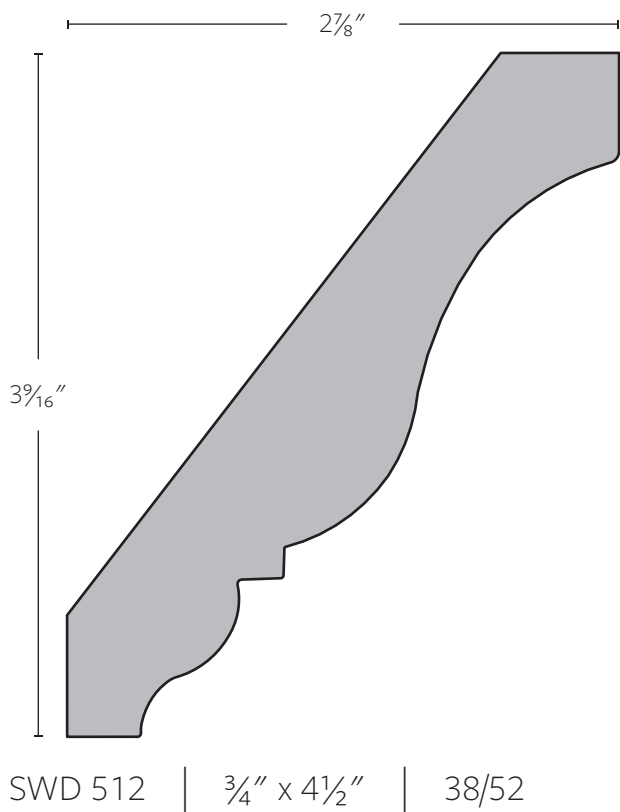
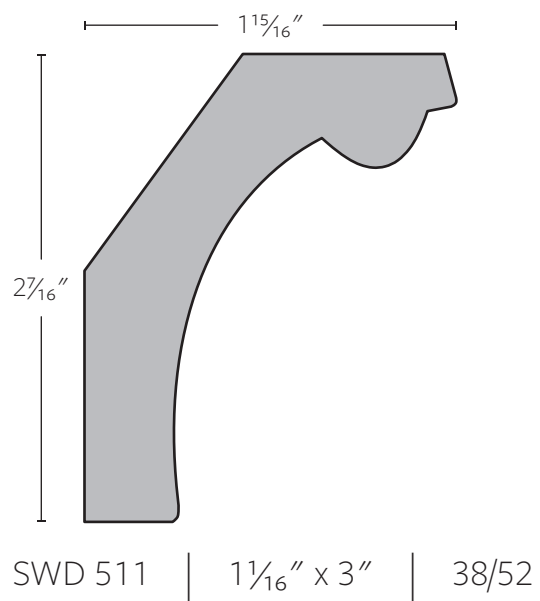
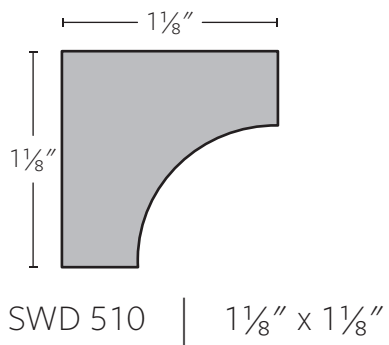

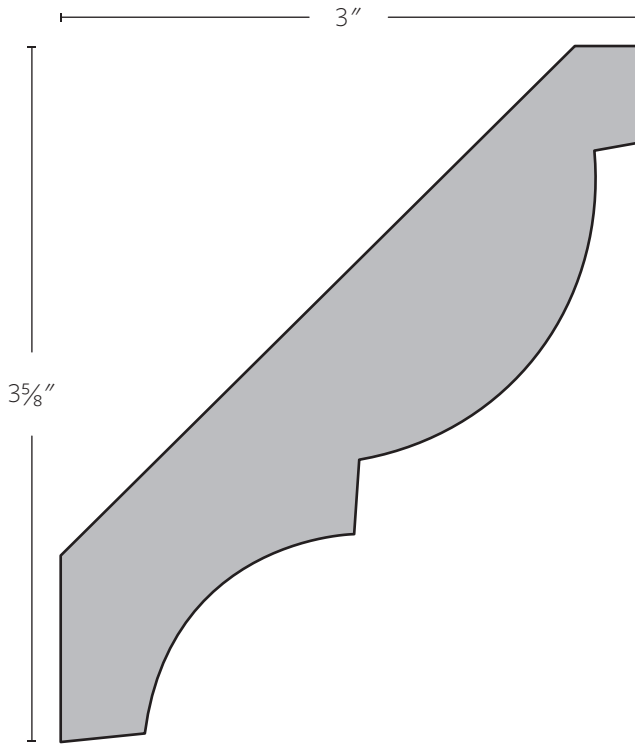

SWD 514 | 1" x 4 5/8" | 45/45

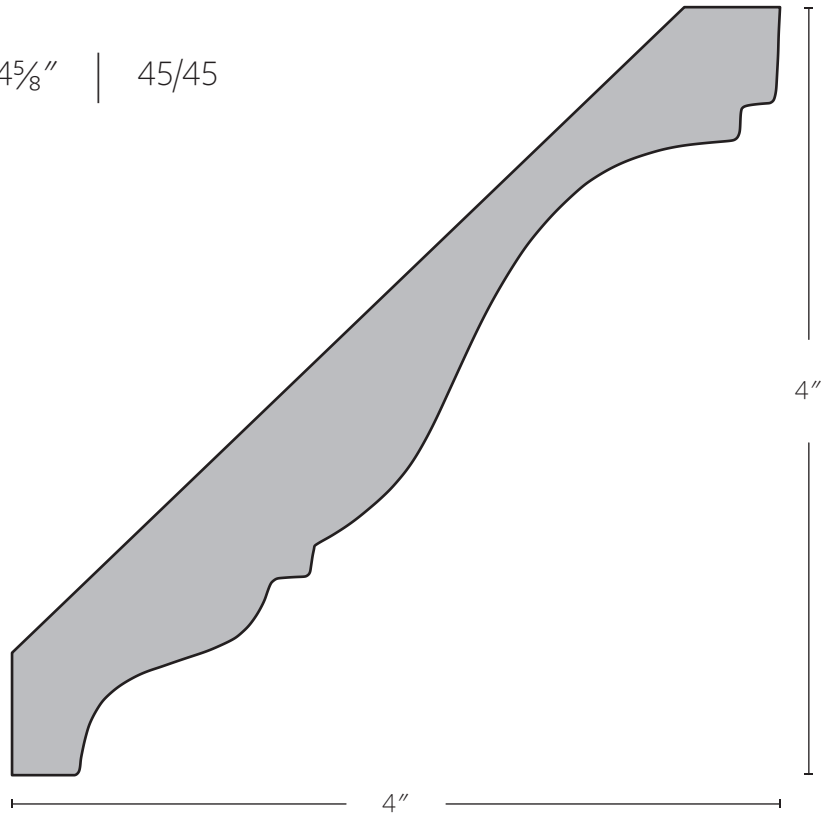

SWD 515 | 3/4" x 5 5/8" | 45/45

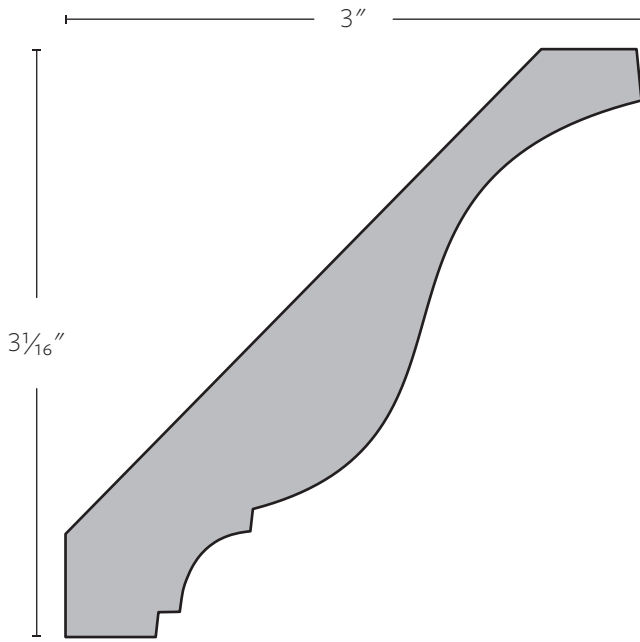

SWD 516 | $1\frac{3}{16}'' \times 4\frac{1}{4}''$ | 45/45

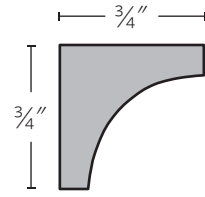

SWD 517 | $\frac{3}{4}'' \times \frac{3}{4}''$

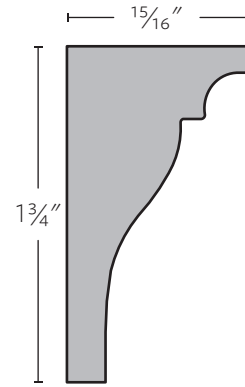

SWD 518 | $\frac{15}{16}'' \times 1\frac{3}{4}''$

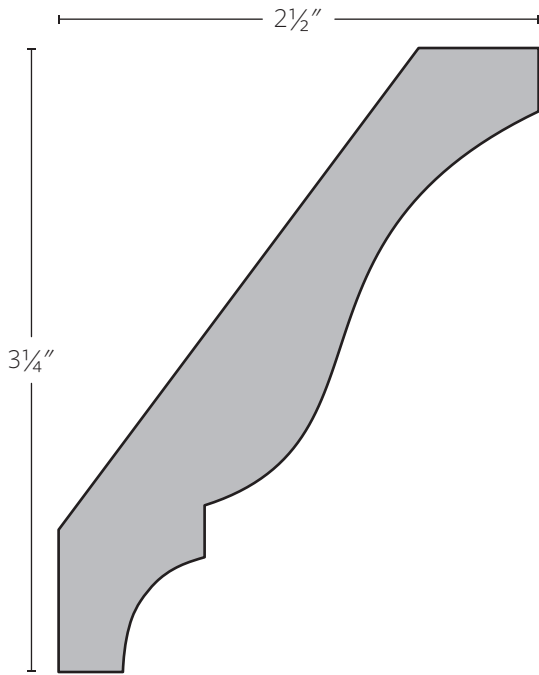

SWD 519 | $\frac{3}{4}'' \times 4\frac{1}{8}''$ | 38/52

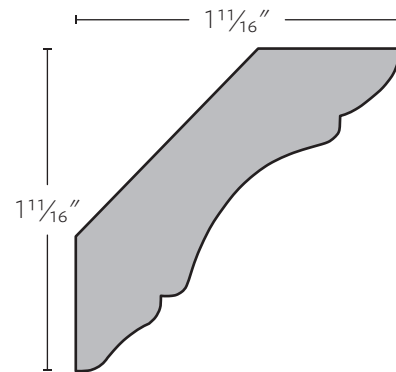

SWD 520 | $\frac{3}{4}'' \times 2\frac{3}{8}''$ | 45/45

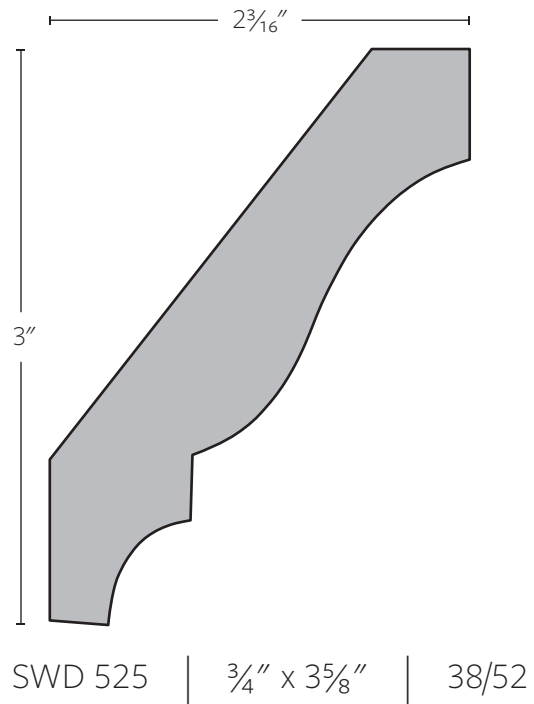
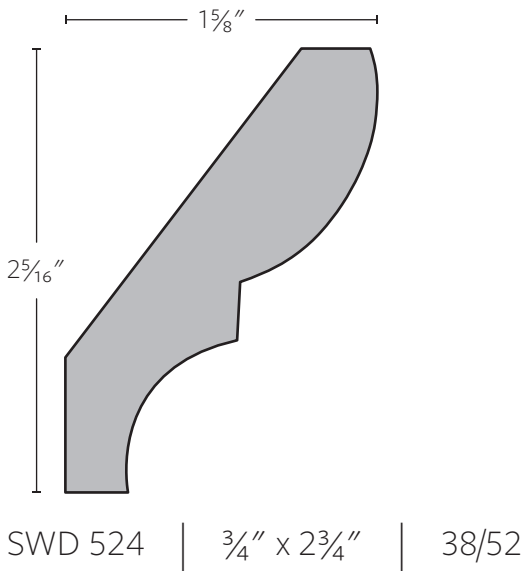
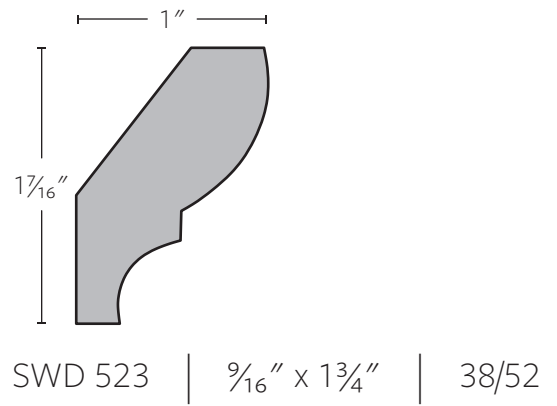
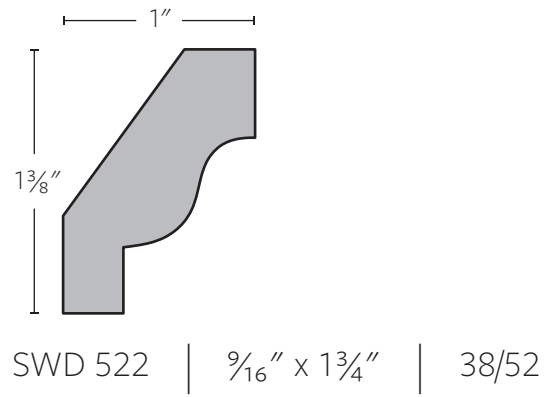
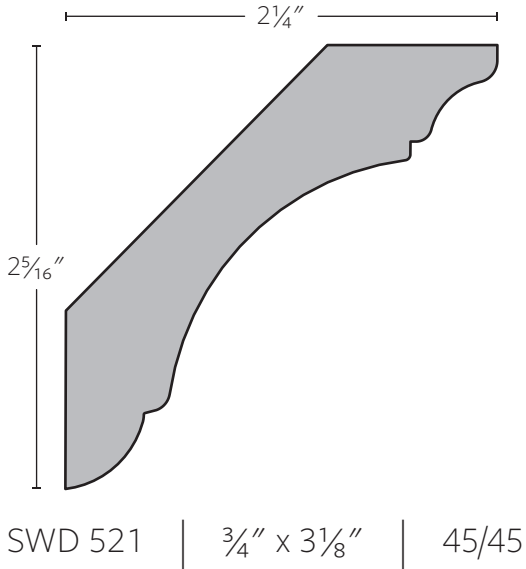

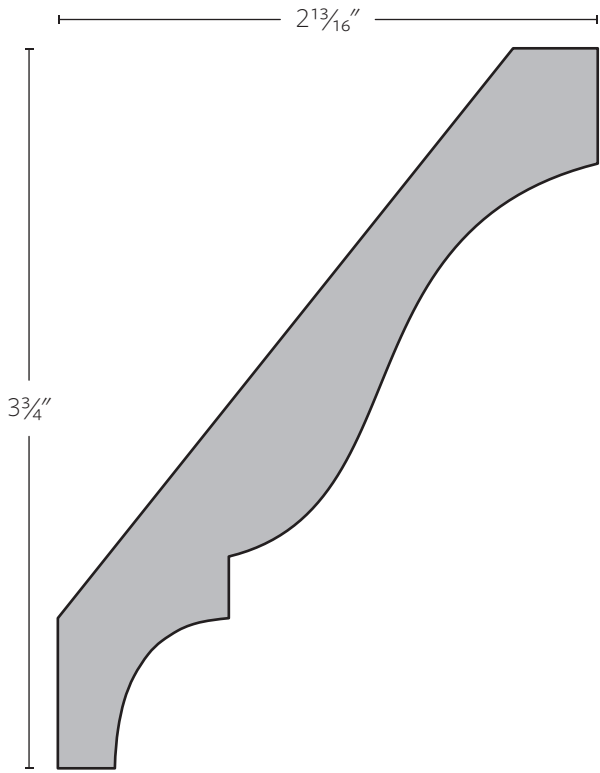

SWD 526 | $\frac{3}{4}$ " x $4\frac{5}{8}$ " | 38/52

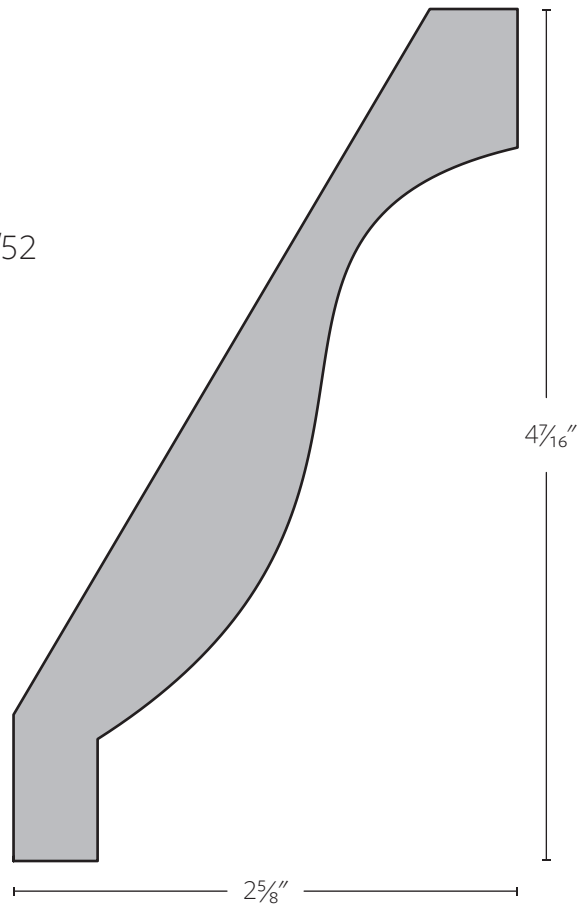

SWD 527 | $\frac{3}{4}$ " x $5\frac{1}{4}$ " | 30/60

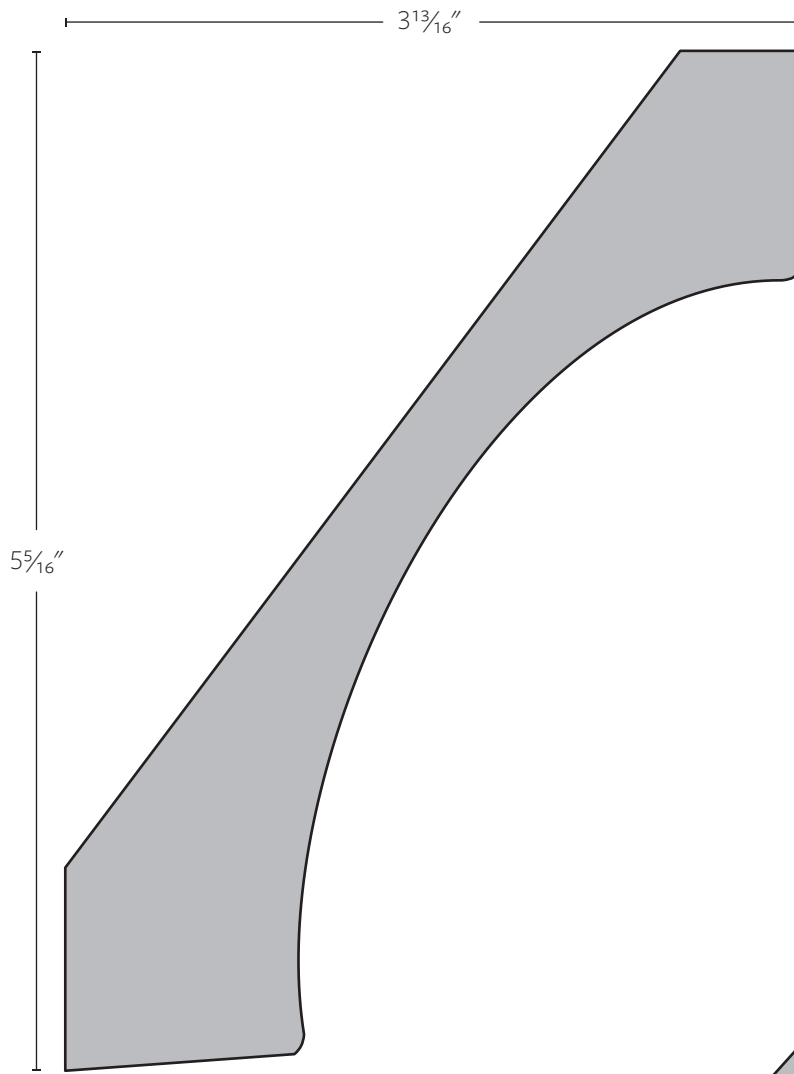

SWD 528 | 1 5/8" x 6 1/2" | 38/52
This profile requires an added setup charge.

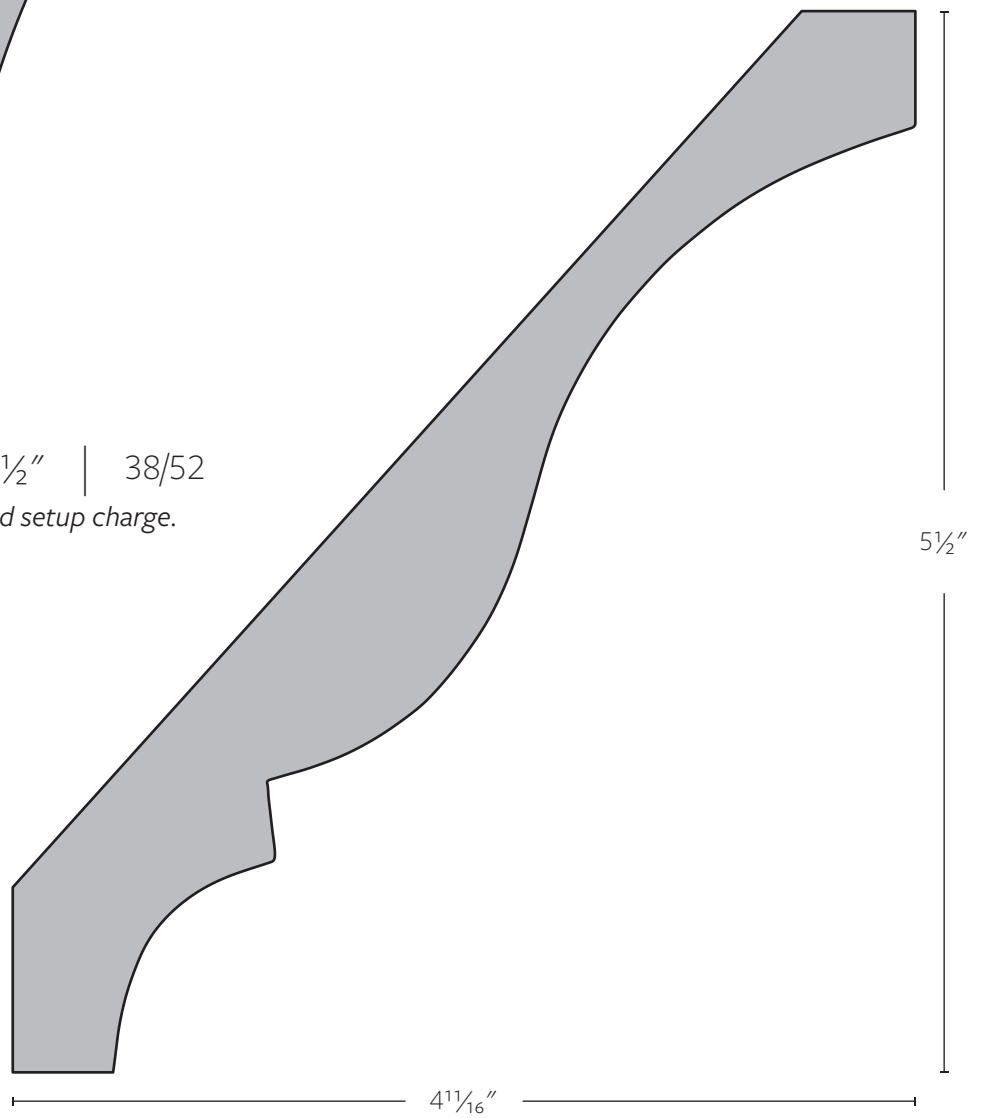

SWD 529 | 1" x 7 1/4" | 38/52

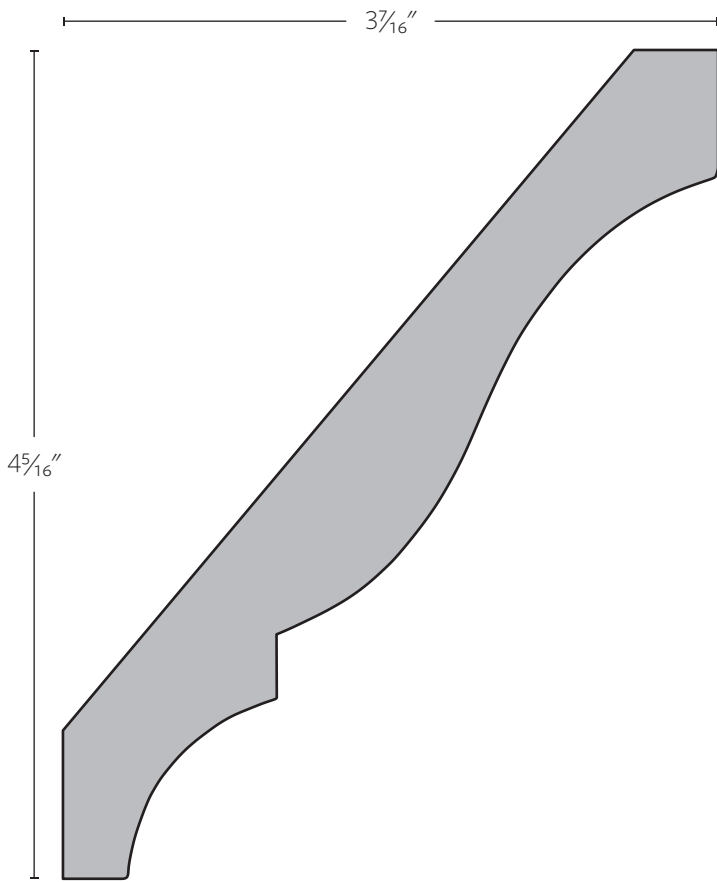

SWD 530 | 3/4" x 5 1/2" | 38/52

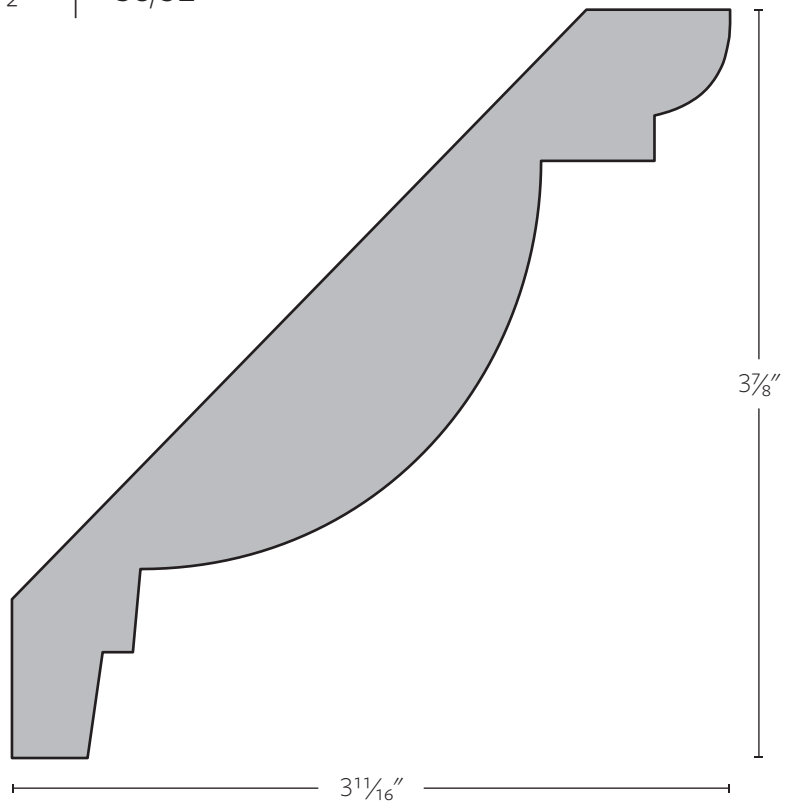

SWD 531 | 1" x 5 3/8" | 45/45

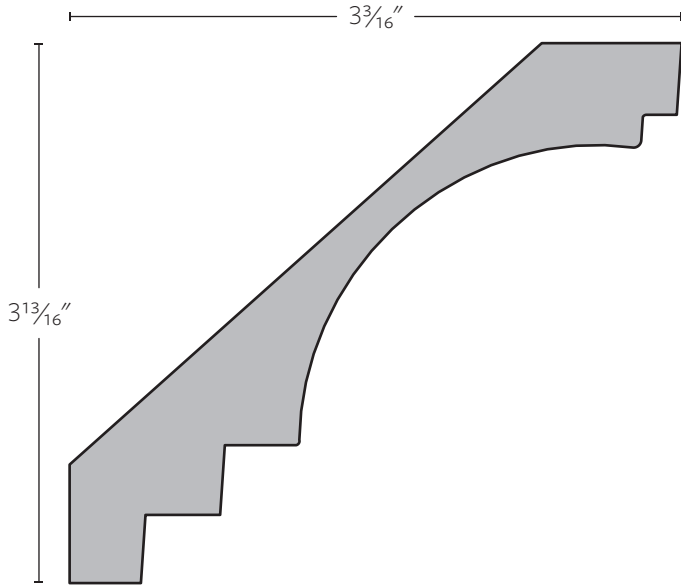

SWD 532 | $\frac{3}{4}$ " x $4\frac{1}{4}$ " | 45/45

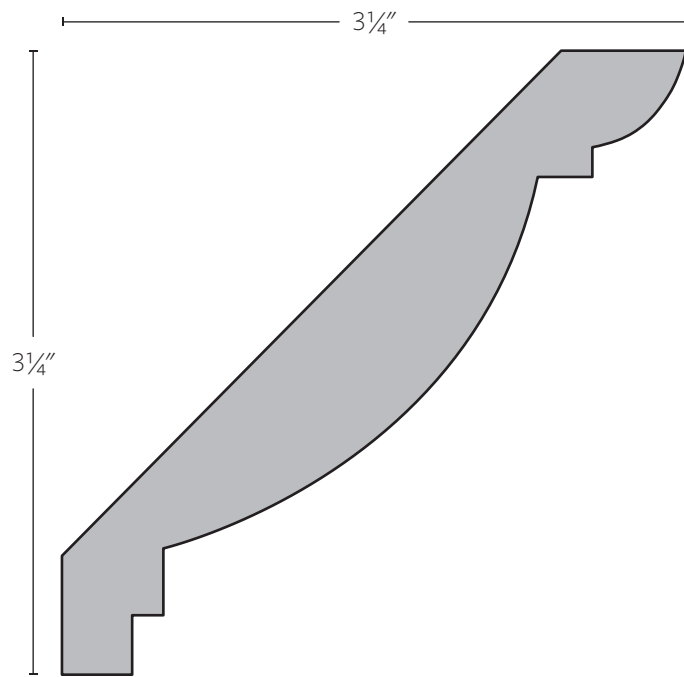

SWD 533 | $\frac{3}{4}$ " x $4\frac{1}{2}$ " | 45/45

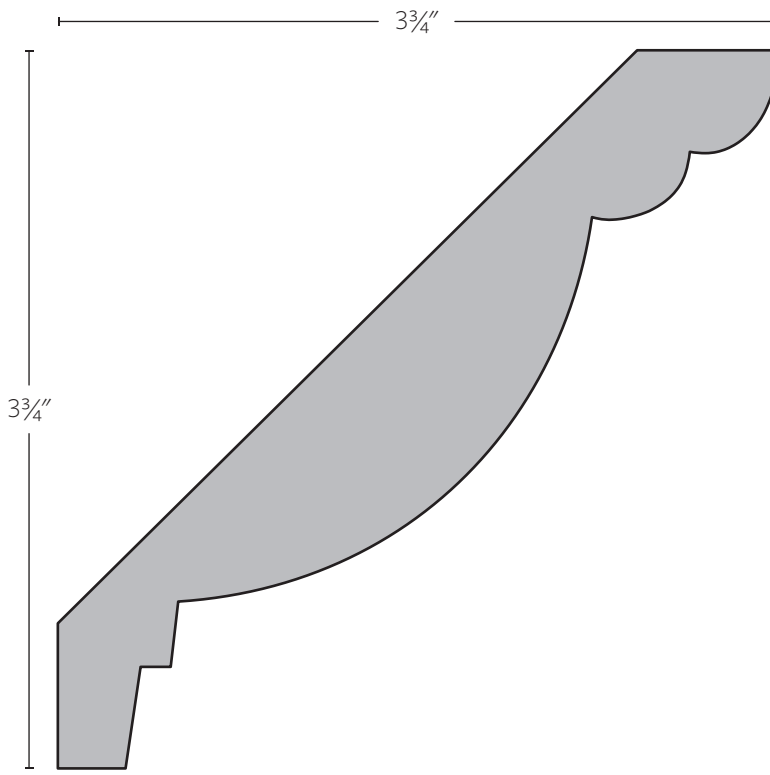

SWD 534 | 1" x 5 3/8" | 45/45

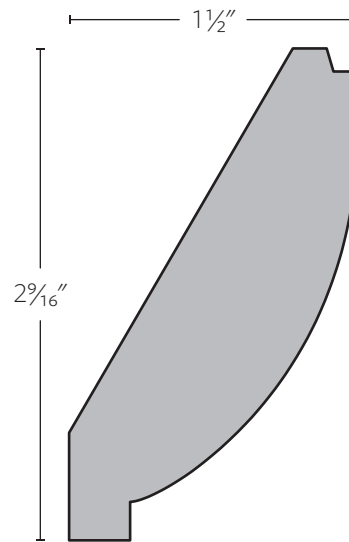

SWD 535 | 7/8" x 2 7/8" | 30/60

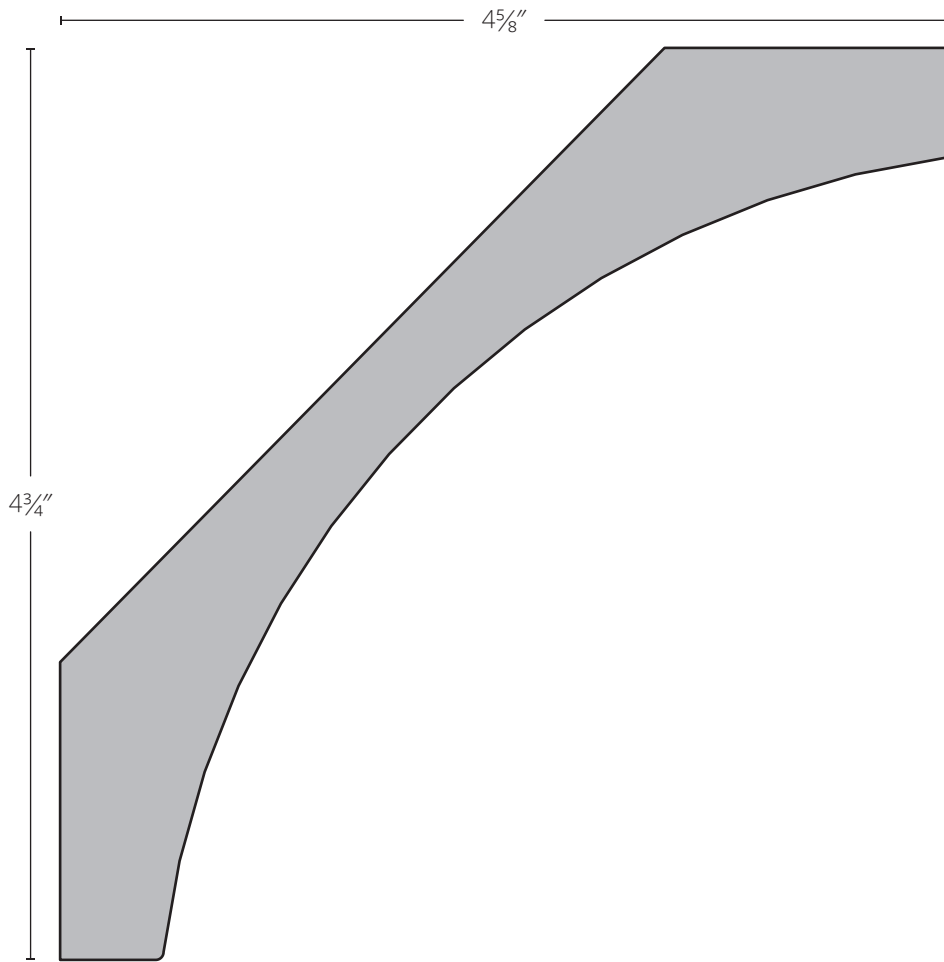

SWD 536 | 1 5/8" x 6 5/8" | 45/45
This profile requires an added setup charge.

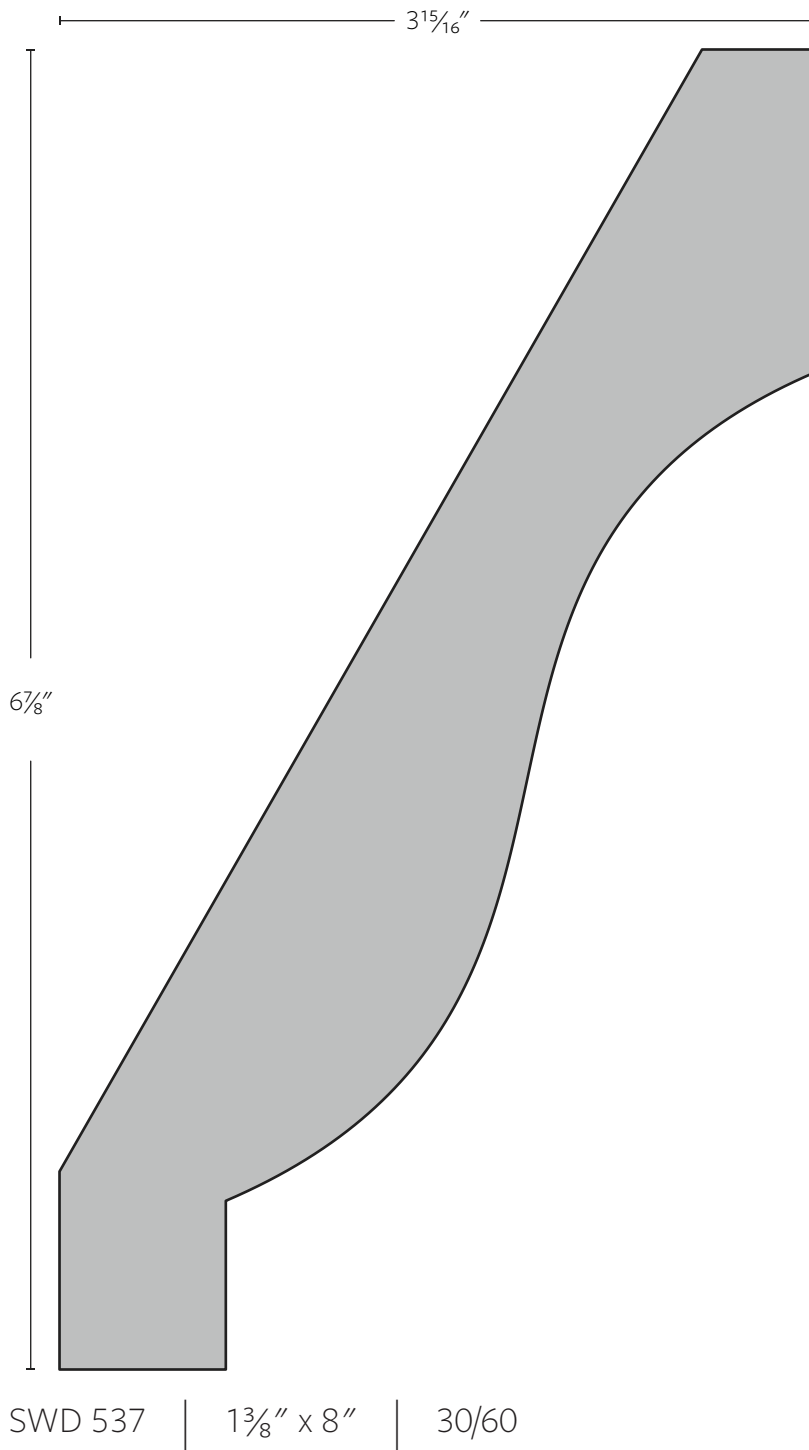

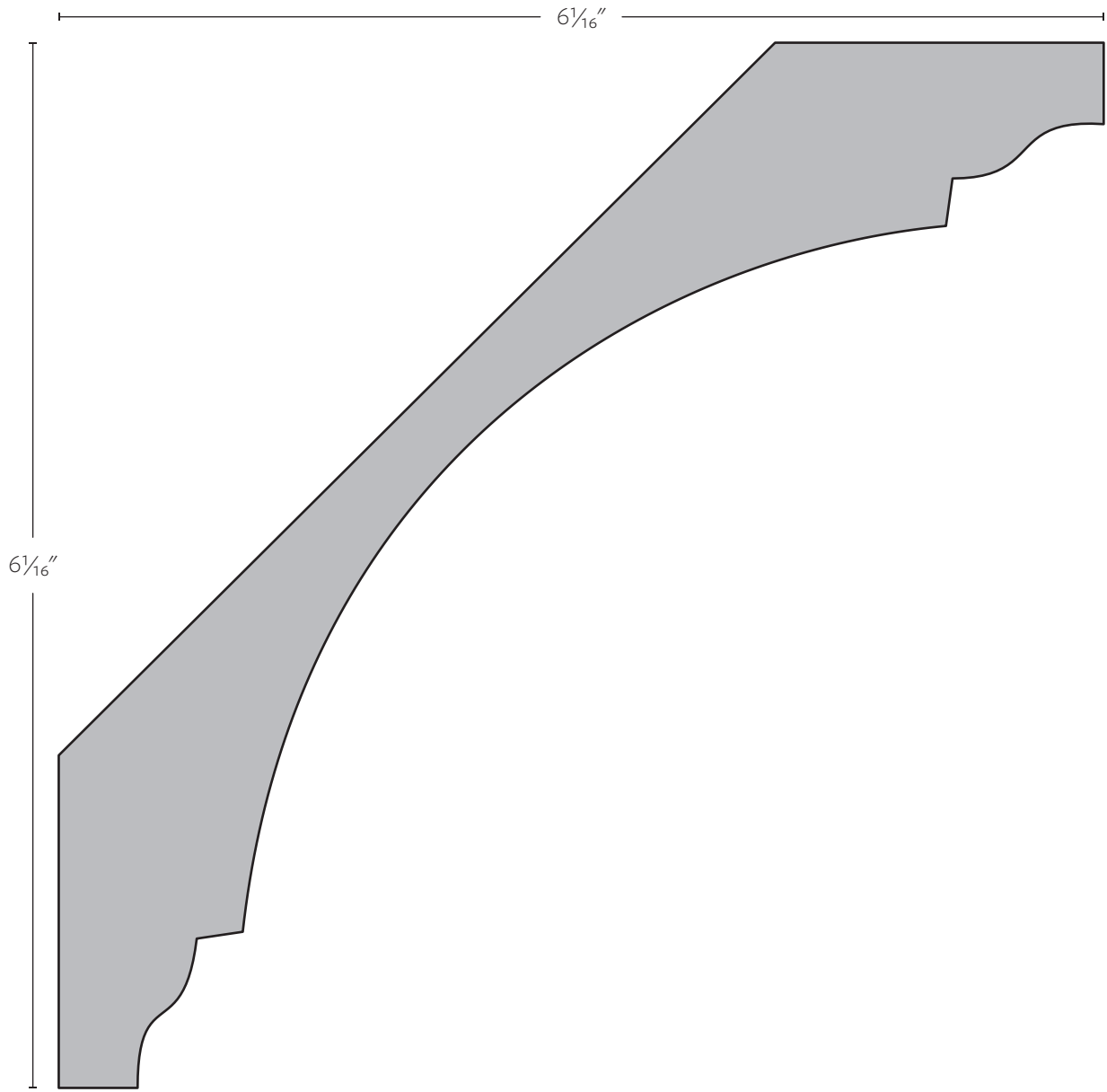

SWD 538 | $1\frac{5}{8}$ " x $8\frac{5}{8}$ " | 45/45

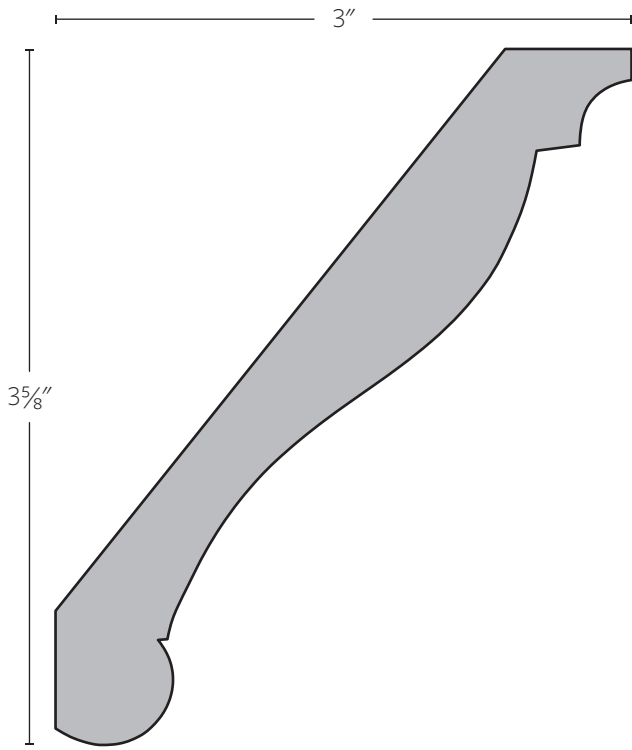

SWD 539 | $\frac{3}{4}'' \times 4\frac{1}{2}''$ | 38/52

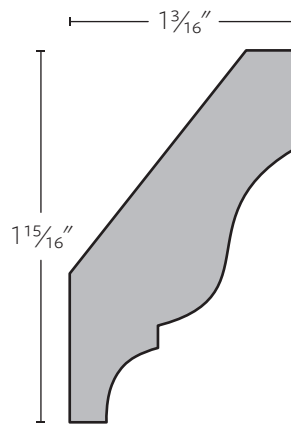

SWD 540 | $\frac{3}{4}'' \times 2\frac{1}{4}''$ | 38/52

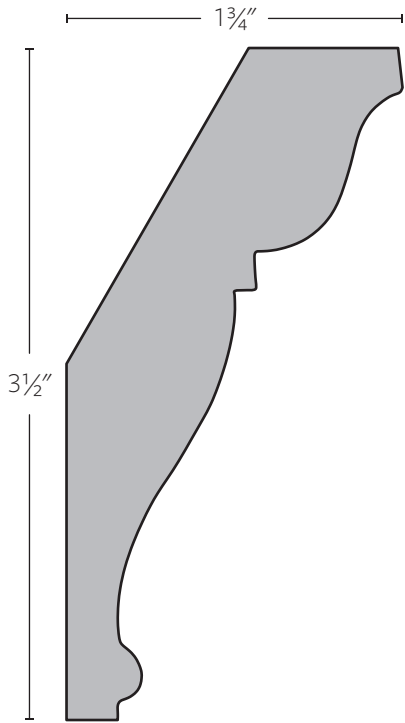

SWD 541 | $1\frac{3}{16}'' \times 3\frac{7}{8}''$ | 30/60

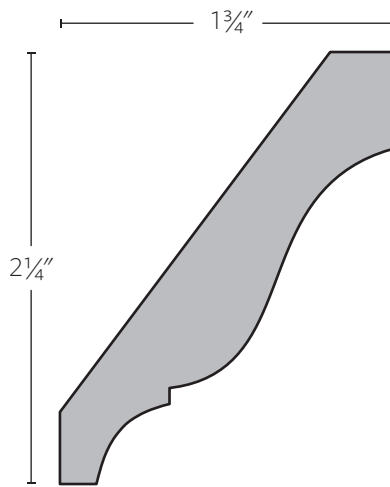

SWD 542 | $\frac{9}{16}'' \times 2\frac{3}{4}''$ | 38/52

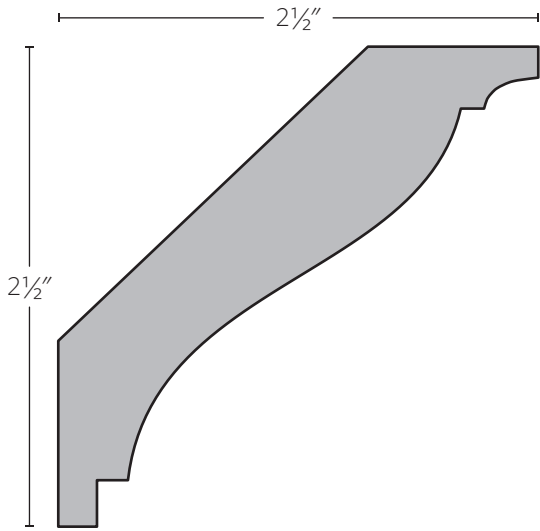

SWD 543 | $\frac{3}{4}'' \times 3\frac{1}{2}''$ | 45/45

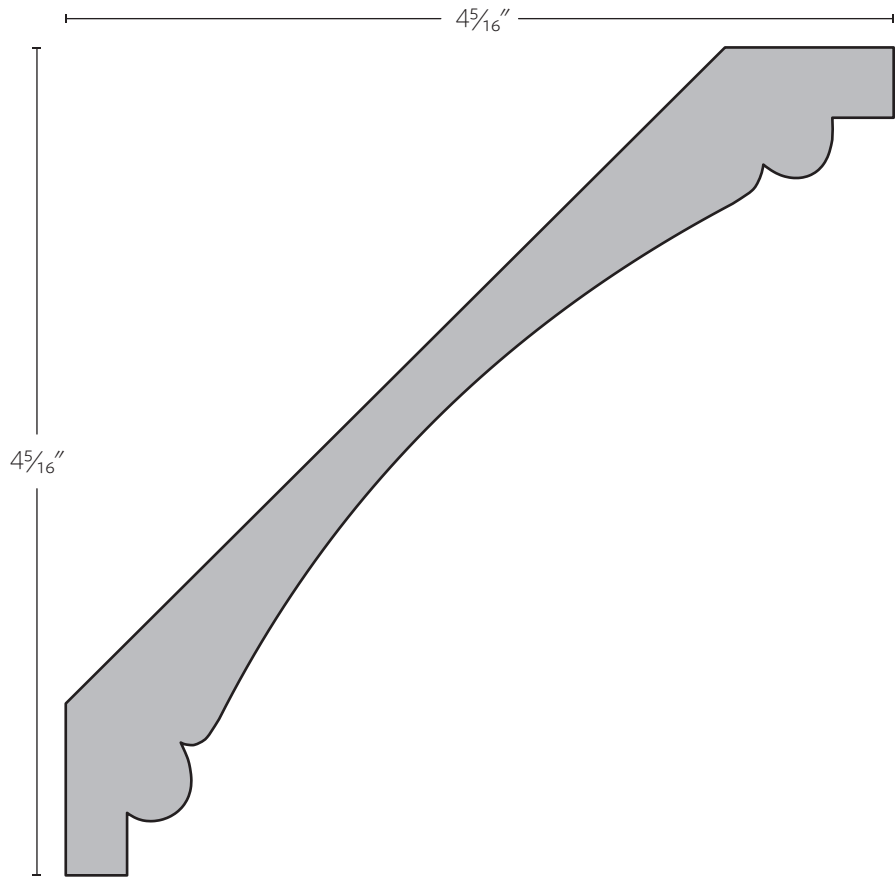

SWD 544 | $\frac{7}{8}'' \times 6''$ | 45/45

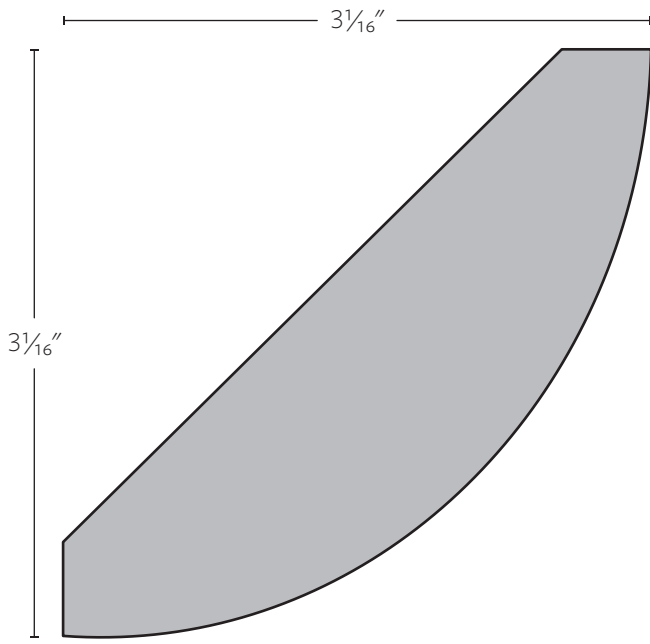

SWD 545 | $1\frac{1}{4}$ " x $4\frac{1}{4}$ " | 45/45

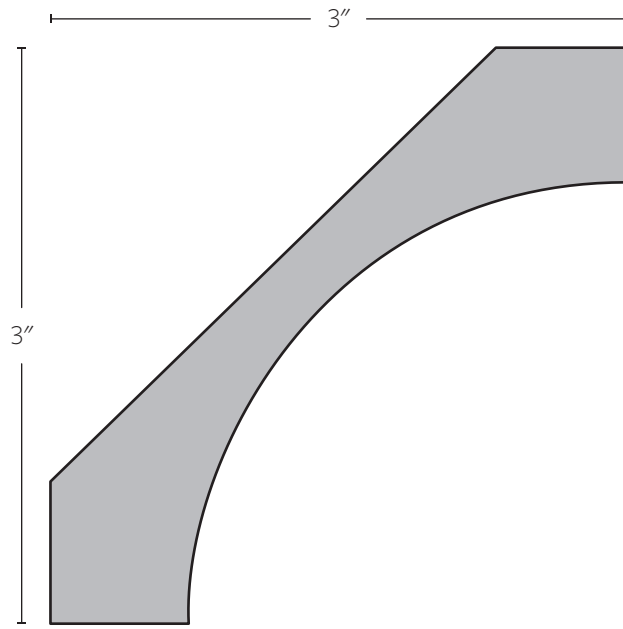

SWD 546 | 1" x $4\frac{1}{4}$ " | 45/45

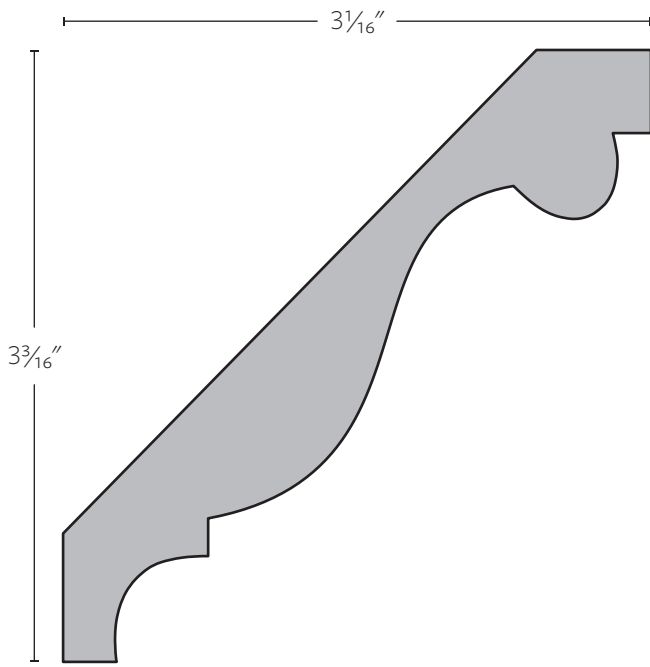

SWD 547 | 3/4" x 4 3/8" | 45/45

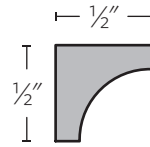

SWD 548 | 1/2" x 1/2"

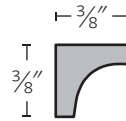

SWD 549 | 3/8" x 3/8"

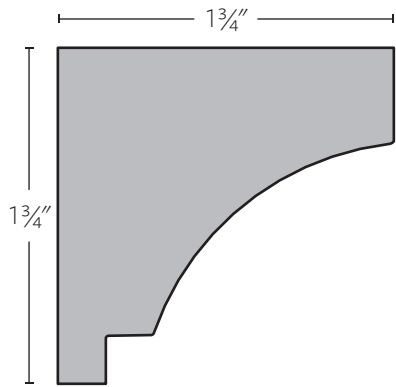

SWD 550 | 1 3/4" x 1 3/4"

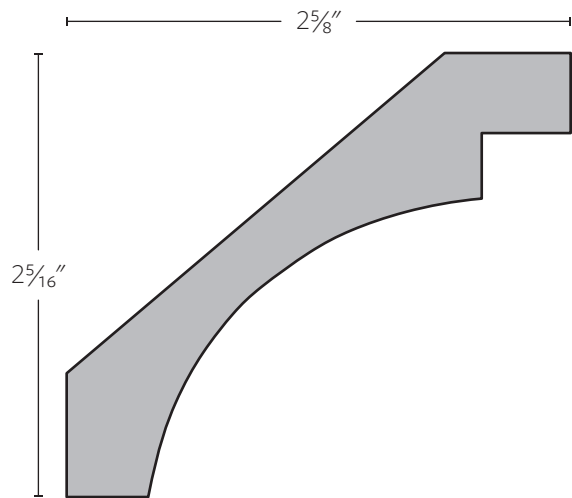

SWD 551 | 3/4" x 3 9/16" | 45/45

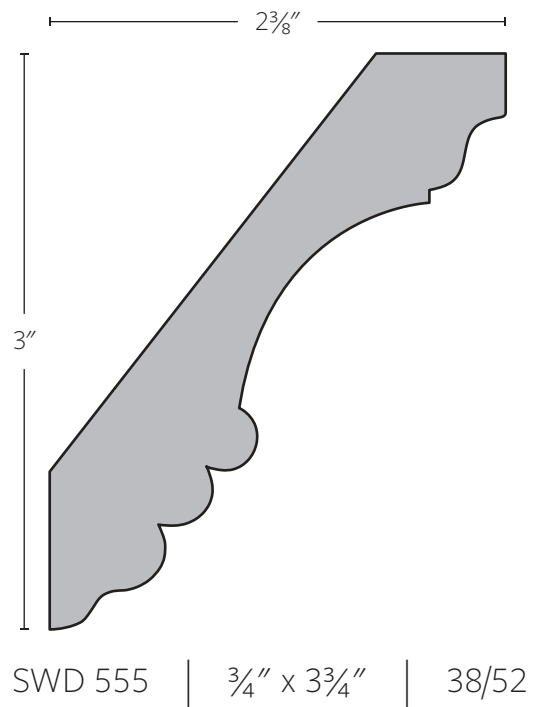
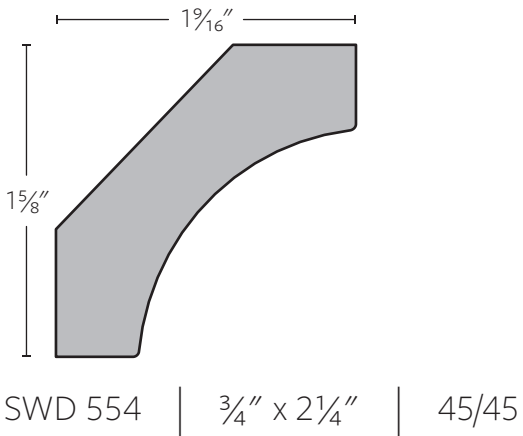
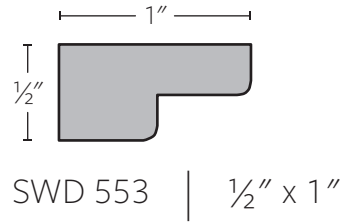
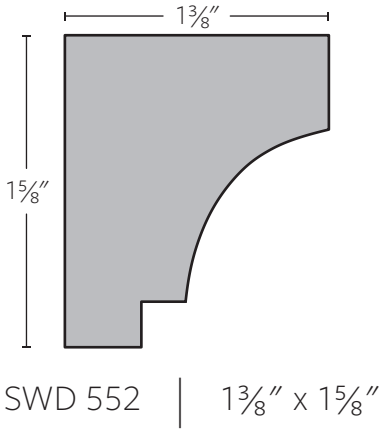

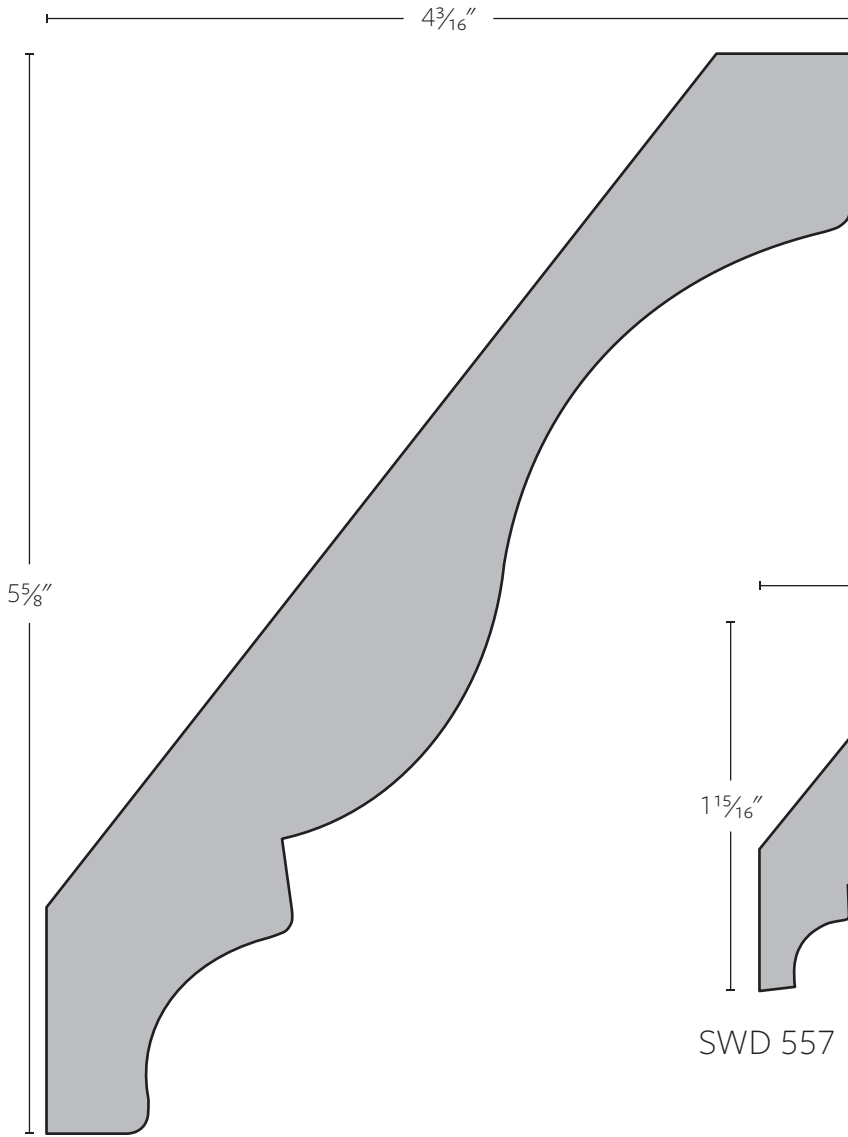

SWD 556 | $1\frac{1}{16}$ " x 7" | 38/52

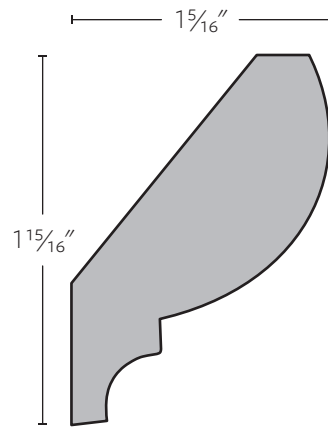

SWD 557 | $\frac{3}{4}$ " x $2\frac{5}{16}$ " | 38/52

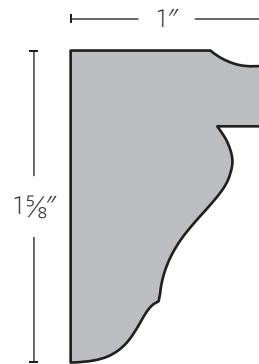

SWD 558 | $1\frac{3}{16}$ " x $1\frac{7}{8}$ " | 30/60

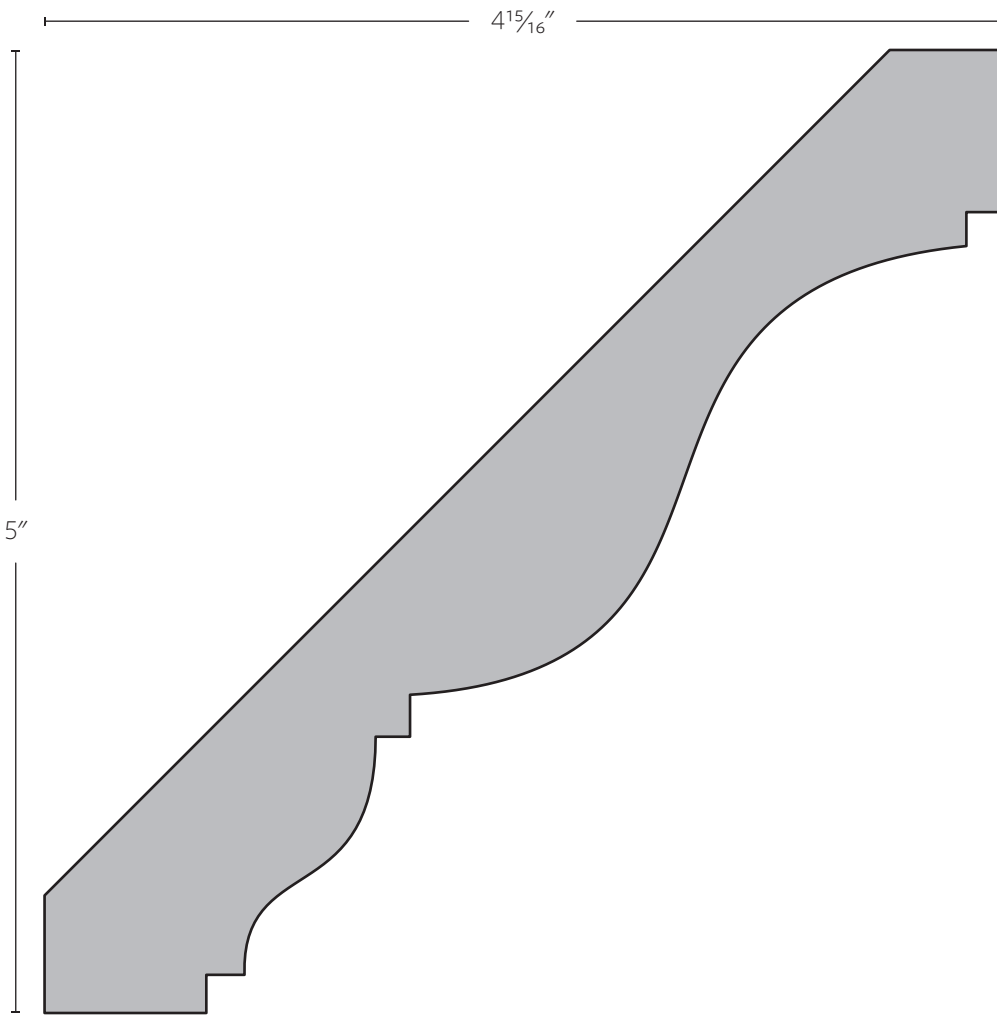

SWD 559 | $1\frac{1}{16}$ " x 7" | 45/45

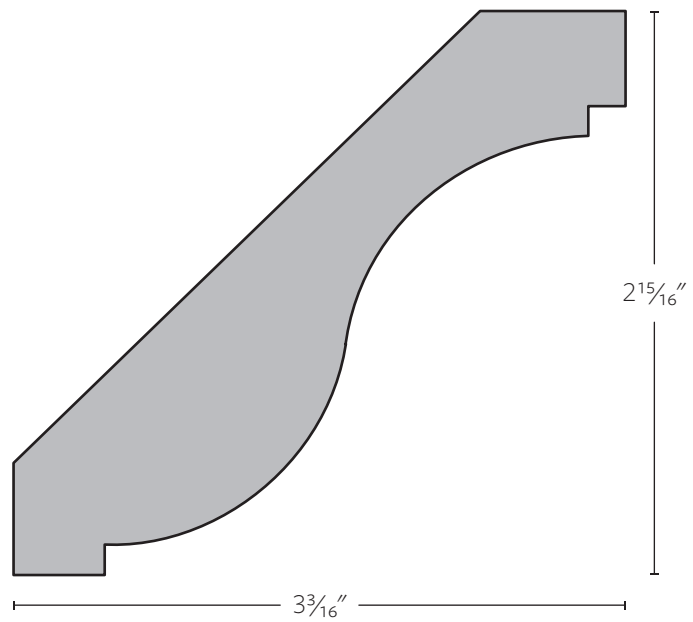

SWD 560 | 1" x $4\frac{5}{16}$ " | 45/45

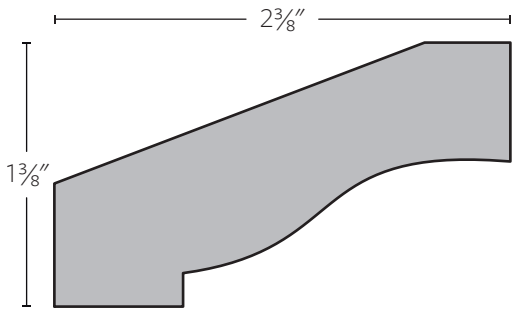

SWD 561 | $1\frac{3}{16}$ " x $2\frac{11}{16}$ " | 19/71

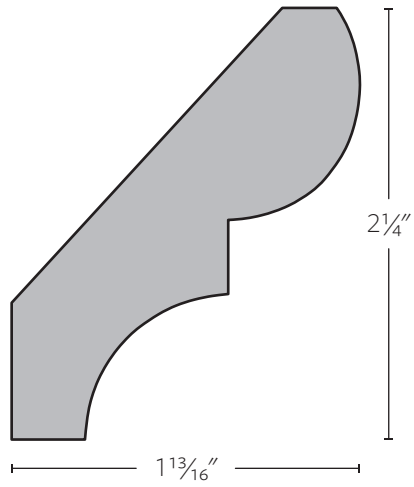

SWD 562 | $\frac{3}{4}$ " x $2\frac{13}{16}$ " | 45/45

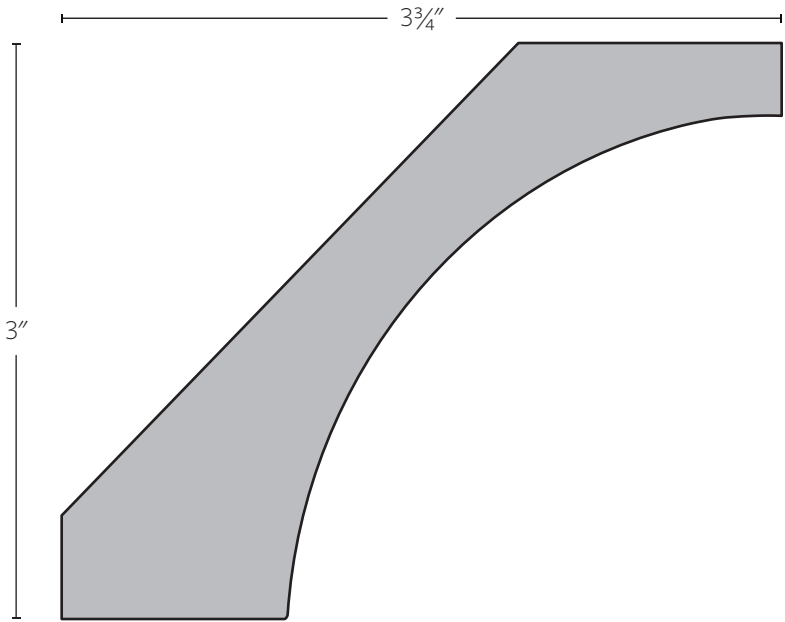

SWD 563 | $1\frac{1}{4}$ " x $4\frac{7}{8}$ " | 45/45

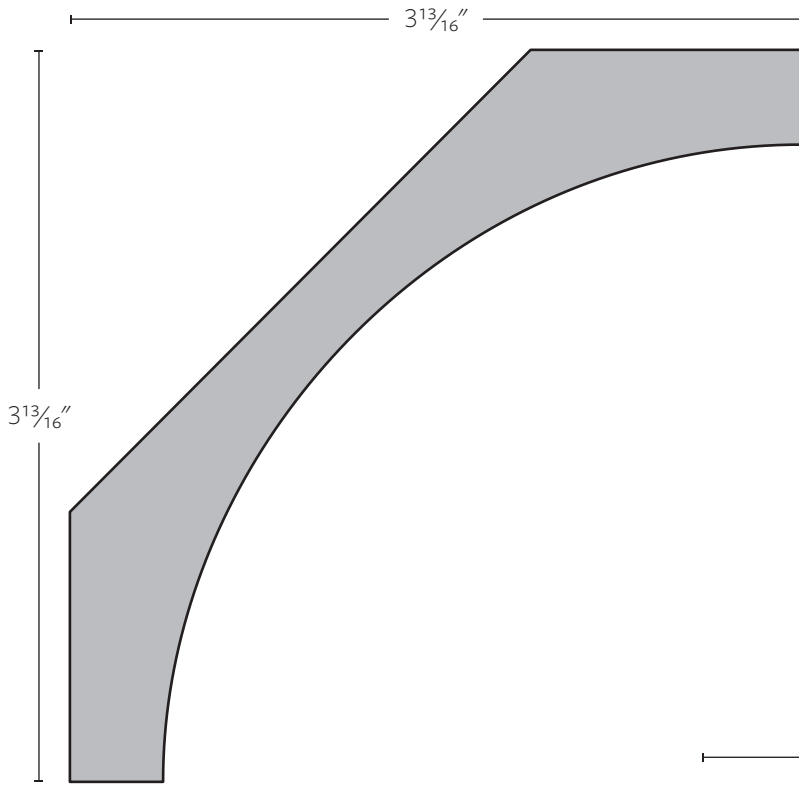

SWD 564 | $1\frac{3}{8}'' \times 5\frac{3}{8}''$ | 45/45
This profile requires an added setup charge.

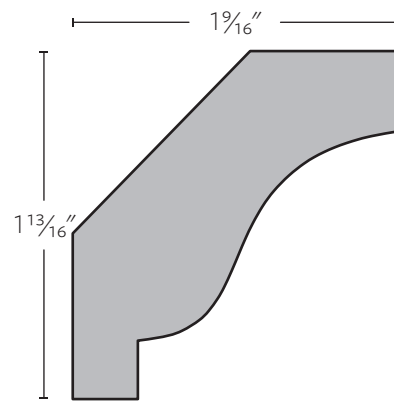

SWD 565 | $\frac{3}{4}'' \times 2\frac{3}{8}''$ | 45/45

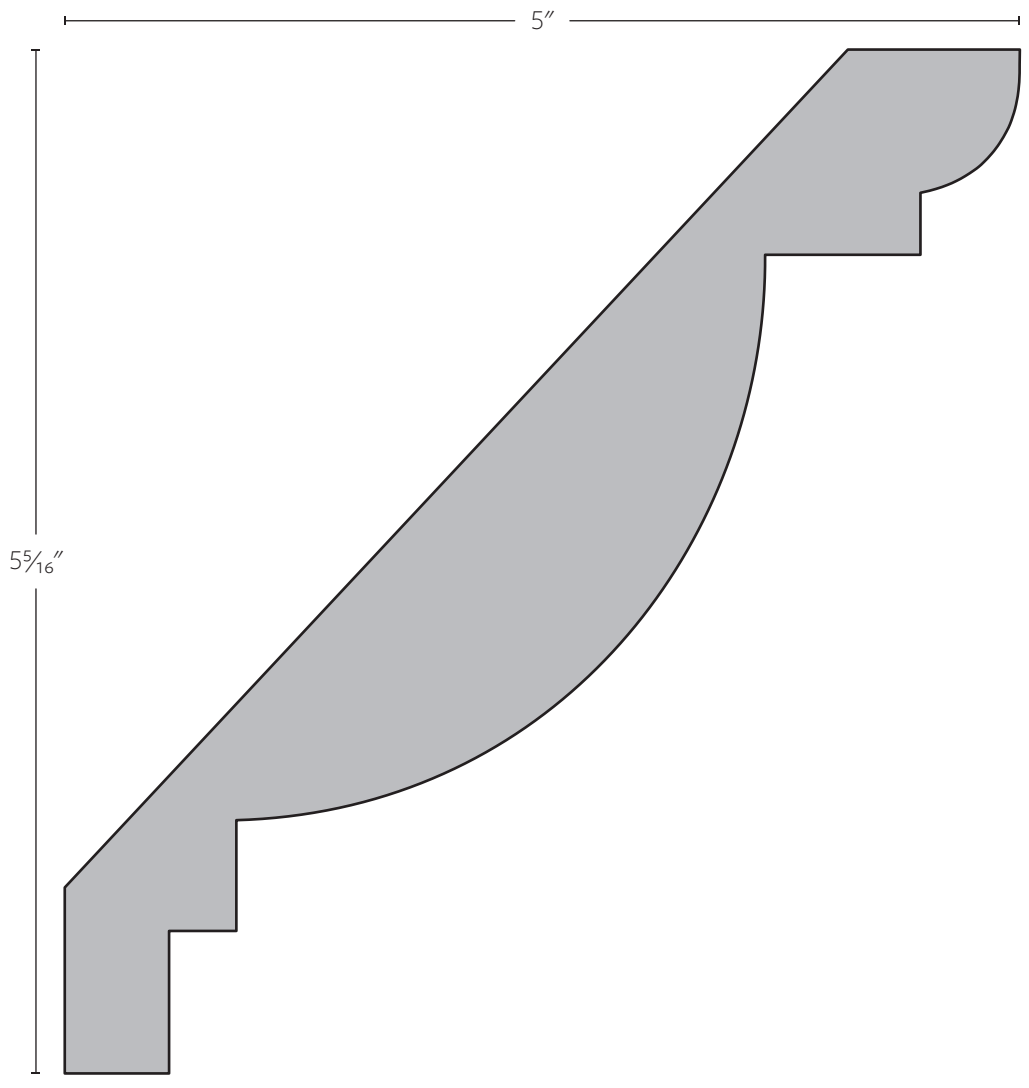

SWD 566 | 1 1/4" x 7 1/4" | 45/45

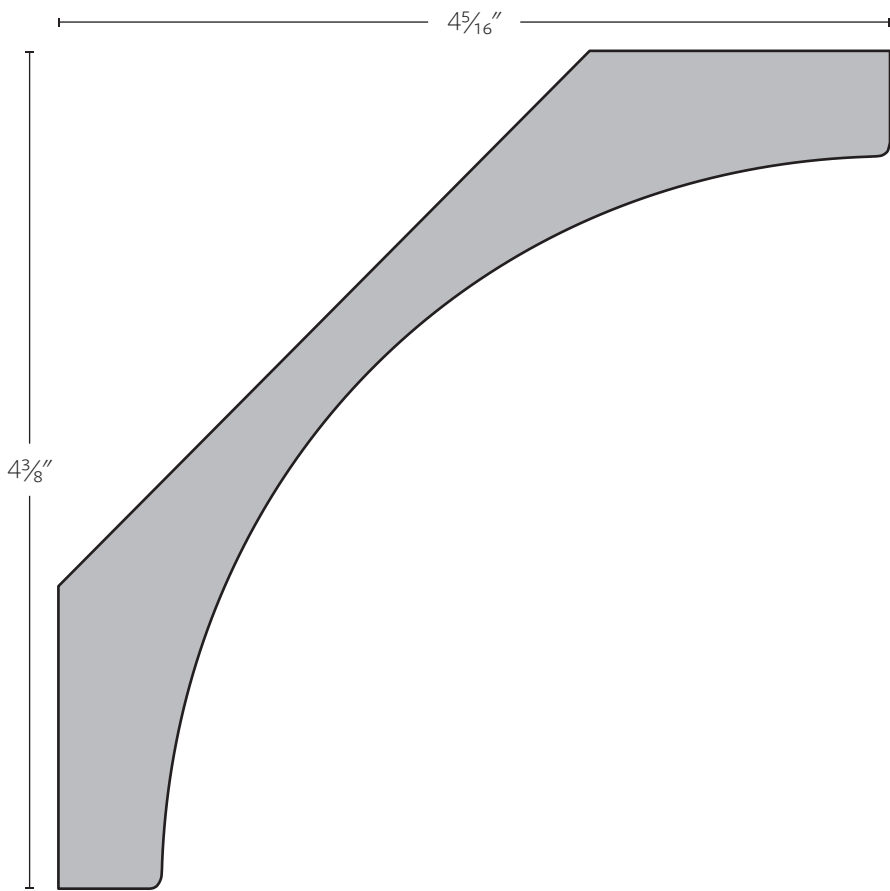

SWD 567 | 1 1/2" x 6 1/8" | 45/45
 This profile requires an added setup charge.

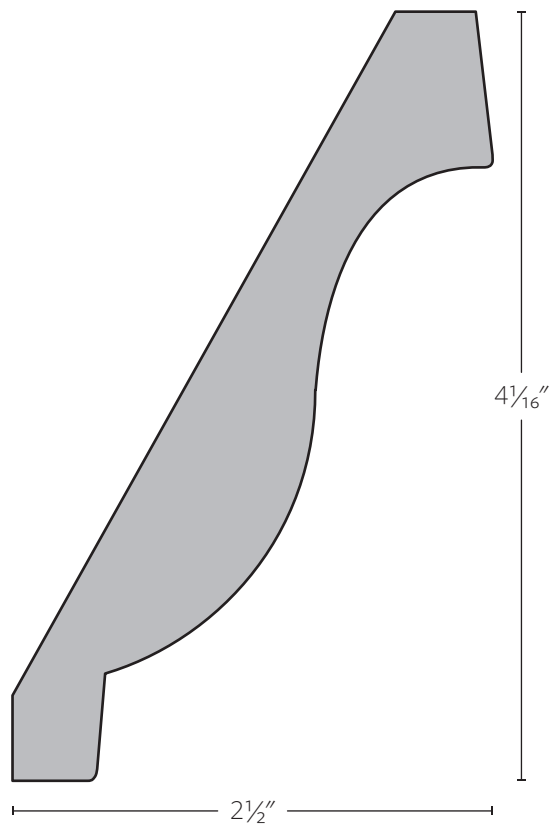

SWD 568 | 1 3/16" x 4 1/16" | 30/60

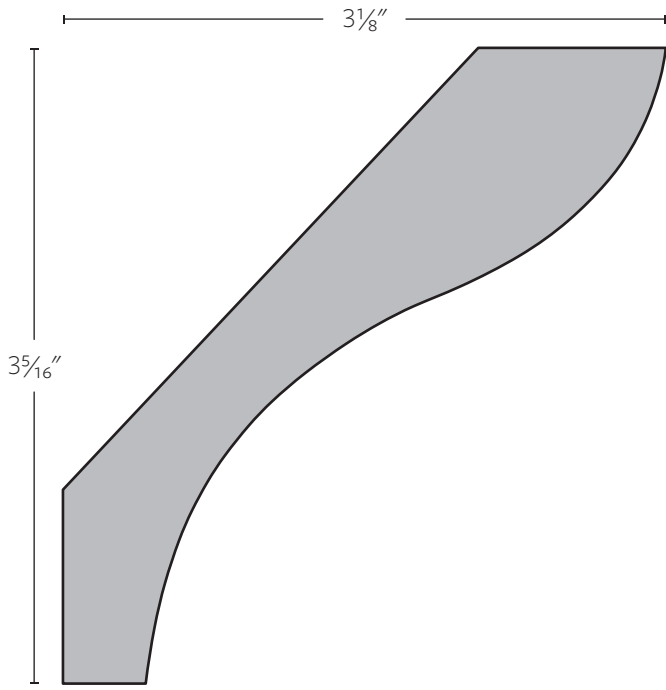

SWD 569 | 1" x 4½" | 45/45

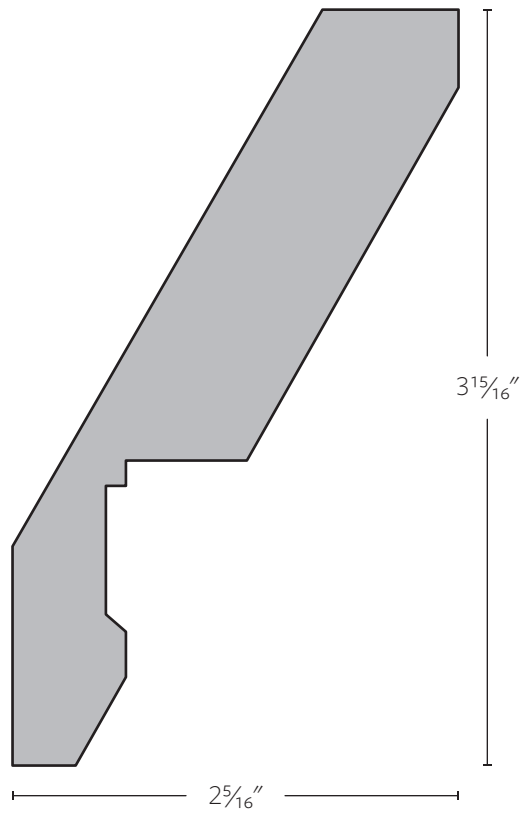

SWD 570 | 1⅜" x 4⅝" | 30/60

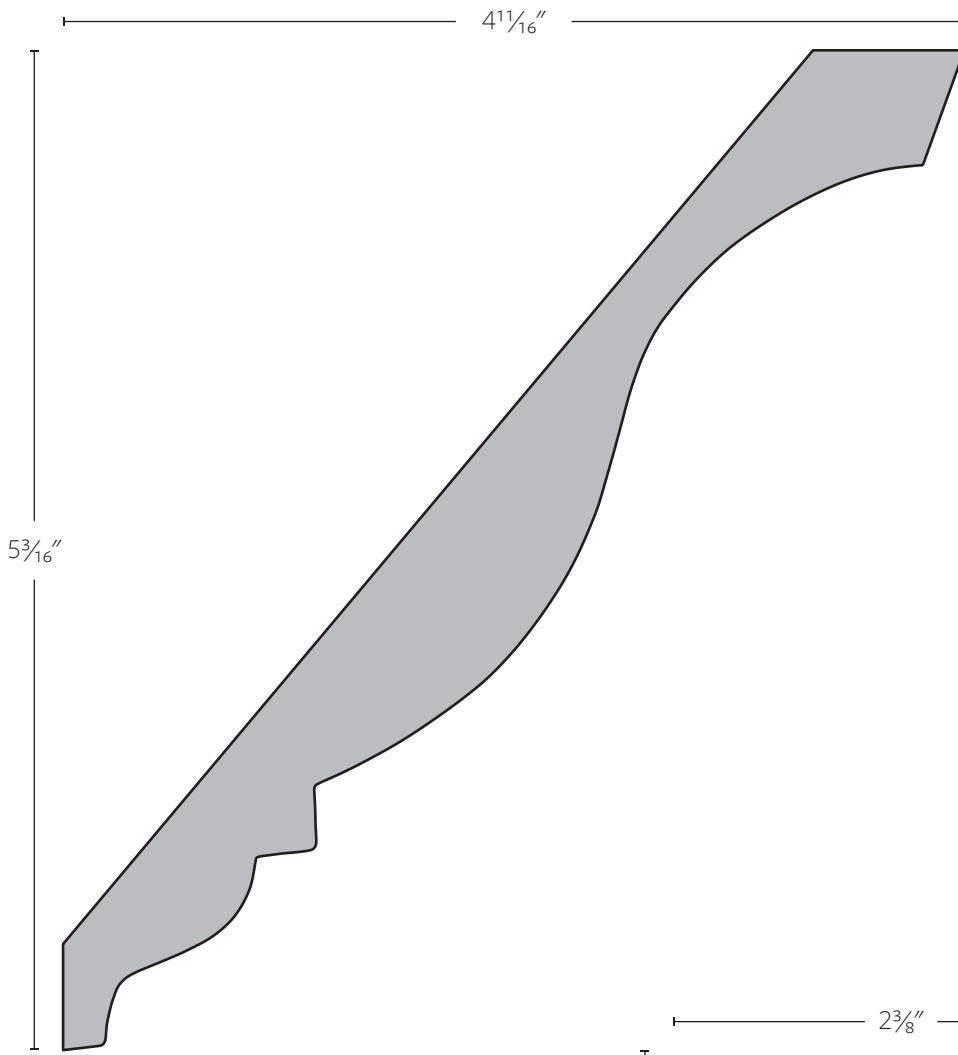

SWD 571 | $1\frac{3}{16}$ " x 7" | 38/52

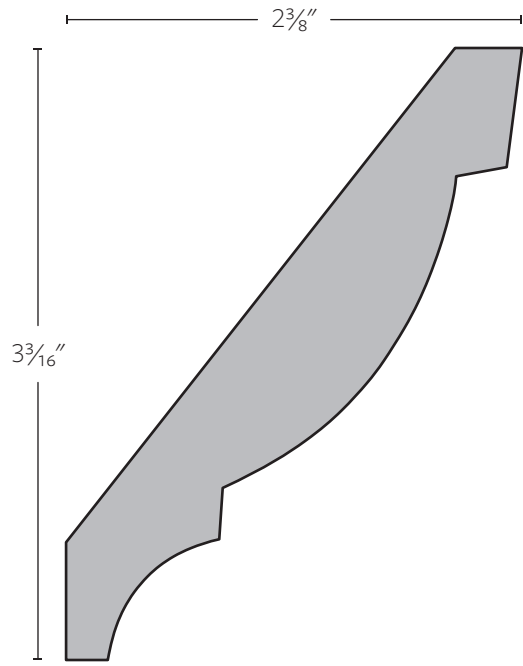

SWD 572 | $\frac{3}{4}$ " x $3\frac{15}{16}$ " | 38/52

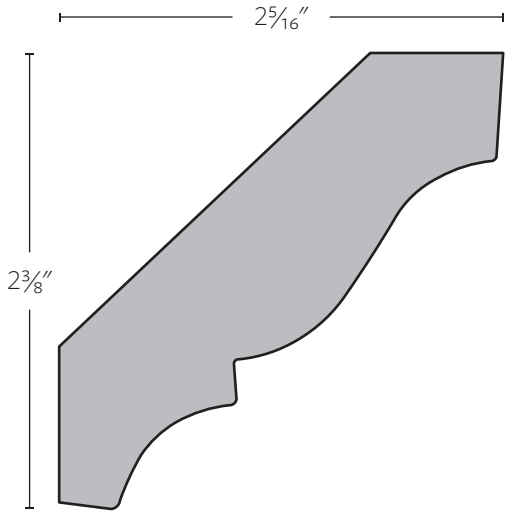

SWD 573 | $\frac{3}{4}'' \times 3\frac{1}{4}''$ | 45/45

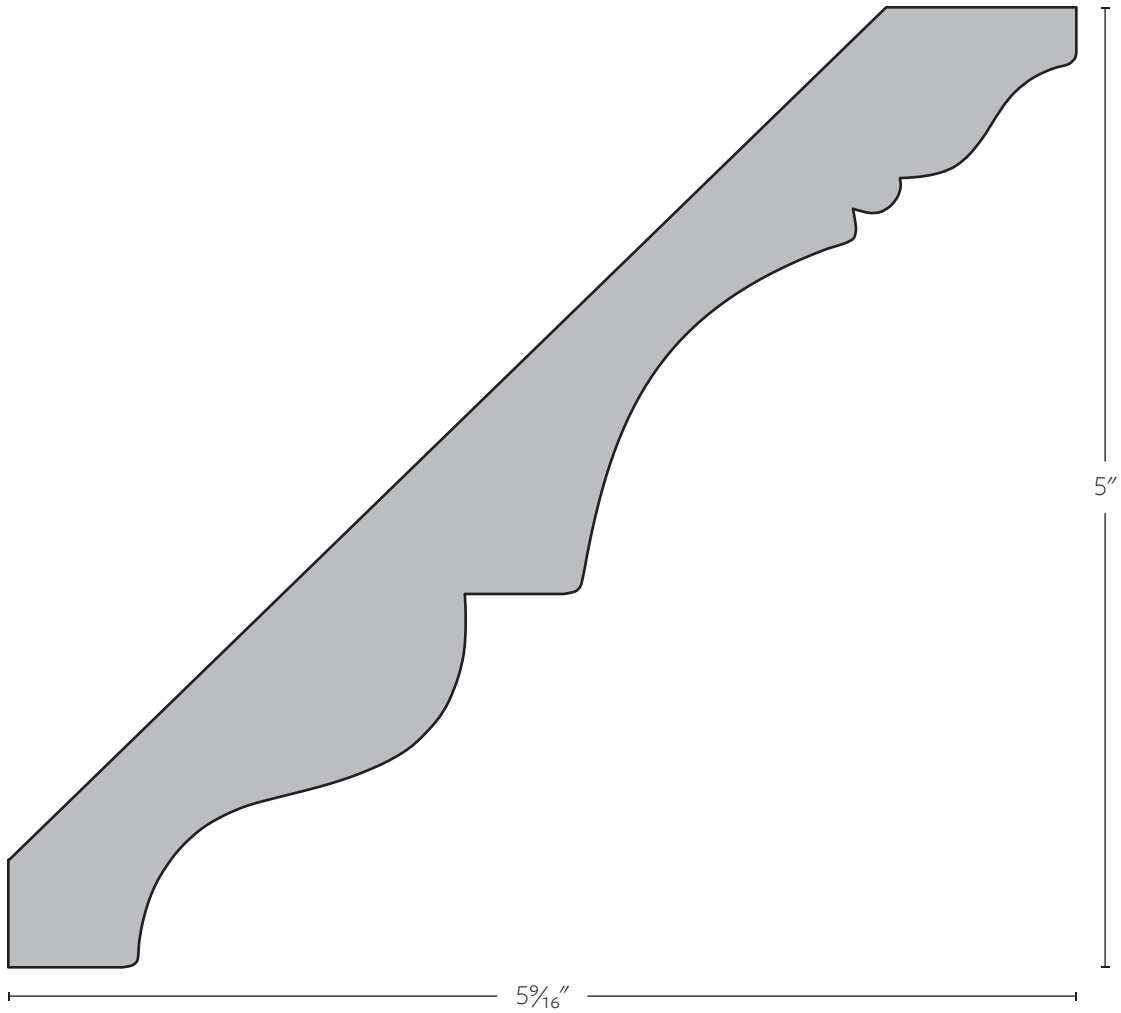

SWD 574 | $1\frac{1}{16}'' \times 7\frac{3}{8}''$ | 45/45

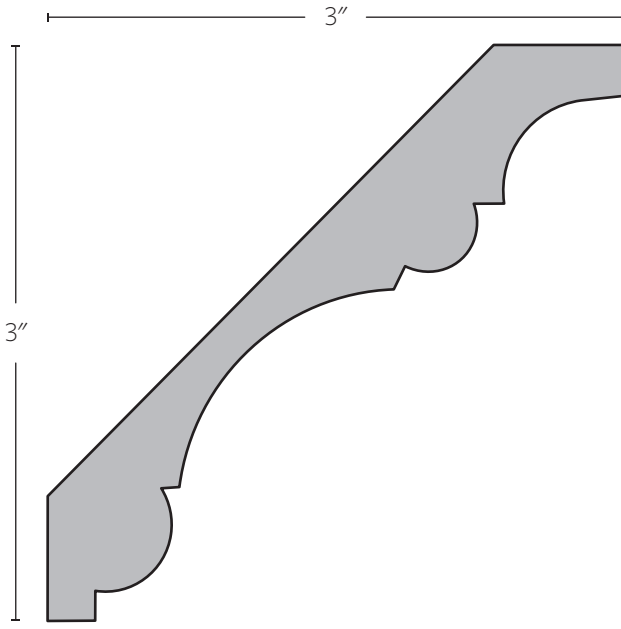

SWD 575 | $1\frac{1}{16}'' \times 4\frac{1}{4}''$ | 45/45

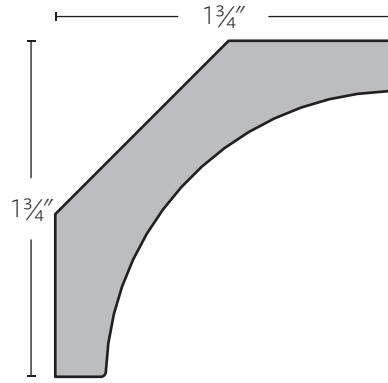

SWD 576 | $\frac{3}{4}'' \times 2\frac{1}{2}''$ | 45/45

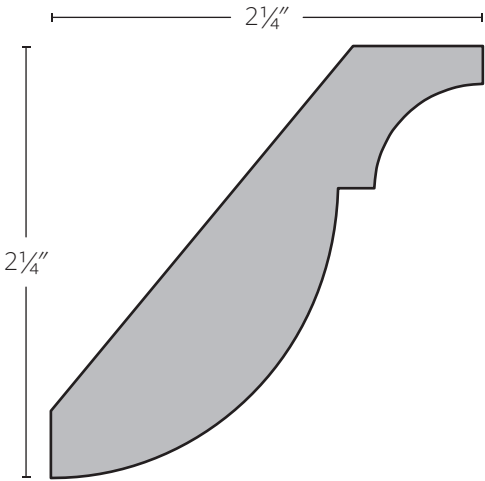

SWD 577 | $\frac{3}{4}'' \times 3\frac{1}{4}''$ | 38/52

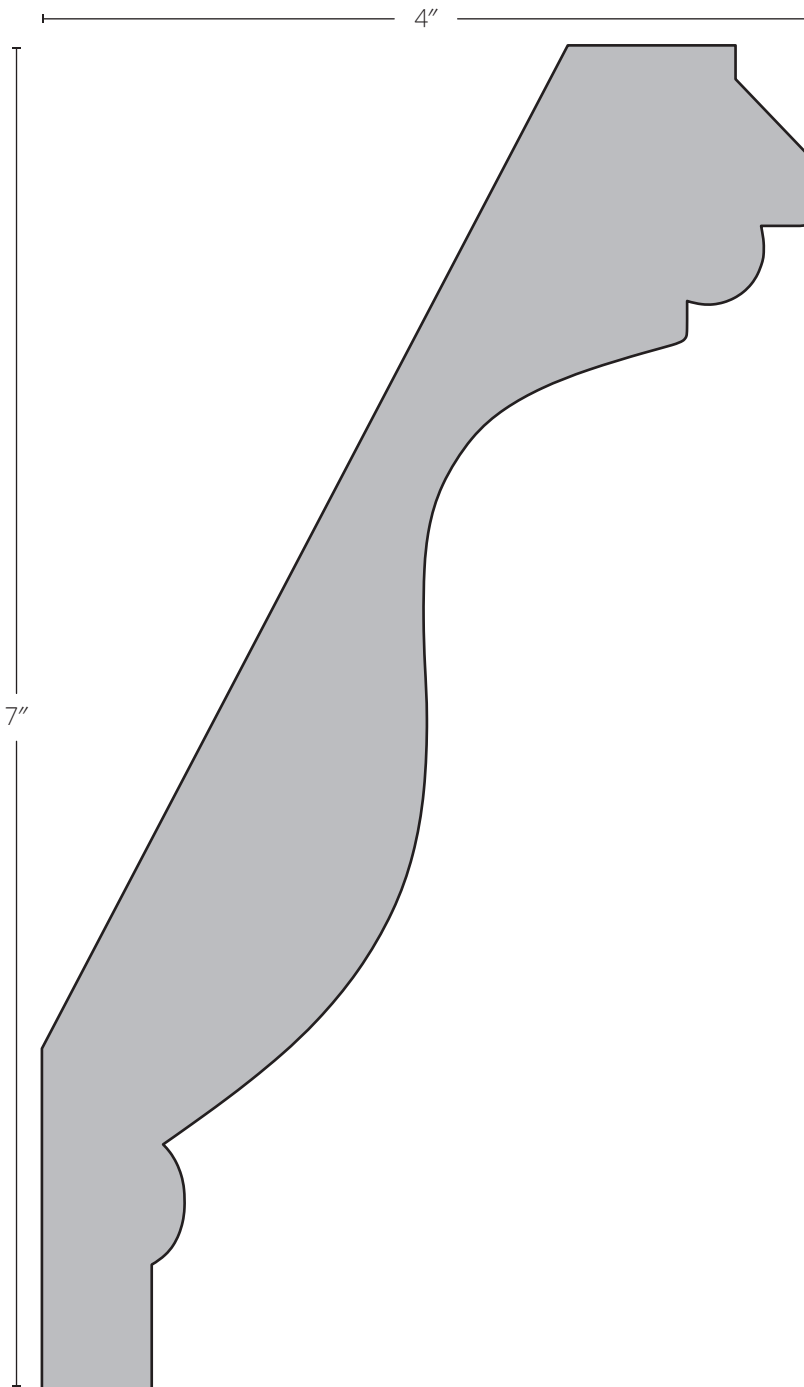

SWD 578 | 1½" x 7⅞" | 30/60

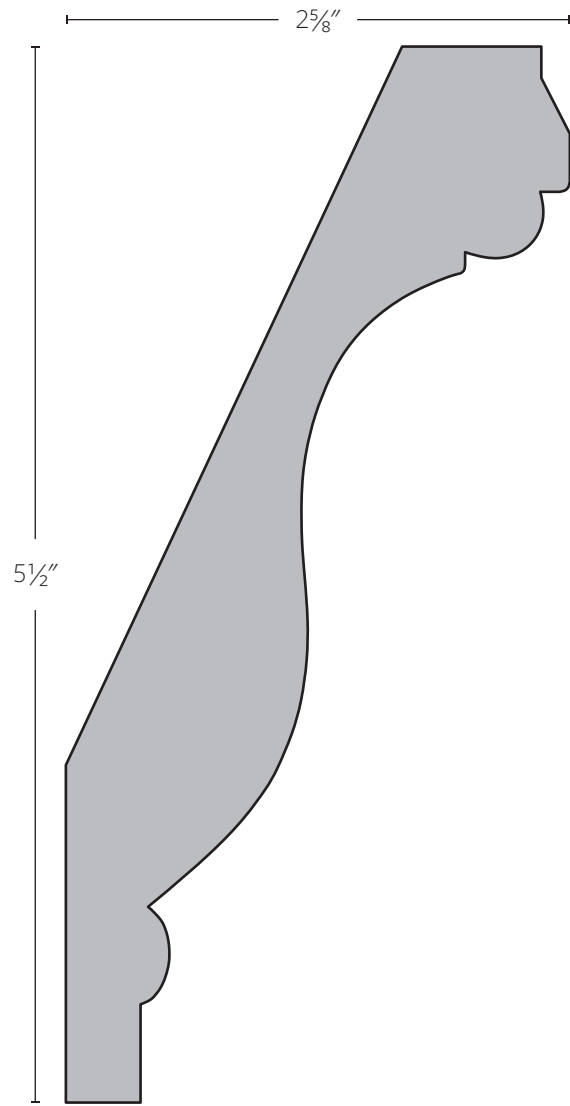

SWD 579 | 1 1/8" x 6" | 30/60

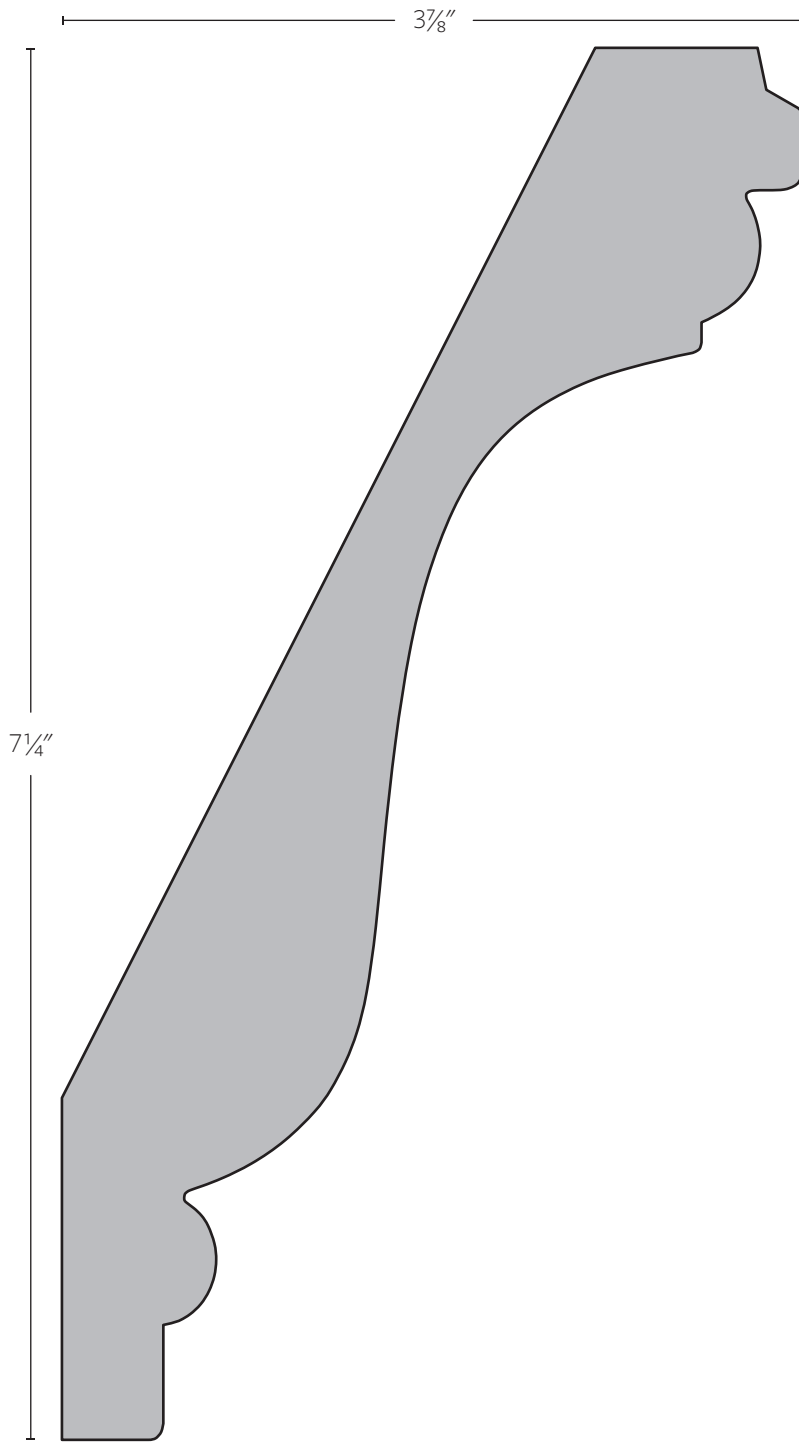

SWD 580 | 1 5/16" x 8 1/8" | 30/60

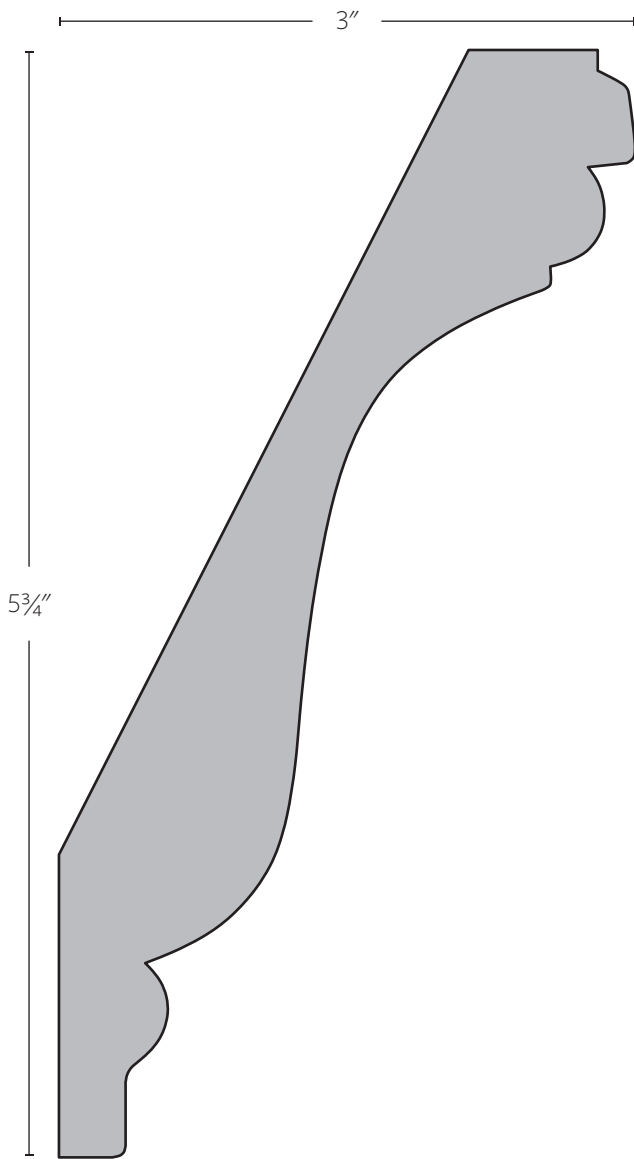

SWD 581 | $1\frac{1}{16}'' \times 6\frac{7}{16}''$ | 30/60

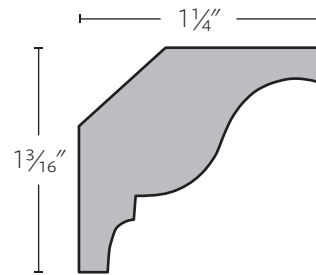

SWD 582 | $\frac{5}{8}'' \times 1\frac{3}{4}''$ | 45/45

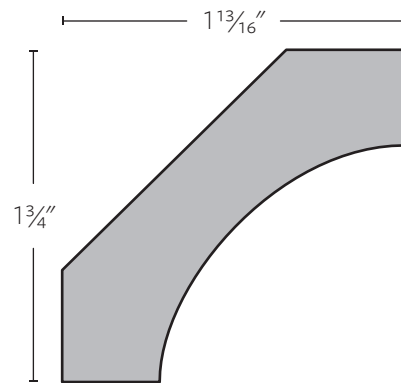

SWD 583 | $\frac{3}{4}'' \times 2\frac{1}{2}''$ | 45/45

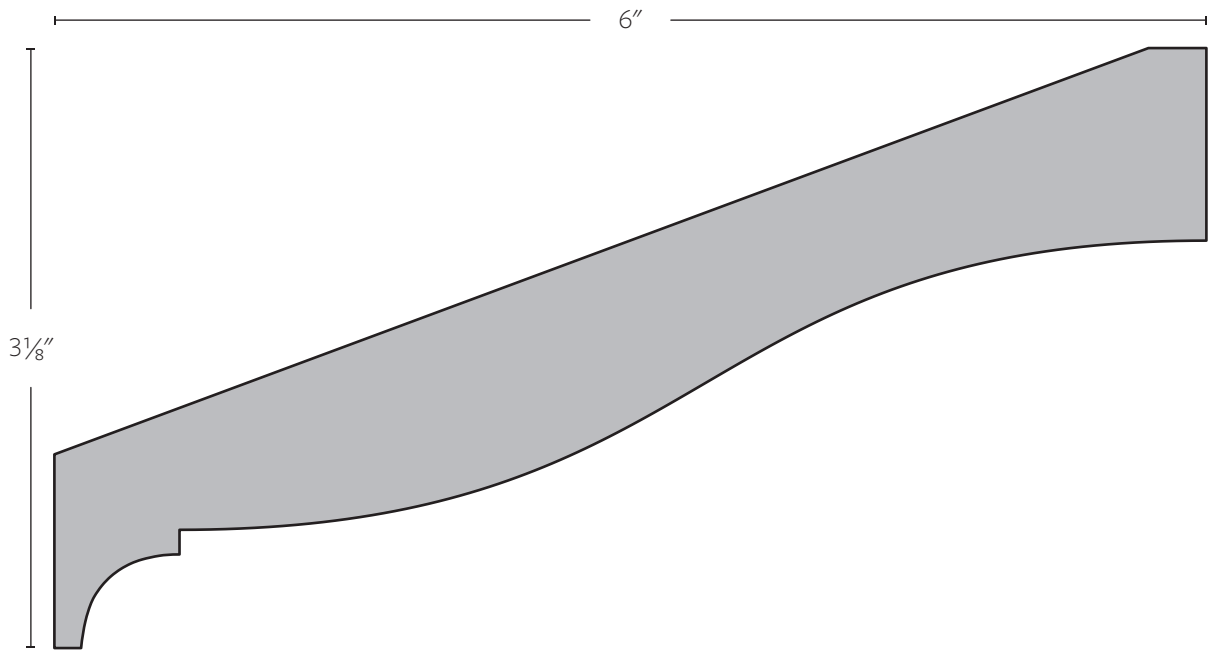

SWD 584 | $1\frac{1}{16}'' \times 6\frac{3}{4}''$ | 19/71

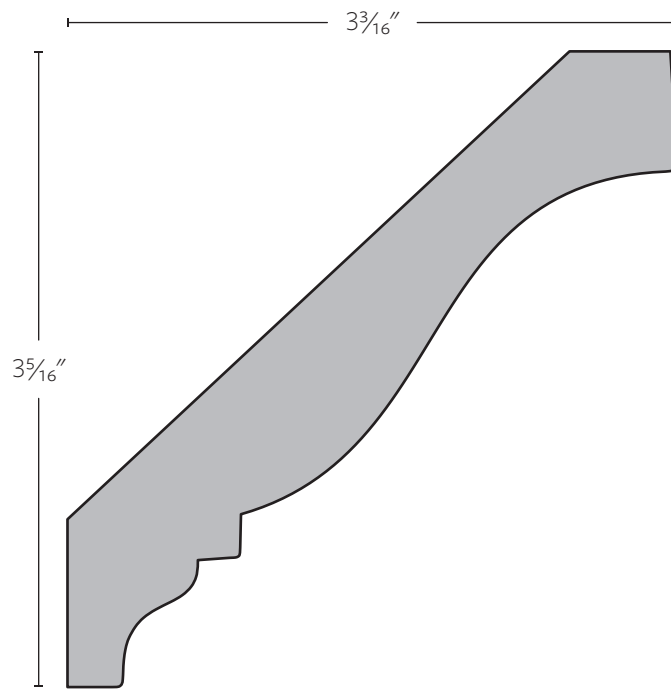

SWD 585 | $\frac{3}{4}'' \times 4\frac{9}{16}''$ | 45/45

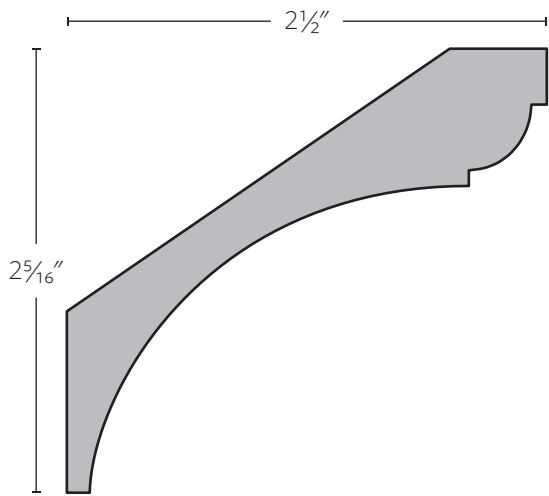

SWD 586 | $\frac{3}{4}'' \times 3\frac{7}{16}''$ | 38/52

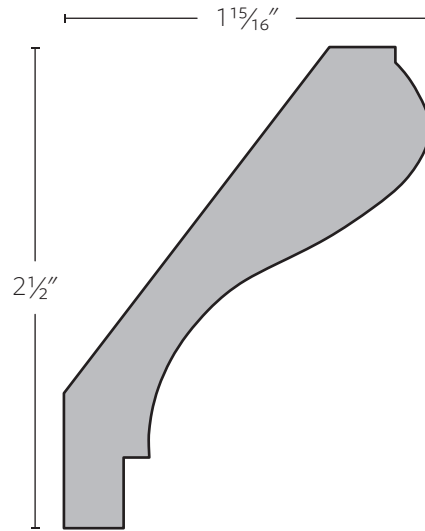

SWD 587 | $\frac{3}{4}'' \times 3\frac{1}{16}''$ | 38/52

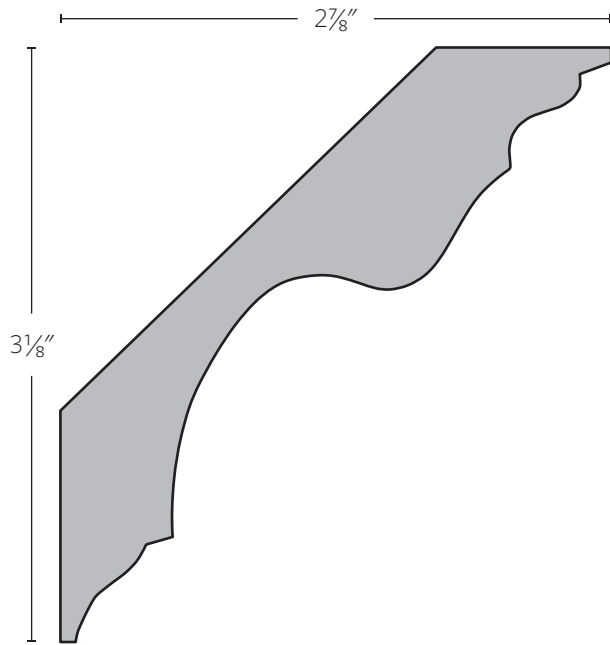

SWD 588 | $\frac{7}{8}'' \times 4\frac{3}{16}''$ | 45/45

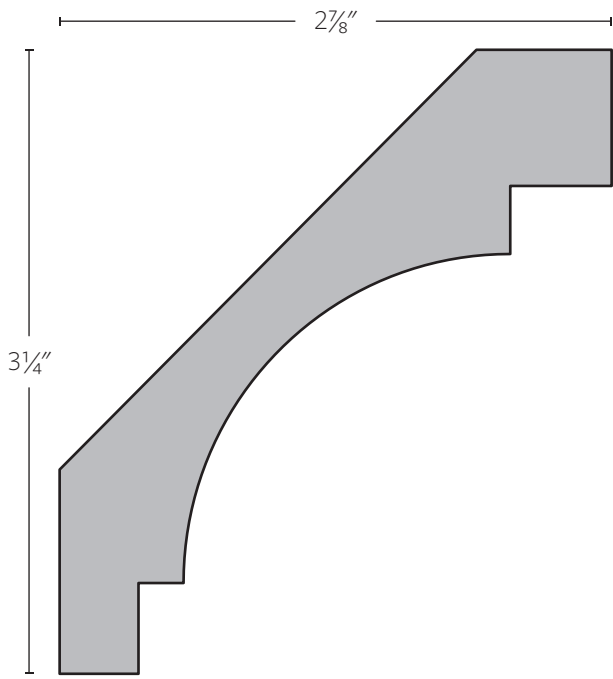

SWD 589 | 1" x 4³/₁₆" | 45/45

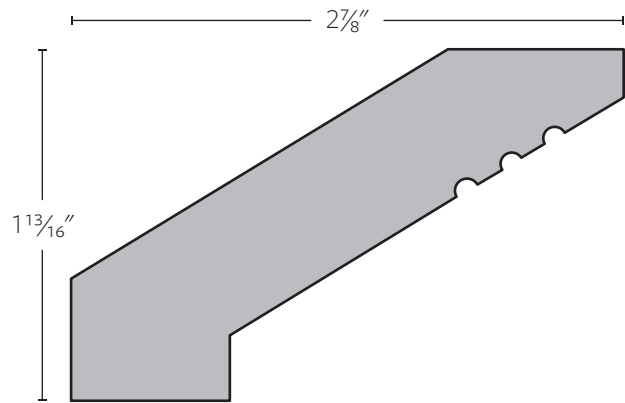

SWD 590 | 1¹/₁₆" x 3⁷/₁₆" | 30/60

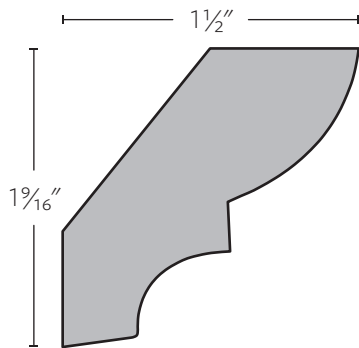

SWD 591 | 3/4" x 2³/₁₆" | 38/52

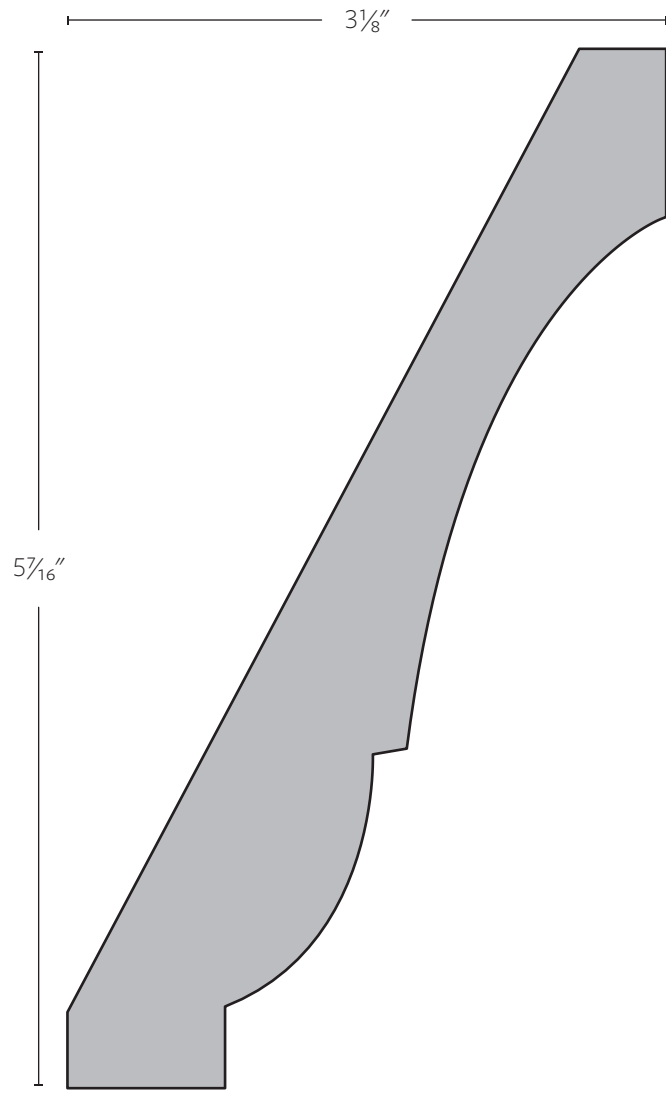

SWD 592 | 1" x 6 $\frac{1}{4}$ " | 30/60

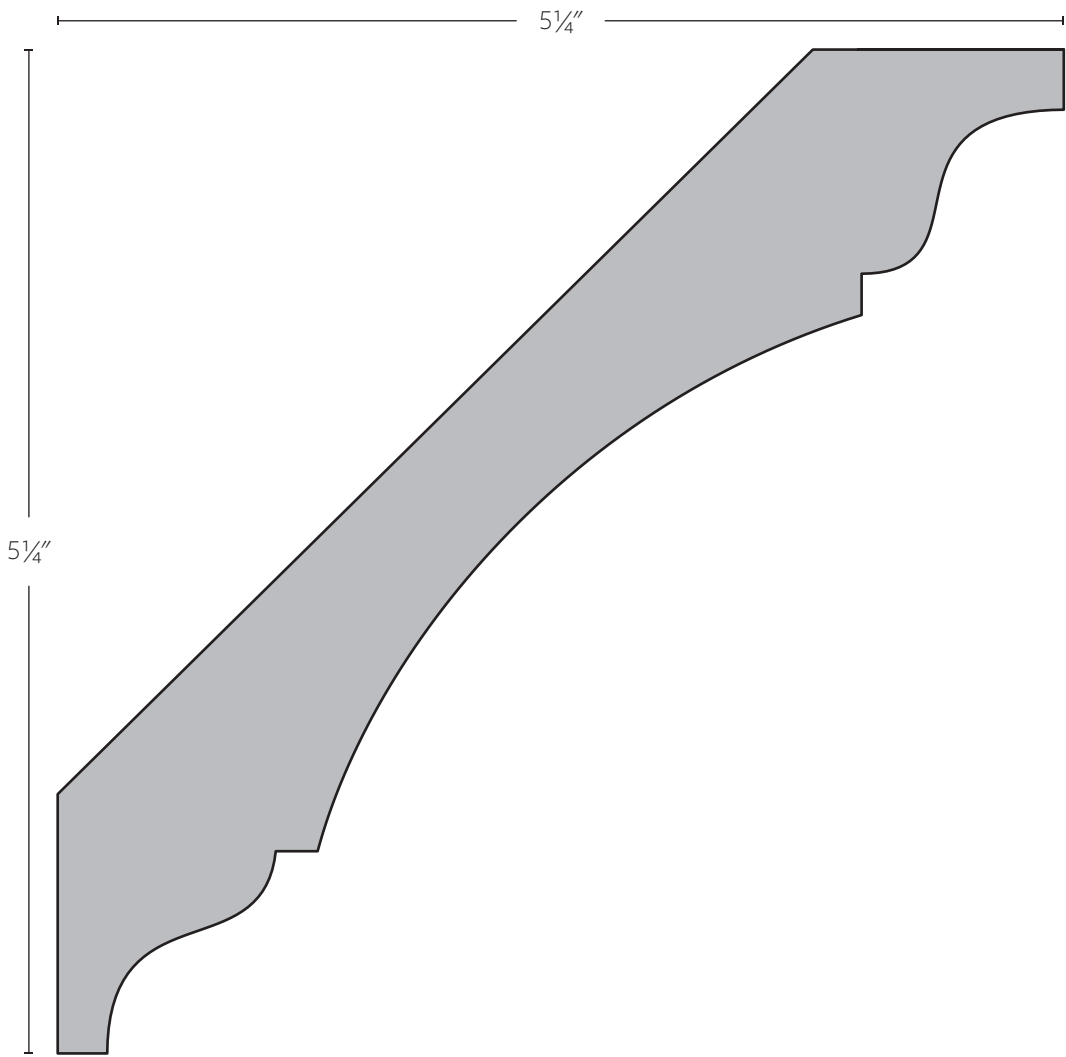

SWD 593 | $1\frac{1}{8}$ " x $7\frac{3}{8}$ " | 45/45

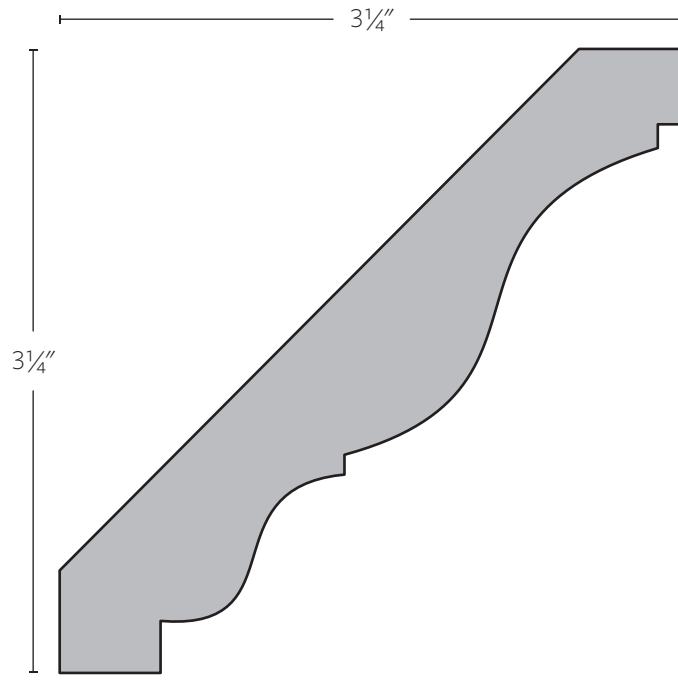

SWD 594 | $\frac{3}{4}'' \times 4\frac{5}{8}''$ | 45/45

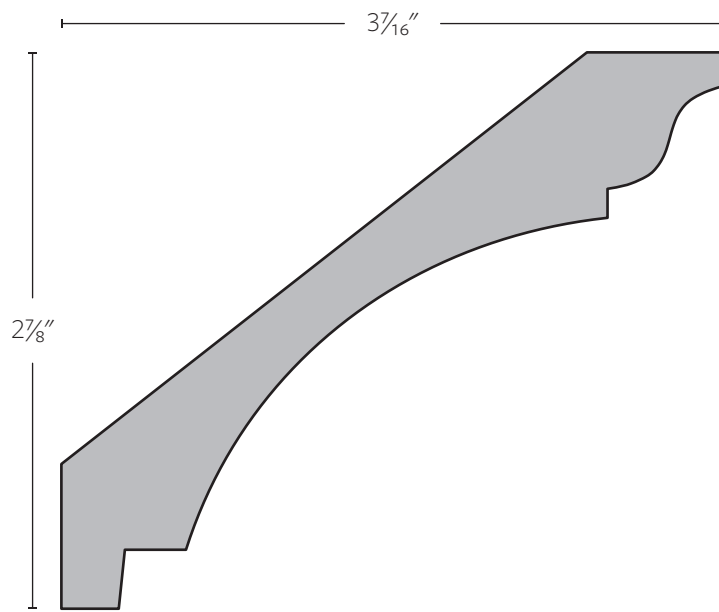

SWD 595 | $\frac{3}{4}'' \times 4\frac{1}{2}''$ | 38/52

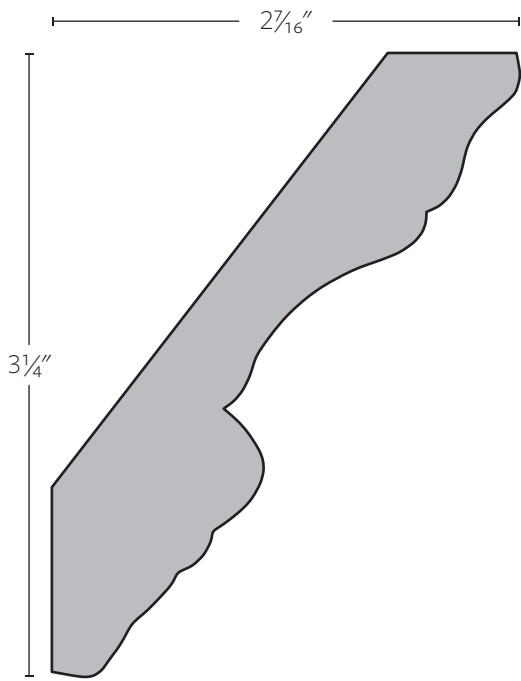

SWD 596 | 7/8" x 4" | 38/52

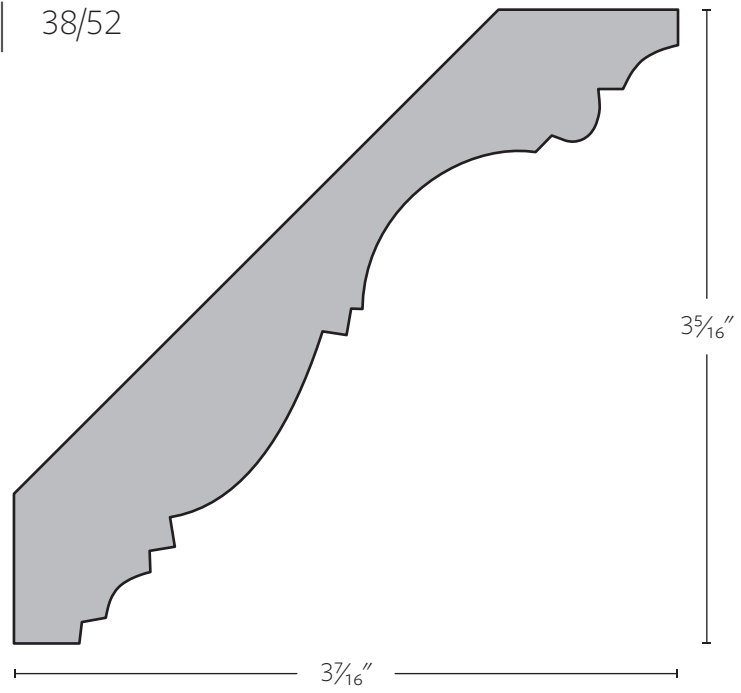

SWD 597 | 1 3/16" x 4 3/4" | 45/45

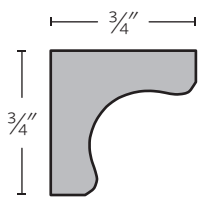

SWD 598 | 3/4" x 3/4"

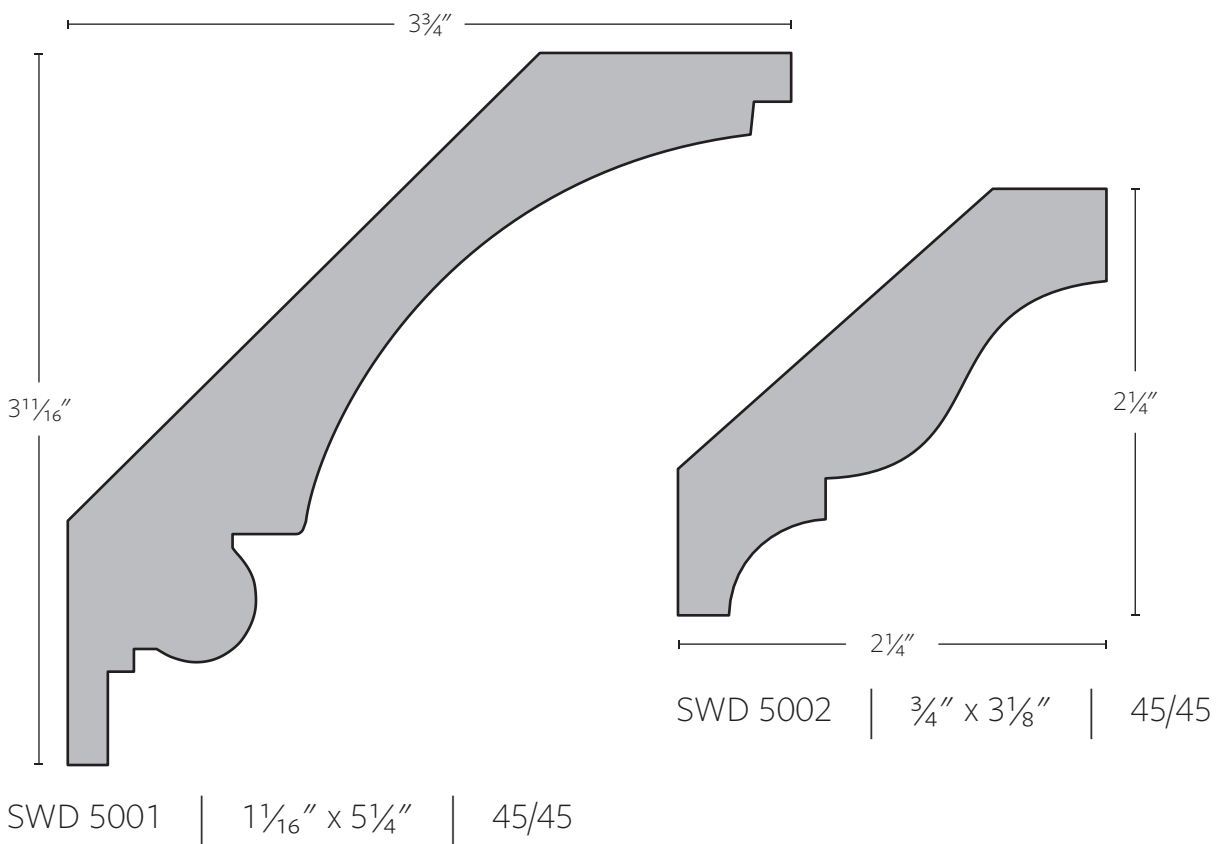
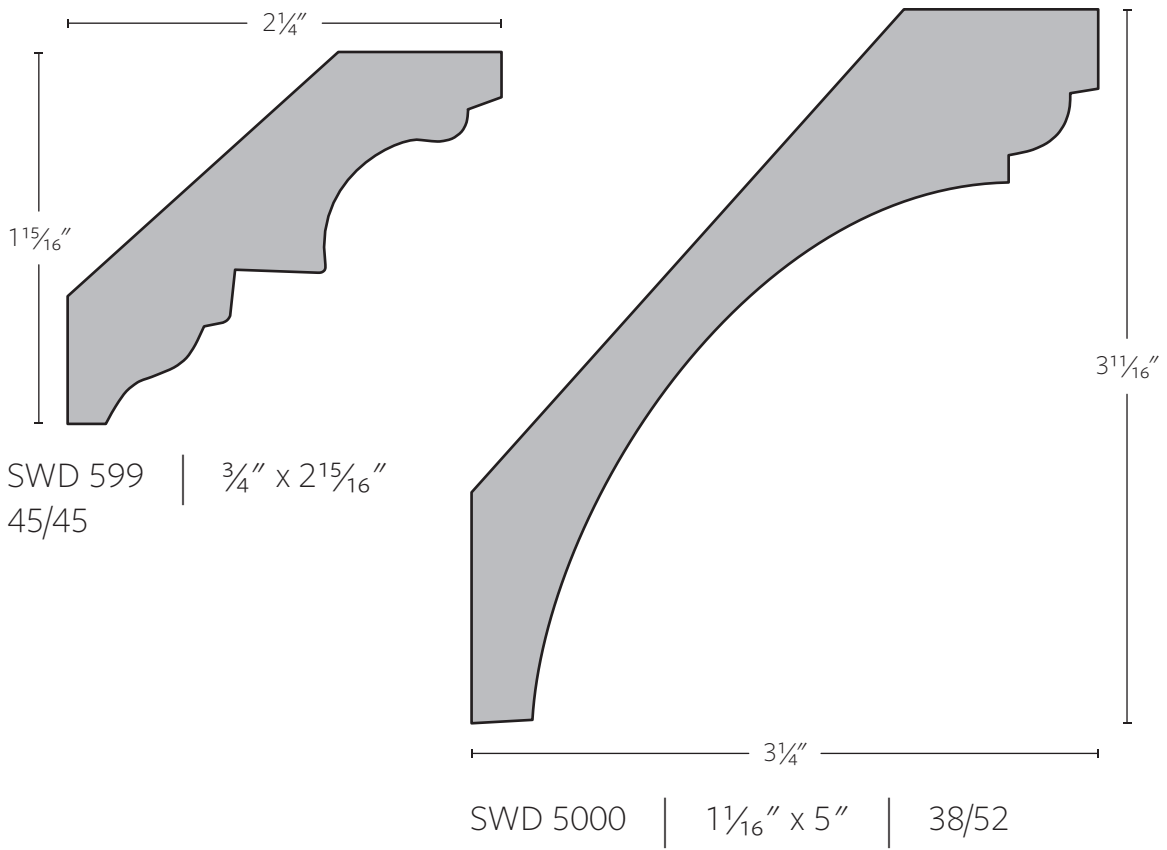

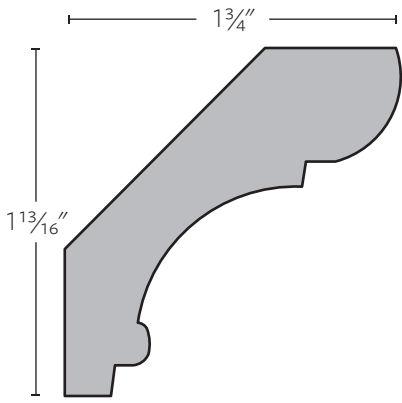

SWD 5003 | 3/4" x 2 1/2" | 45/45

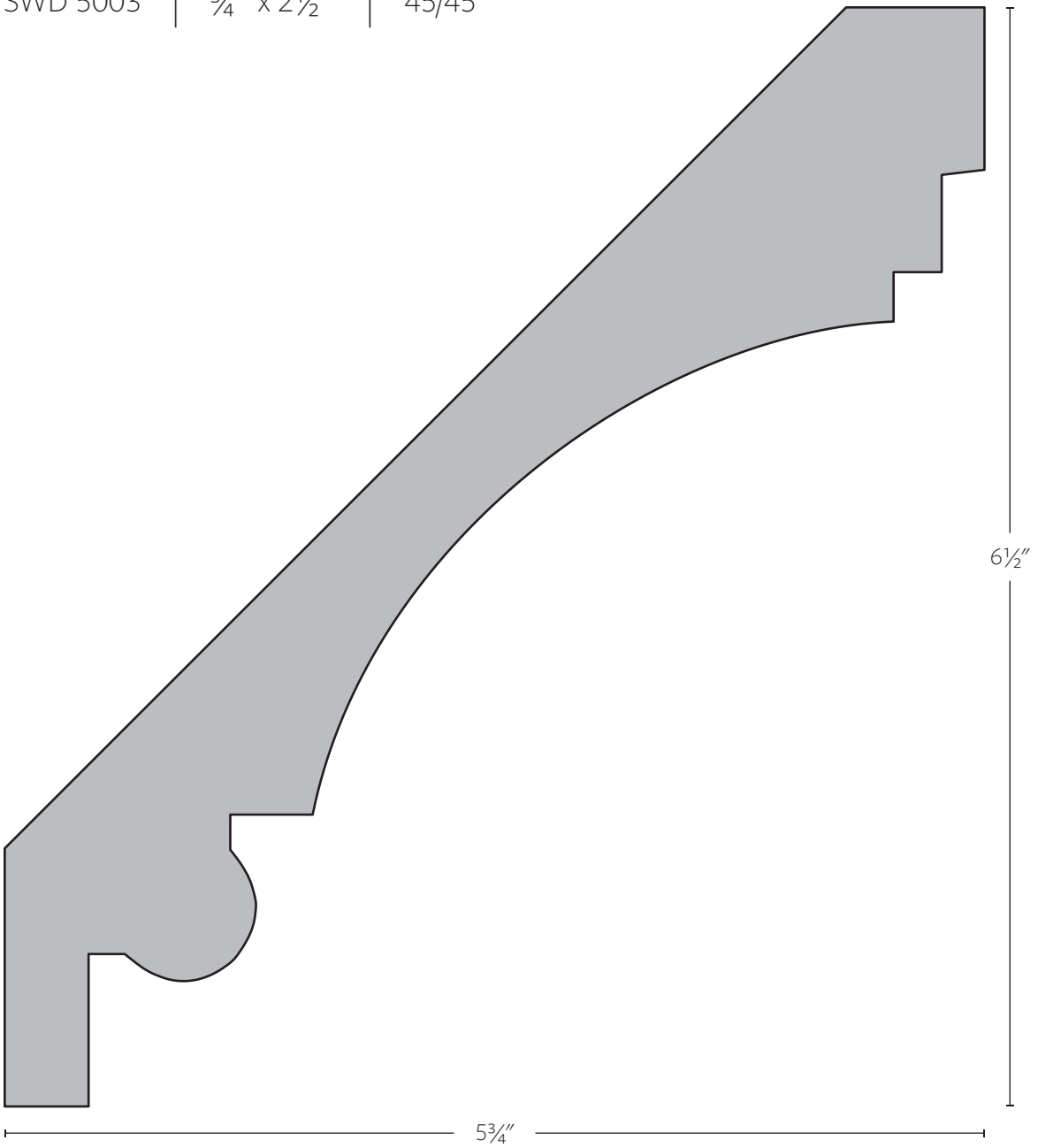

SWD 5004 | 1 1/2" x 8 5/8" | 45/45

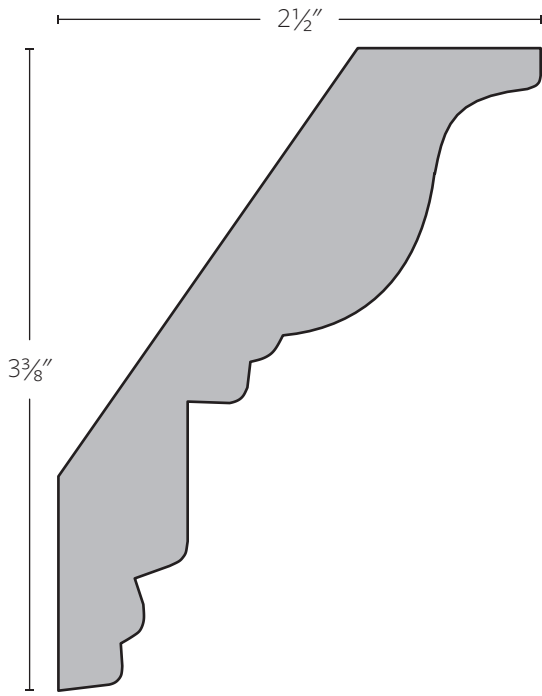

SWD 5005 | $\frac{7}{8}'' \times 4\frac{1}{8}''$ | 38/52

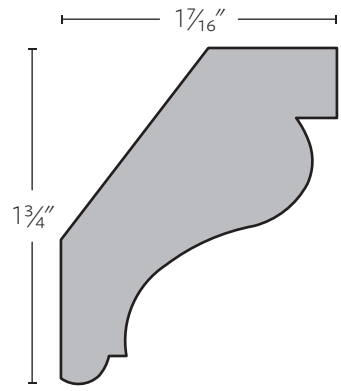

SWD 5006 | $1\frac{3}{16}'' \times 2\frac{3}{16}''$
38/52

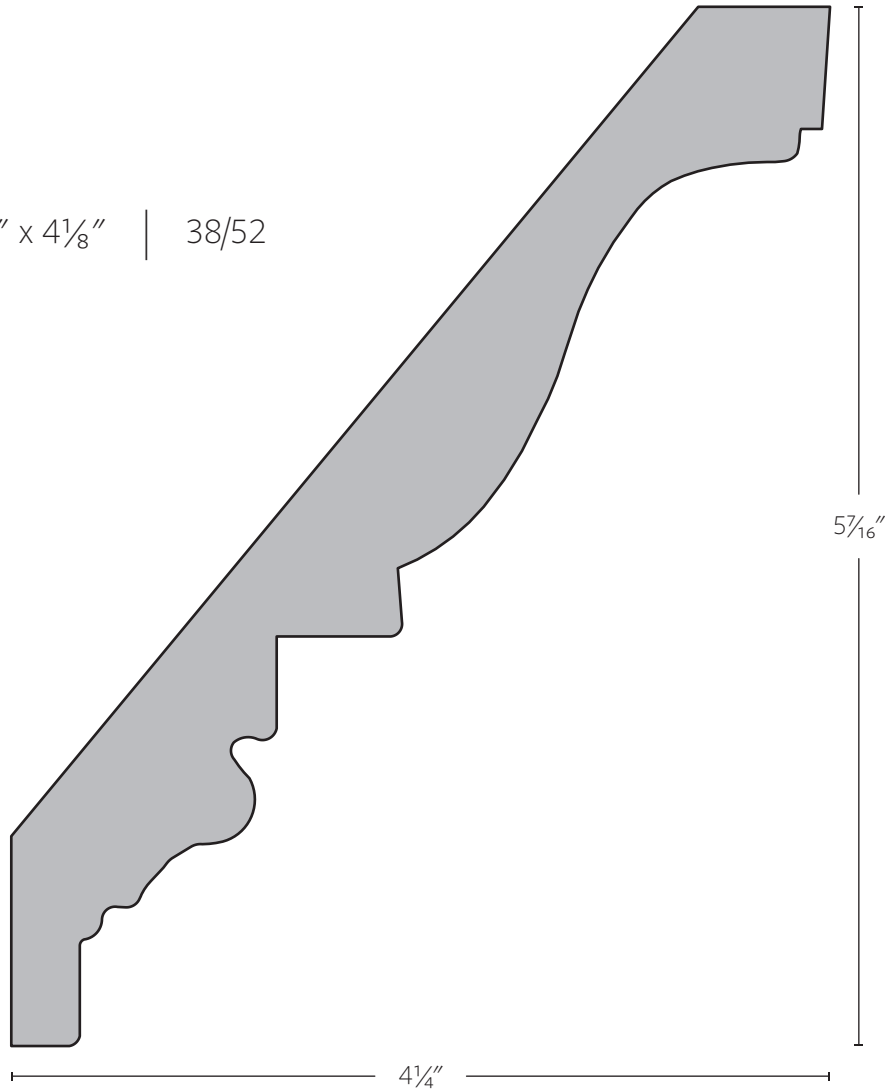

SWD 5007 | $1\frac{5}{16}'' \times 6\frac{13}{16}''$ | 45/45

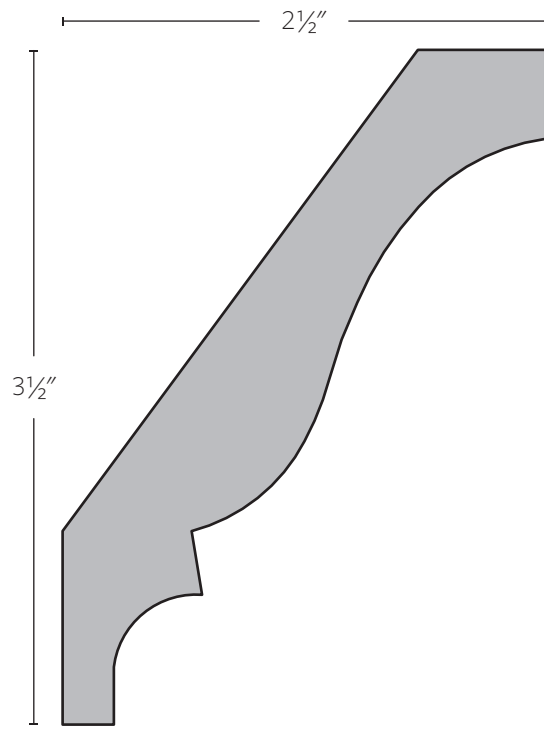

SWD 5008 | 3/4" x 4 1/4" | 38/52

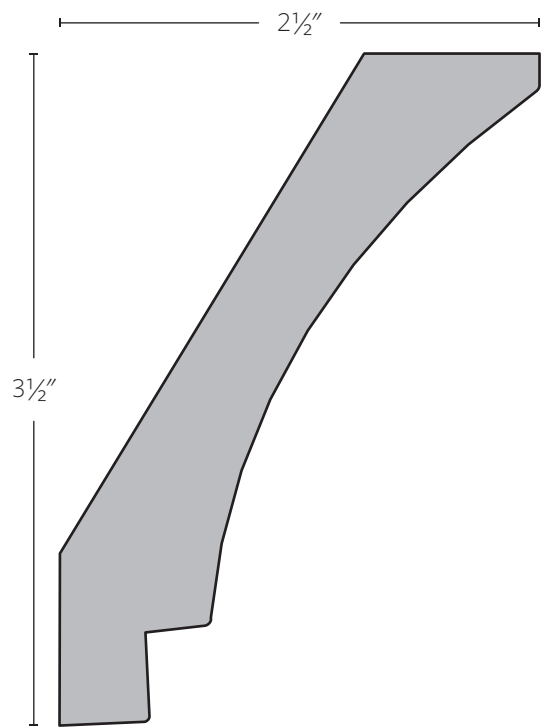

SWD 5009 | 3/4" x 4 1/4" | 30/60

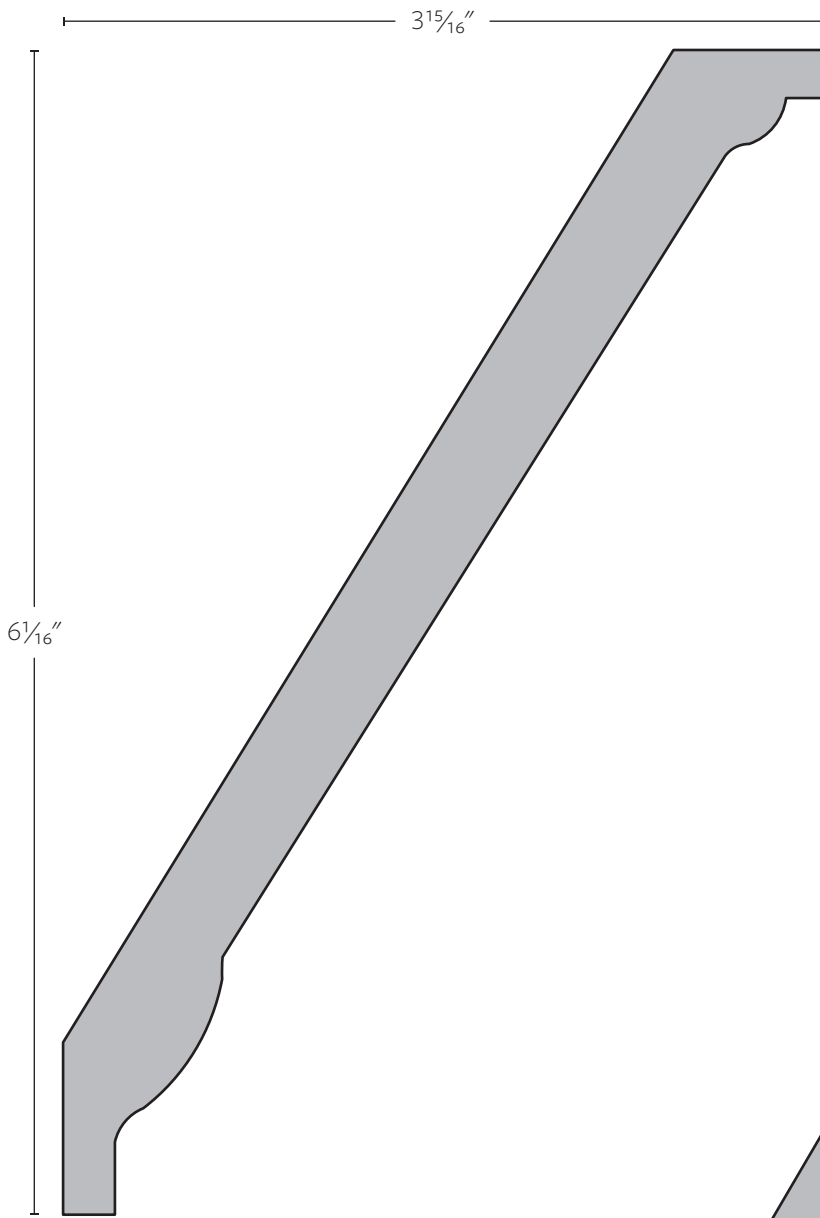

SWD 5010 | $1\frac{3}{16}'' \times 7\frac{1}{4}''$ | 30/60

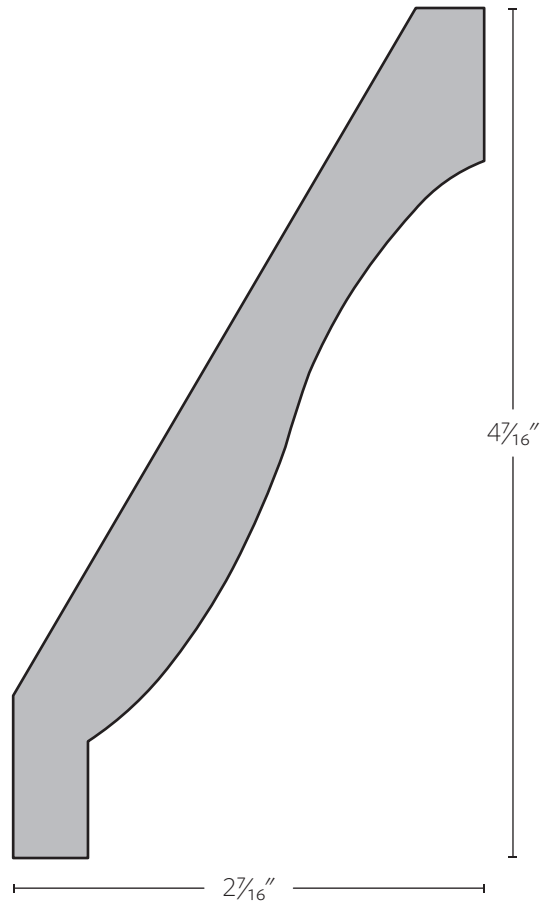

SWD 5011 | $1\frac{1}{16}'' \times 5\frac{1}{16}''$ | 30/60

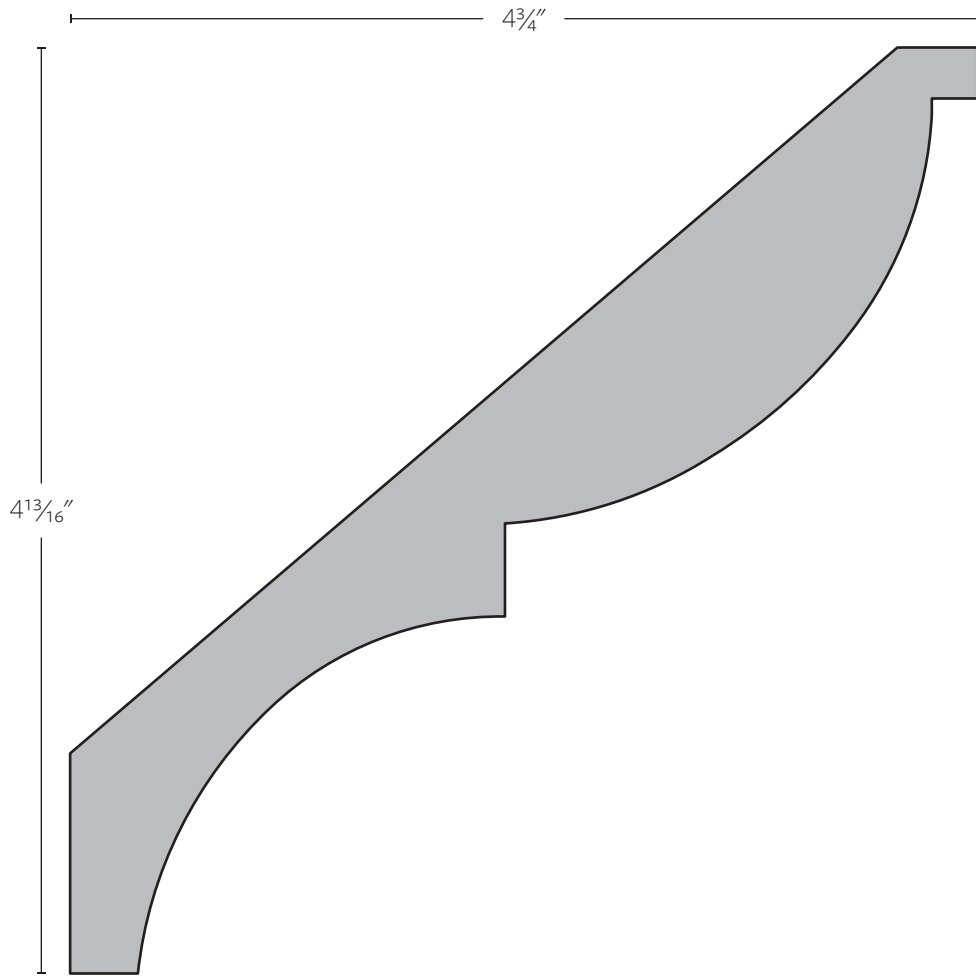

SWD 5012 | $1\frac{1}{16}$ " x $6\frac{3}{4}$ " | 38/52

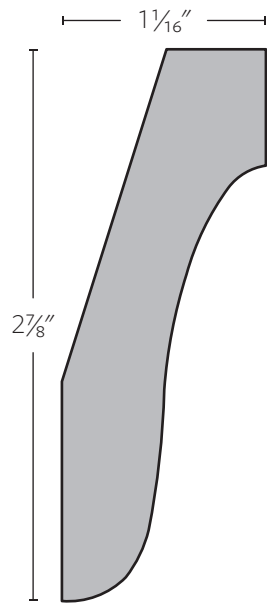

SWD 5013 | $1\frac{1}{16}'' \times 3\frac{1}{16}''$ | 20/70

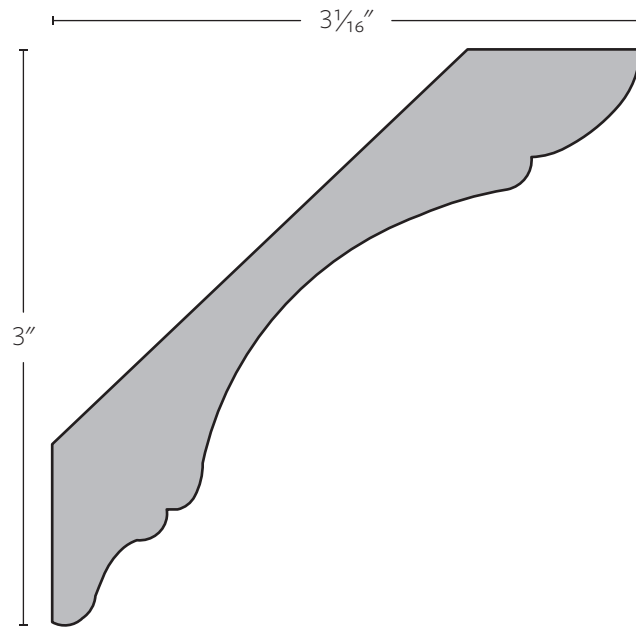

SWD 5014 | $\frac{3}{4}'' \times 4\frac{1}{4}''$ | 45/45



SWD 5015 | 1 5/16" x 7 15/16" | 45/45

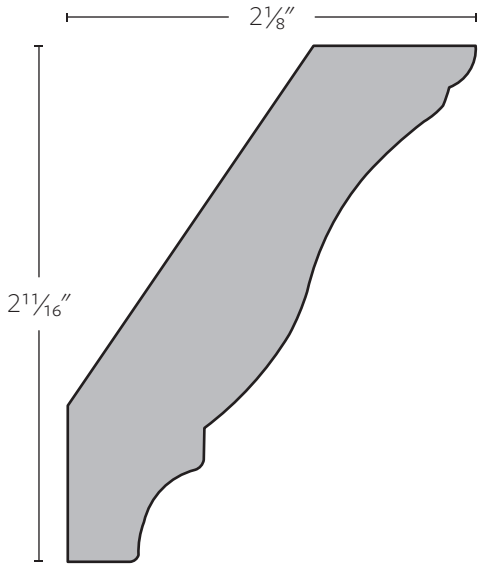

SWD 5016 | $\frac{3}{4}'' \times 3\frac{7}{16}''$ | 38/52

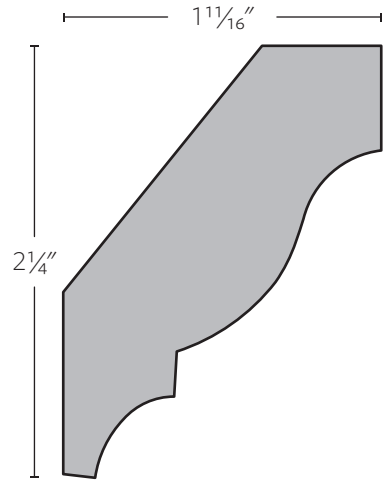

SWD 5018 | $1\frac{3}{16}'' \times 2\frac{3}{4}''$ | 38/52

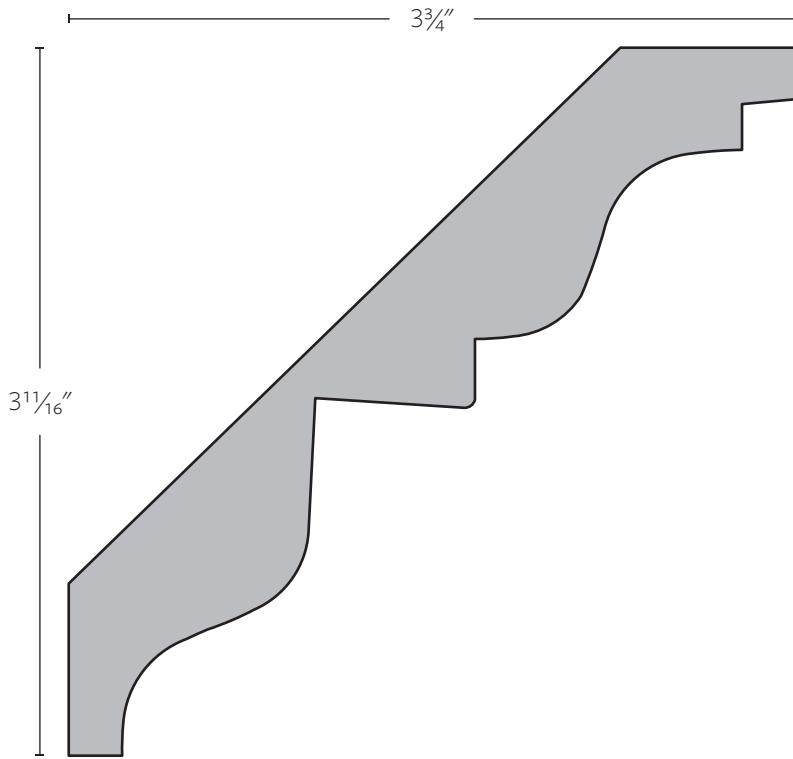

SWD 5017 | $1\frac{3}{16}'' \times 5\frac{1}{4}''$ | 45/45

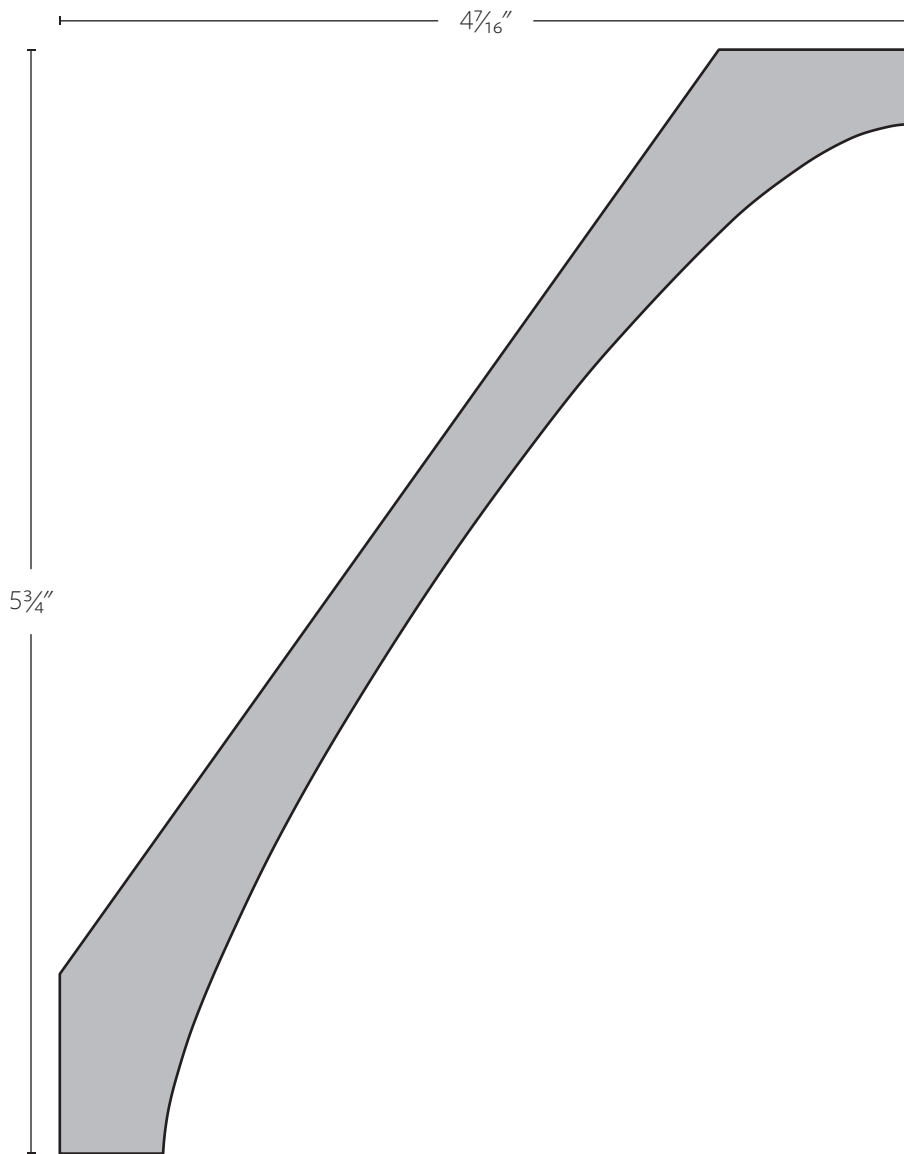

SWD 5019 | 1" x 7 1/4" | 38/52
This profile requires an added setup charge.

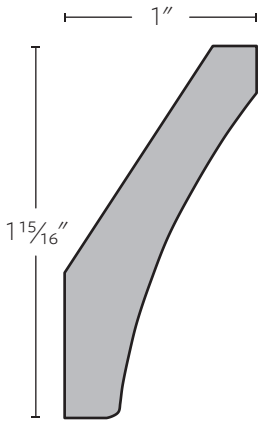

SWD 5020 | $\frac{9}{16}$ " x $2\frac{3}{16}$ " | 38/52

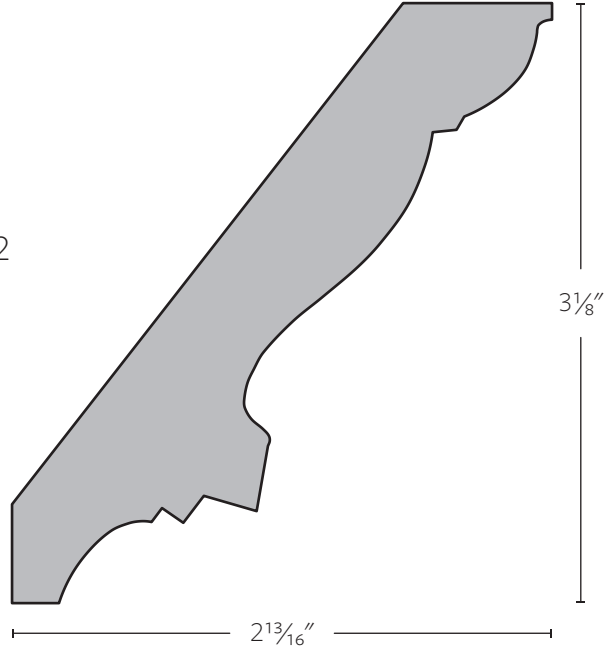

SWD 5021 | 1" x $4\frac{1}{8}$ " | 38/52

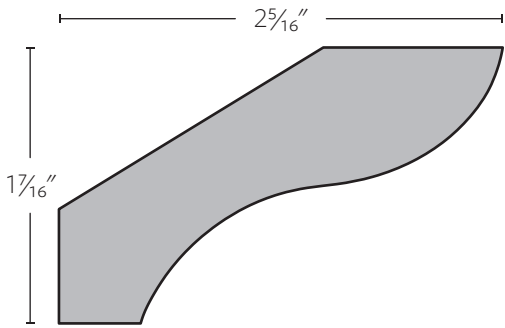

SWD 5022 | $\frac{3}{4}$ " x $2\frac{1}{16}$ " | 30/60

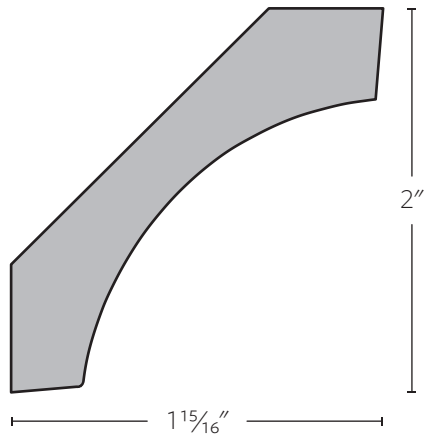

SWD 5023 | $\frac{3}{4}$ " x $2\frac{3}{4}$ " | 45/45

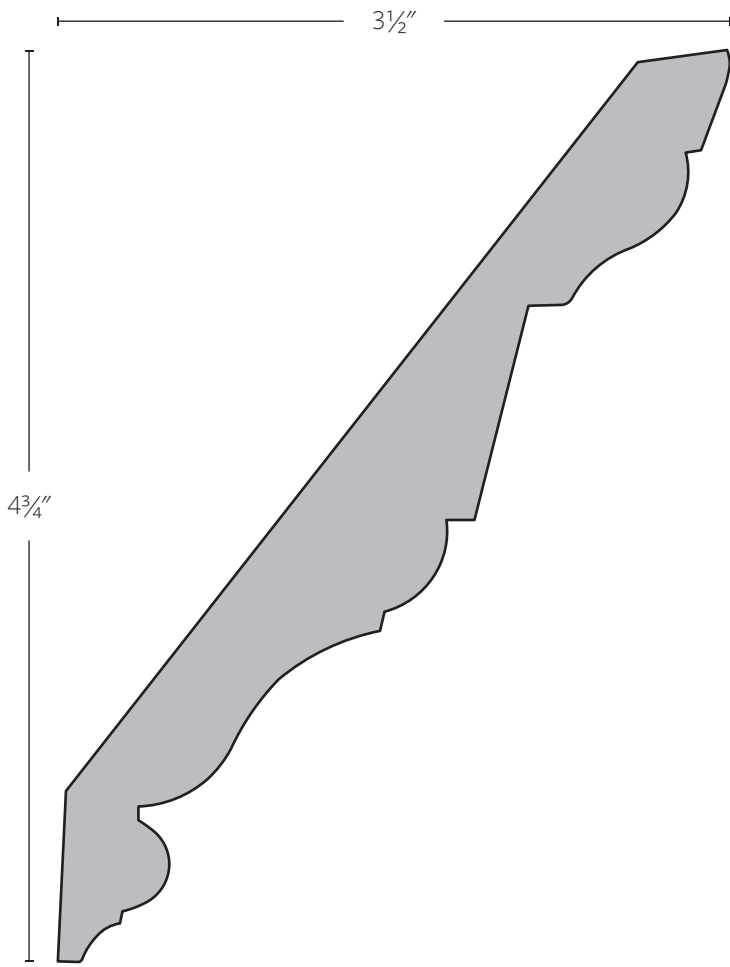

SWD 5024 | $1\frac{3}{16}'' \times 5\frac{13}{16}''$ | 38/52

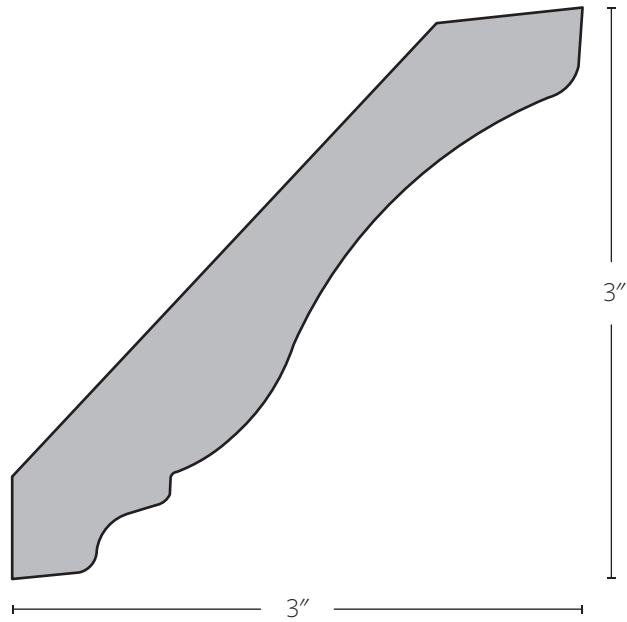

SWD 5025 | $\frac{3}{4}'' \times 4\frac{1}{8}''$ | 45/45

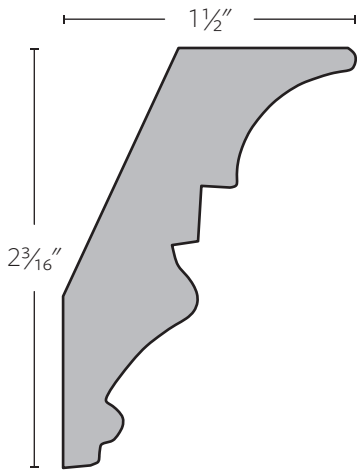

SWD 5026 | $\frac{7}{8}'' \times 2\frac{1}{16}''$ | 30/60

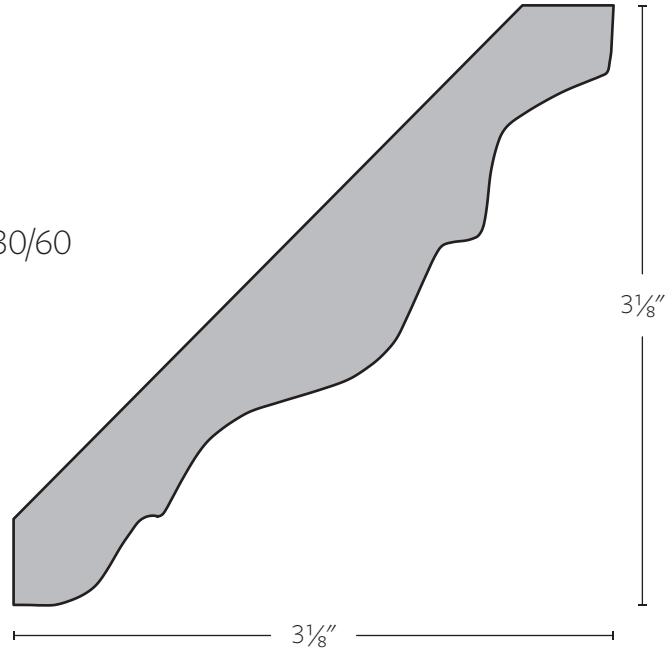

SWD 5027 | $\frac{3}{4}'' \times 4\frac{3}{8}''$ | 45/45

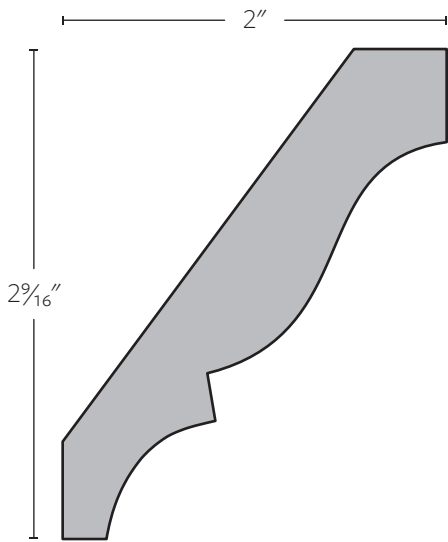

SWD 5028 | $\frac{3}{4}'' \times 3\frac{1}{4}''$ | 38/52

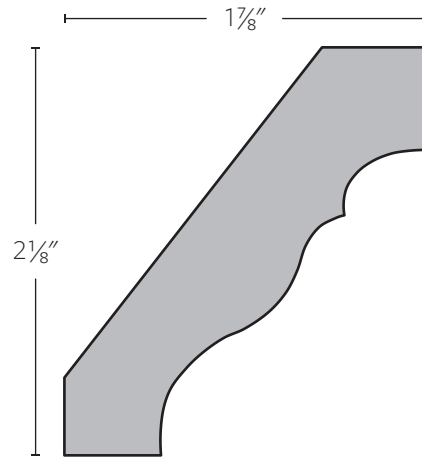

SWD 5029 | $\frac{3}{4}'' \times 2\frac{13}{16}''$ | 45/45

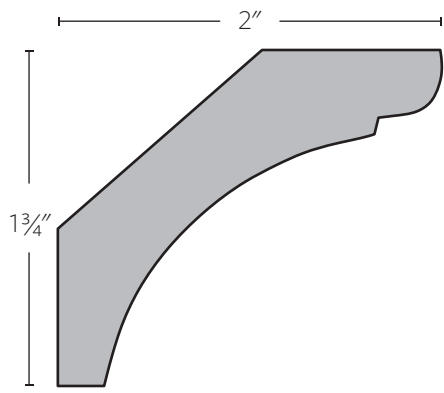

SWD 5030 | $\frac{3}{4}'' \times 2\frac{1}{2}''$ | 45/45

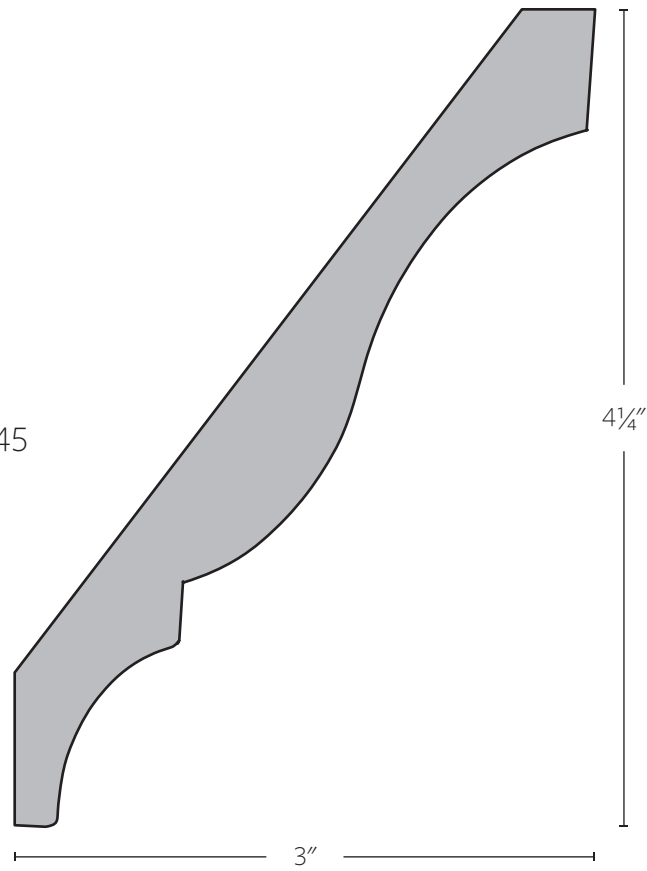

SWD 5031 | $1\frac{1}{16}'' \times 5\frac{1}{4}''$ | 38/52

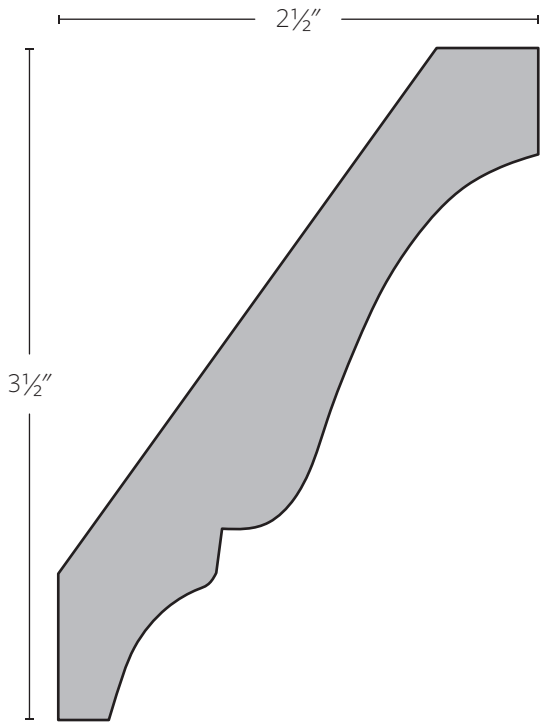

SWD 5032 | $1\frac{3}{16}'' \times 4\frac{1}{4}''$ | 38/52

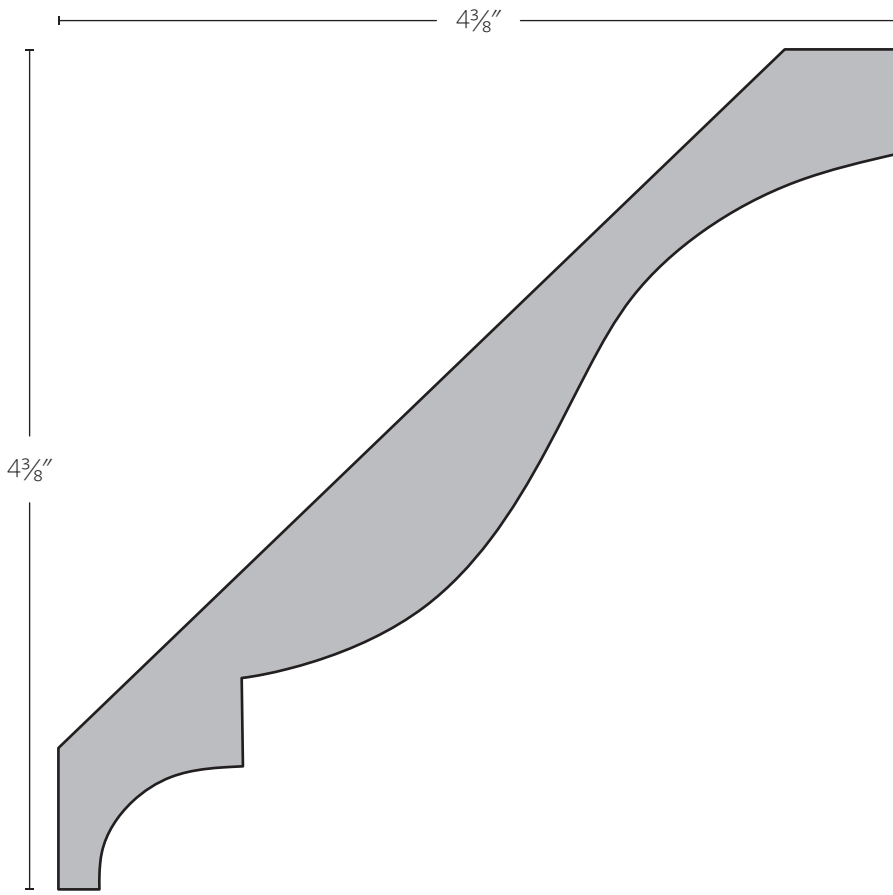

SWD 5033 | $1\frac{3}{16}'' \times 6\frac{3}{16}''$ | 45/45

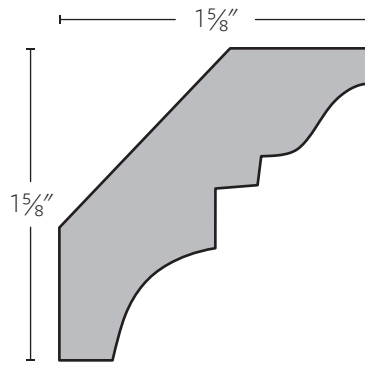

SWD 5034 | $\frac{3}{4}'' \times 2\frac{9}{16}''$ | 45/45

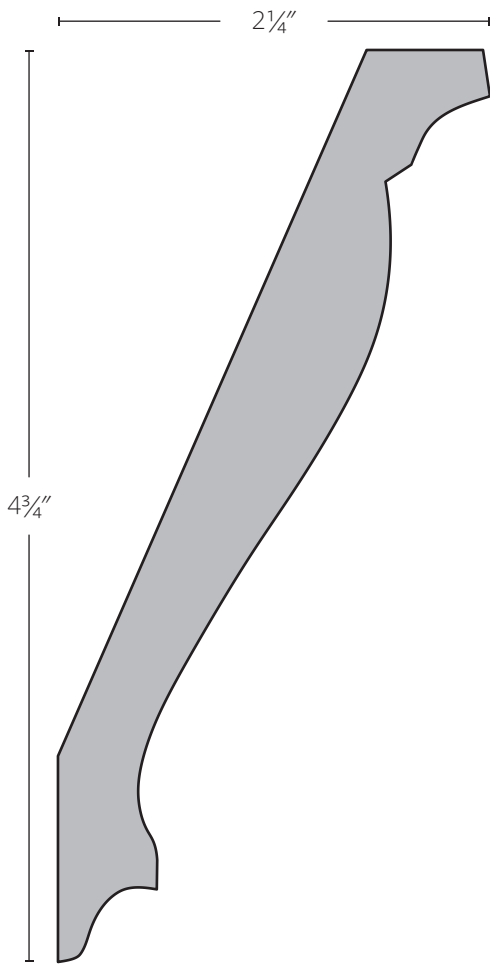

SWD 5035 | $\frac{3}{4}'' \times 5\frac{1}{8}''$ | 19/71

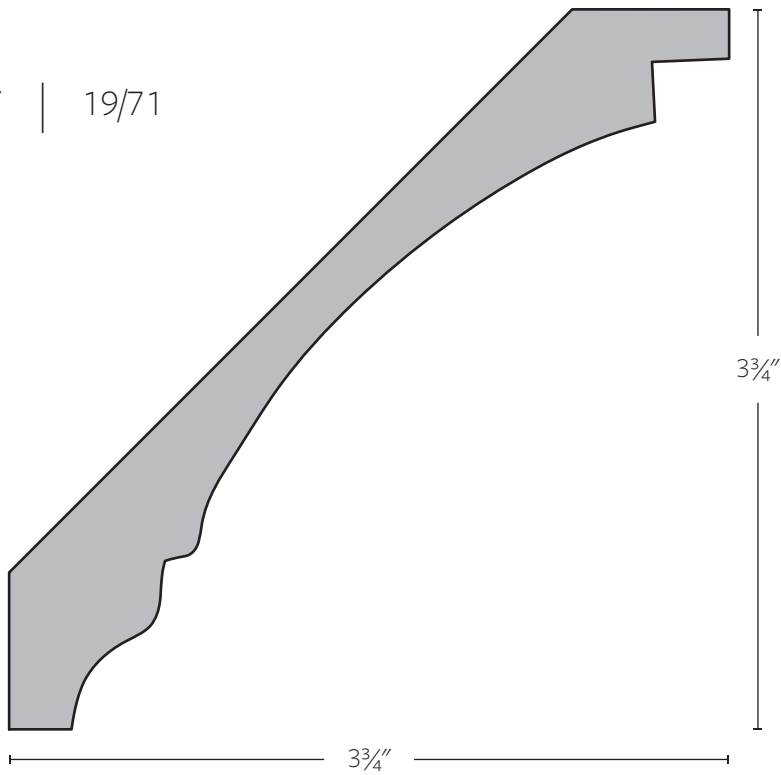

SWD 5036 | $\frac{13}{16}'' \times 5\frac{3}{8}''$ | 45/45

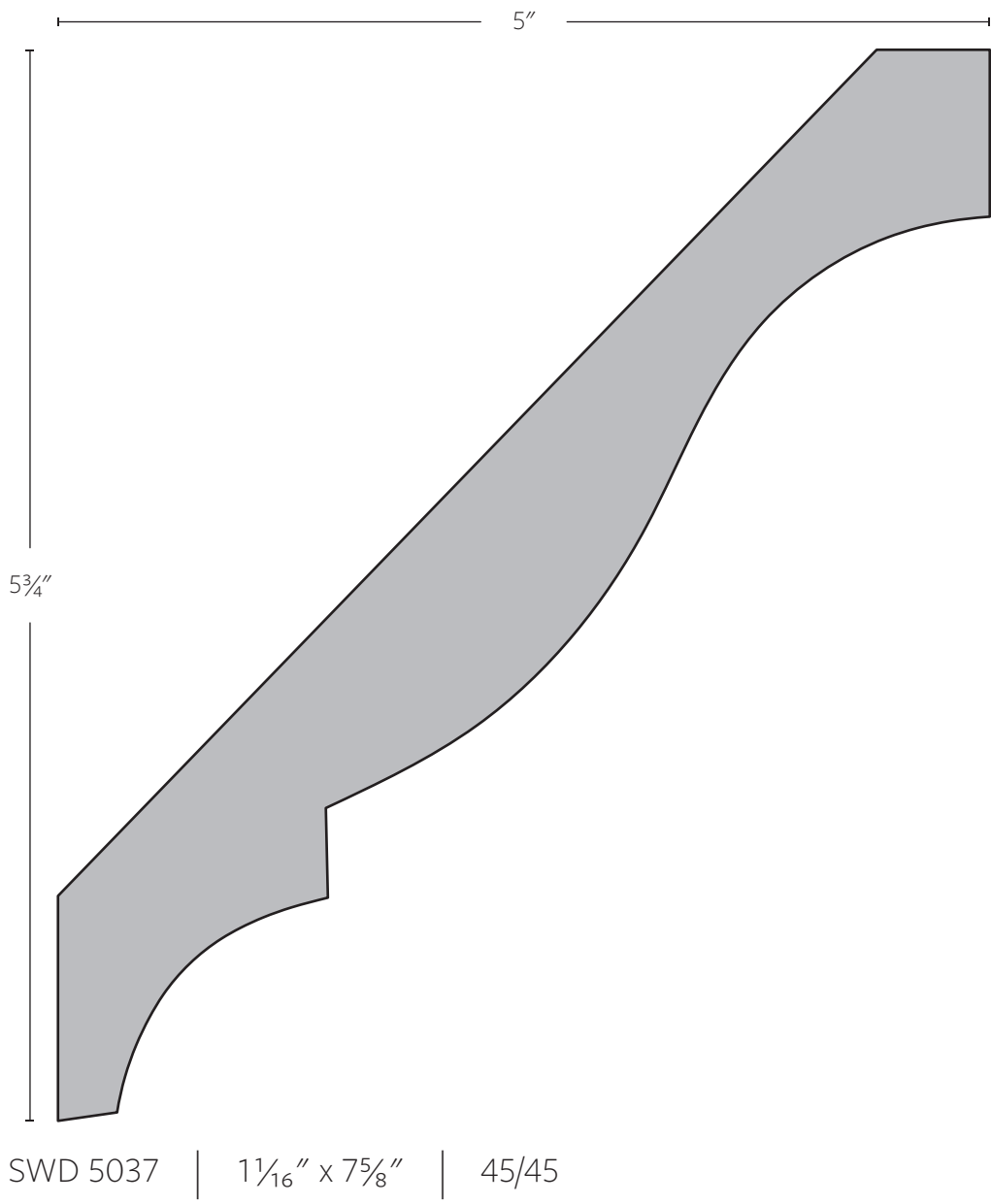

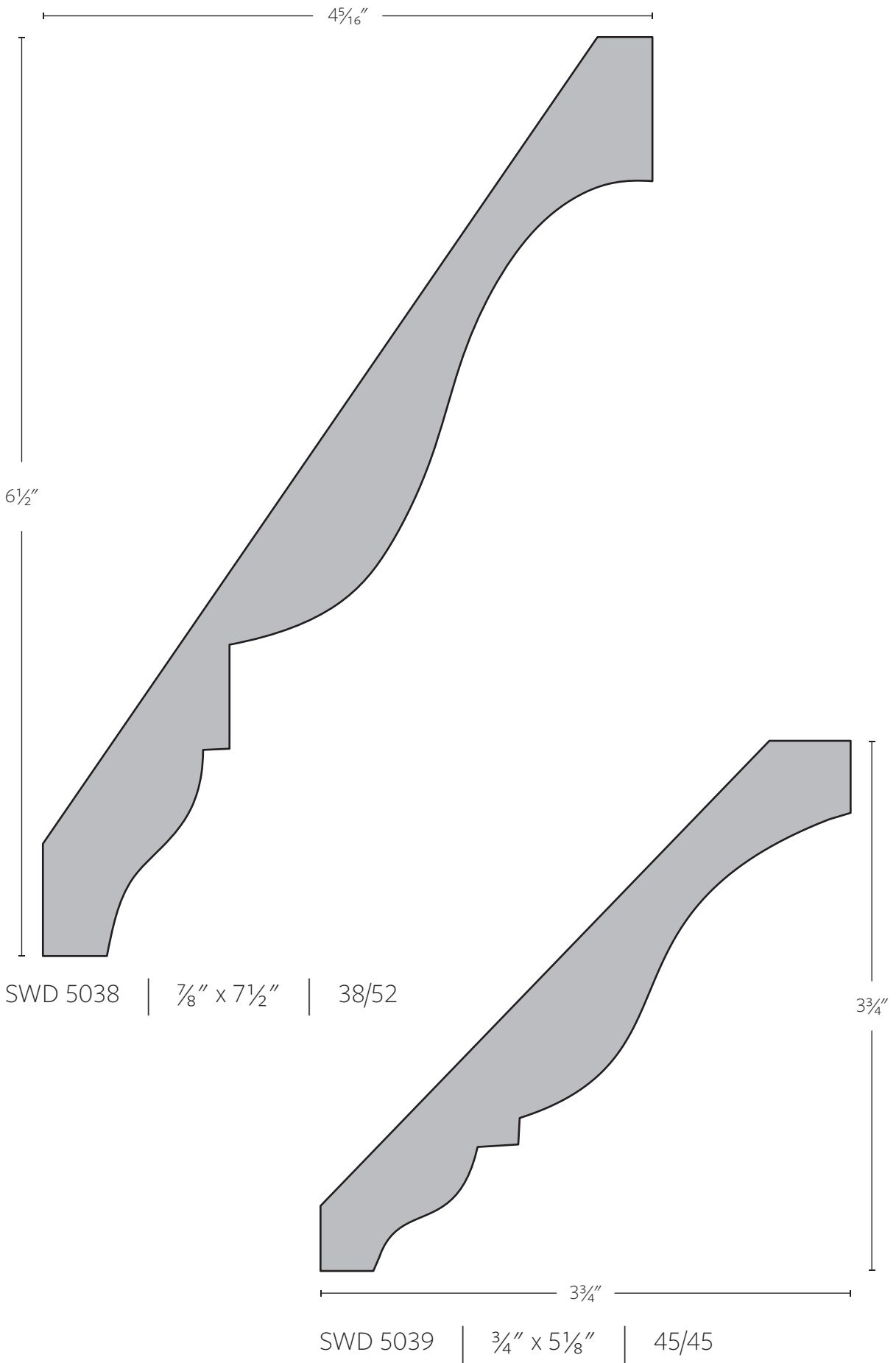

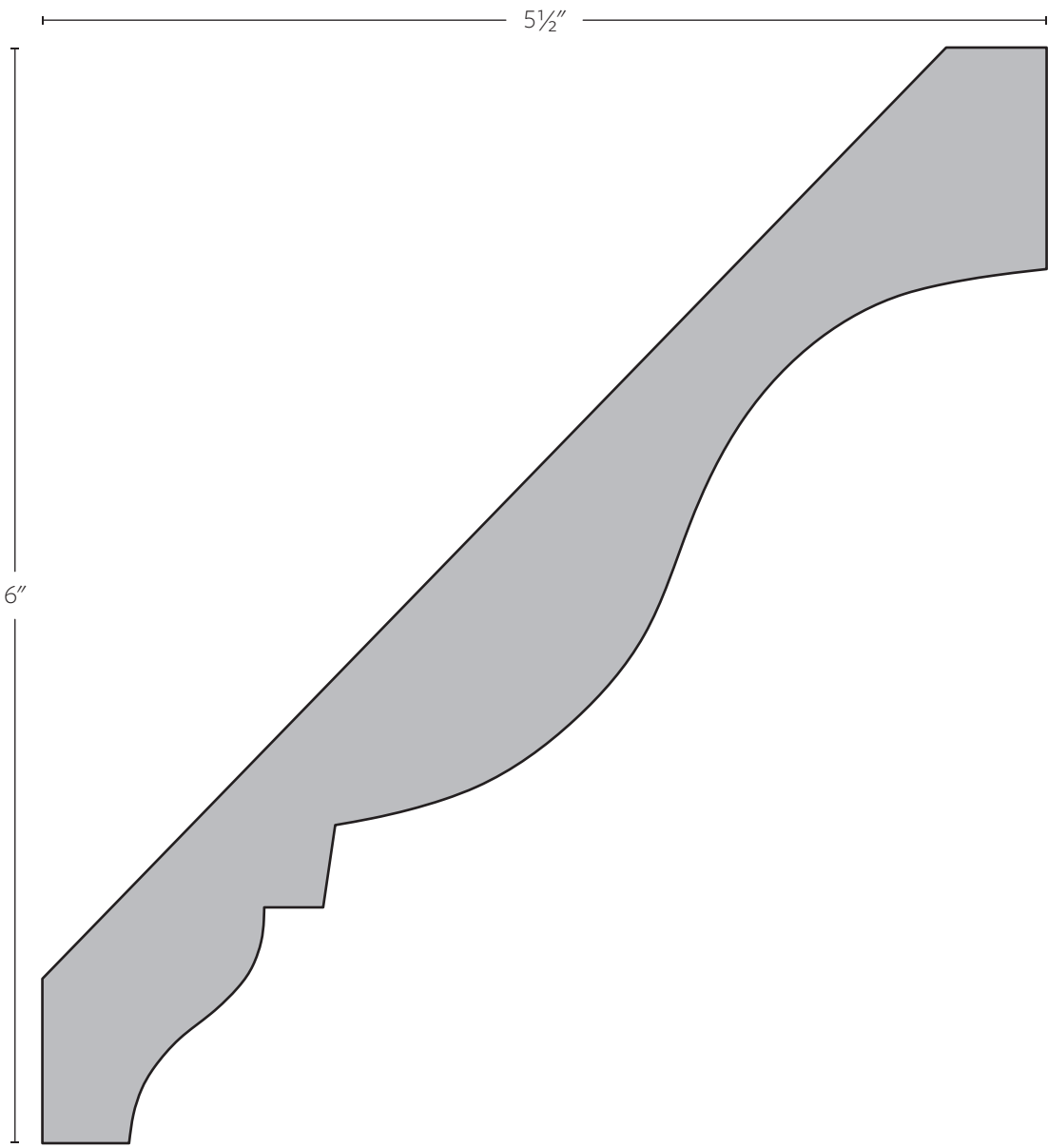

SWD 5040 | $1\frac{3}{16}'' \times 8\frac{1}{8}''$ | 45/45

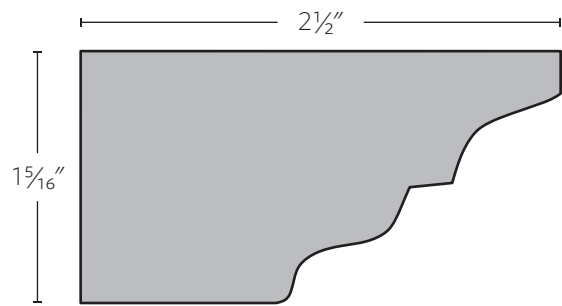

SWD 5041 | $1\frac{5}{16}'' \times 2\frac{1}{2}''$

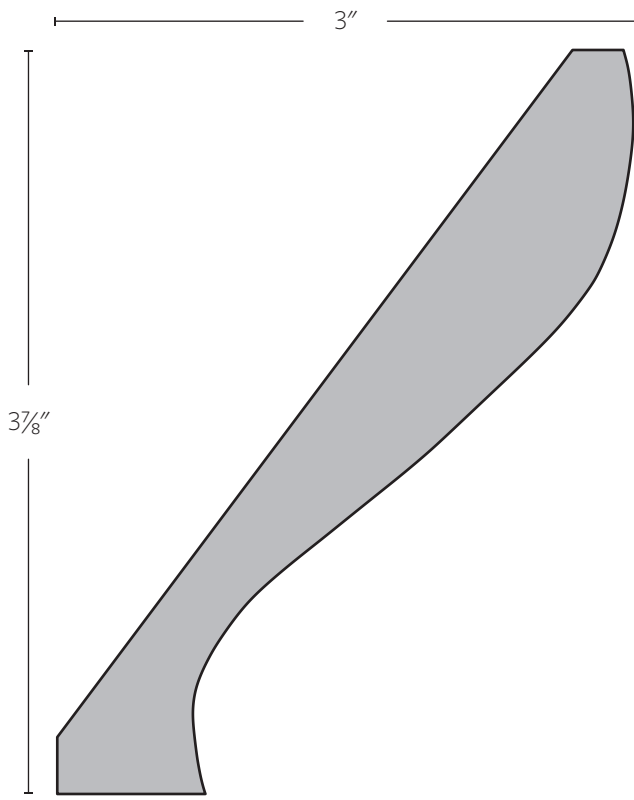

SWD 5042 | $1\frac{3}{16}$ " x $4\frac{13}{16}$ " | 30/60

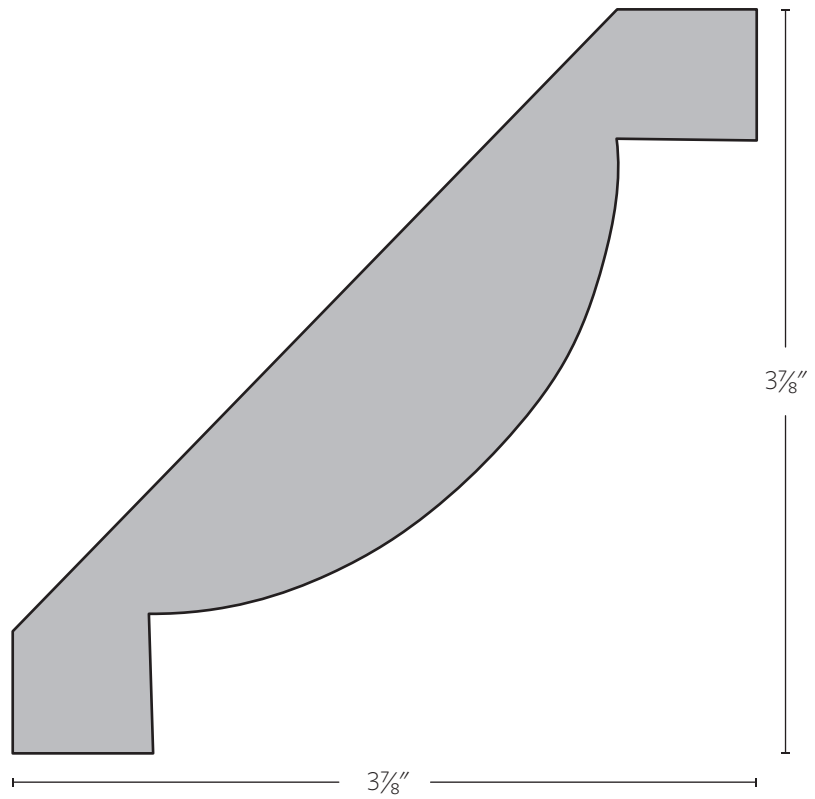

SWD 5043 | $1\frac{3}{16}$ " x $5\frac{5}{8}$ " | 45/45

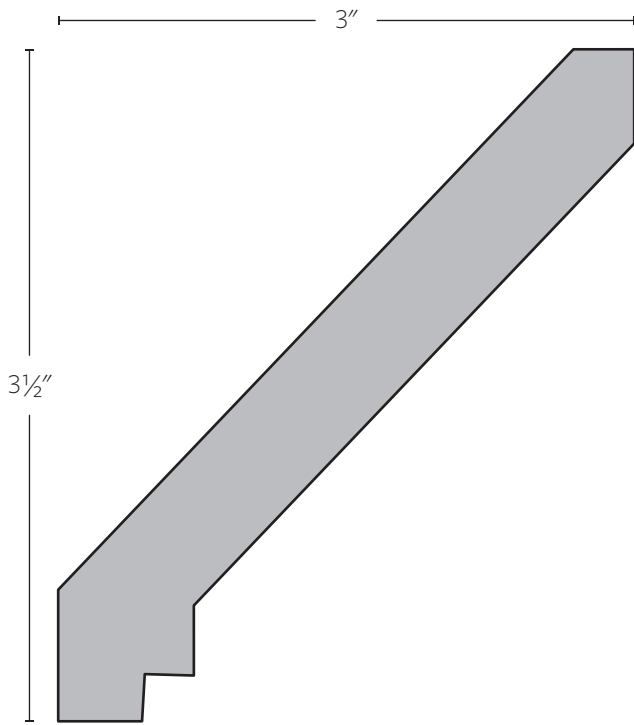

SWD 5045 | $1\frac{3}{16}'' \times 4\frac{9}{16}''$ | 45/45

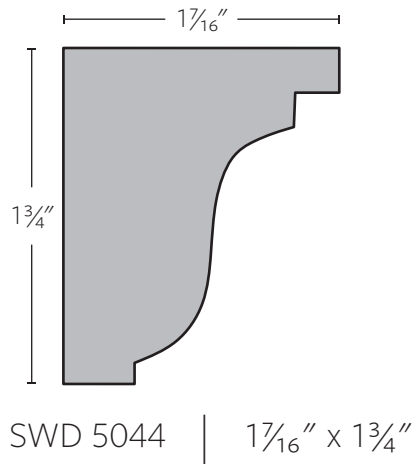

SWD 5044 | $1\frac{7}{16}'' \times 1\frac{3}{4}''$

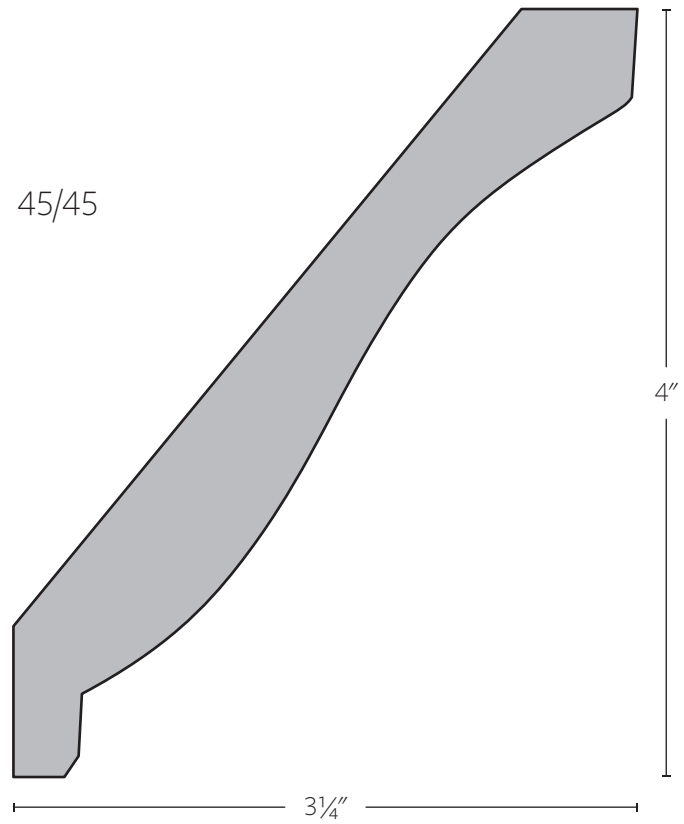

SWD 5046 | $\frac{3}{4}'' \times 5\frac{1}{4}''$ | 38/52

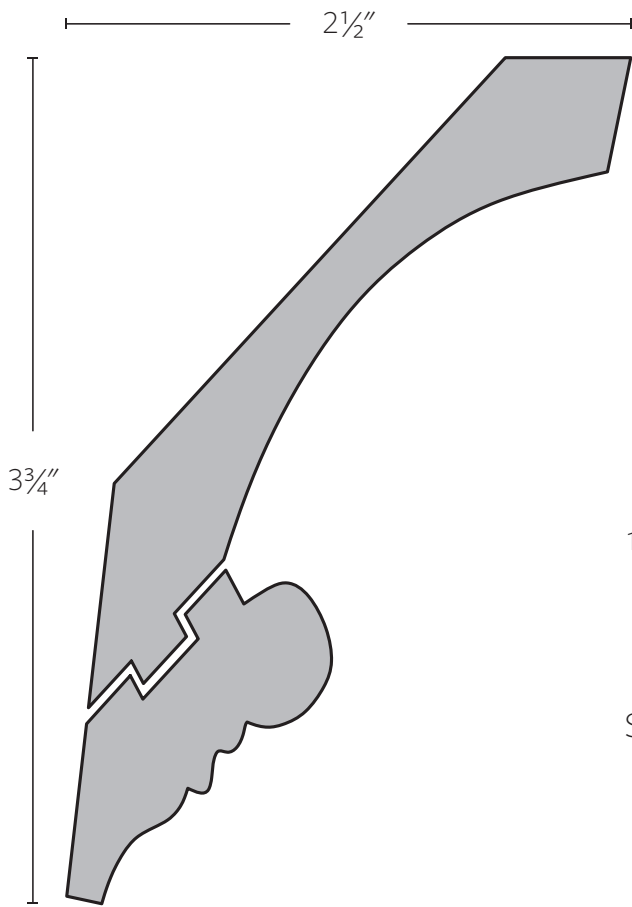

SWD 5047 | $1\frac{3}{16}'' \times 4''$ | $\frac{3}{4}'' \times 1\frac{13}{16}''$

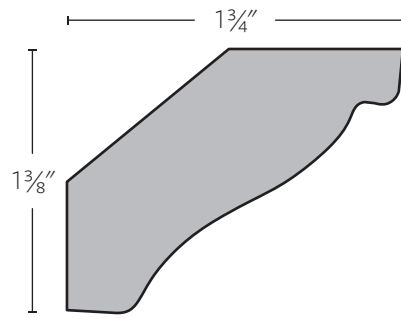

SWD 5048 | $\frac{3}{4}'' \times 2\frac{1}{4}''$ | 38/52

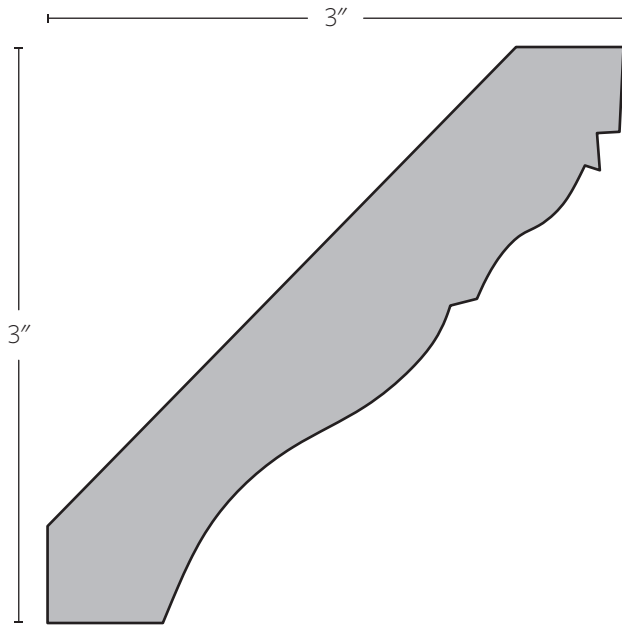

SWD 5049 | $\frac{3}{4}'' \times 4\frac{1}{16}''$ | 45/45

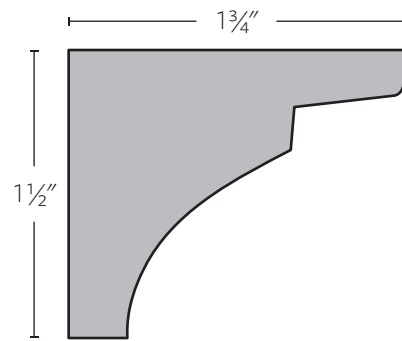

SWD 5050 | $1\frac{1}{2}'' \times 1\frac{3}{4}''$

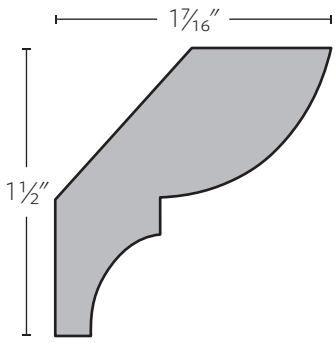

SWD 5051 | $1\frac{7}{16}'' \times 2\frac{1}{16}''$ | 45/45

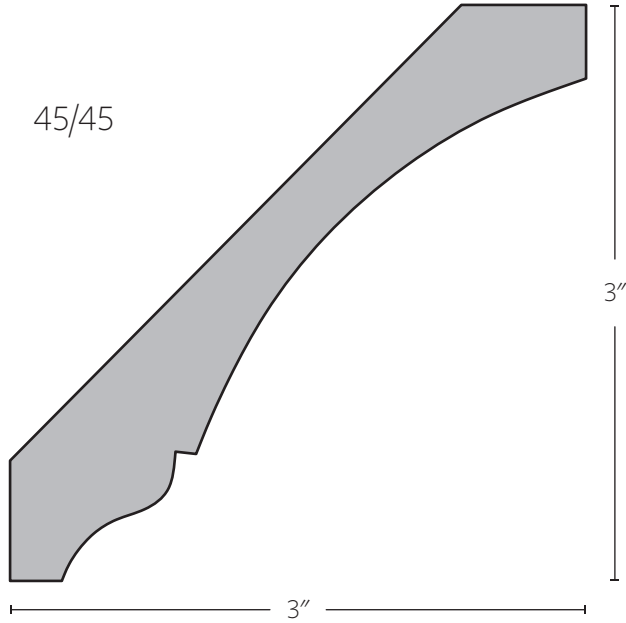

SWD 5052 | $\frac{3}{4}'' \times 4\frac{3}{8}''$ | 45/45

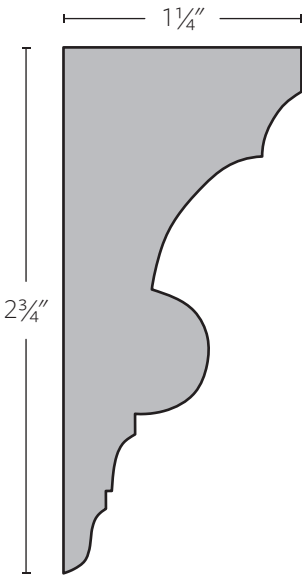

SWD 5053 | $1\frac{1}{4}'' \times 2\frac{3}{4}''$

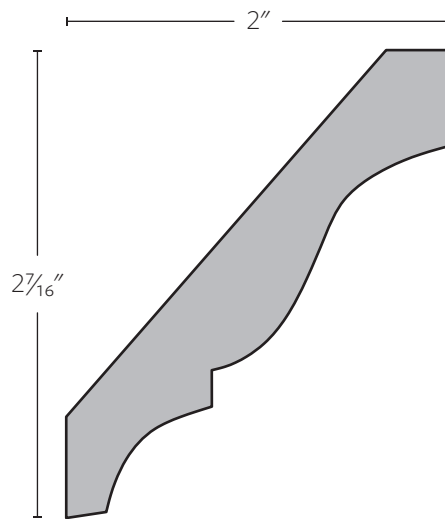

SWD 5054 | $\frac{9}{16}'' \times 3\frac{3}{16}''$ | 38/52

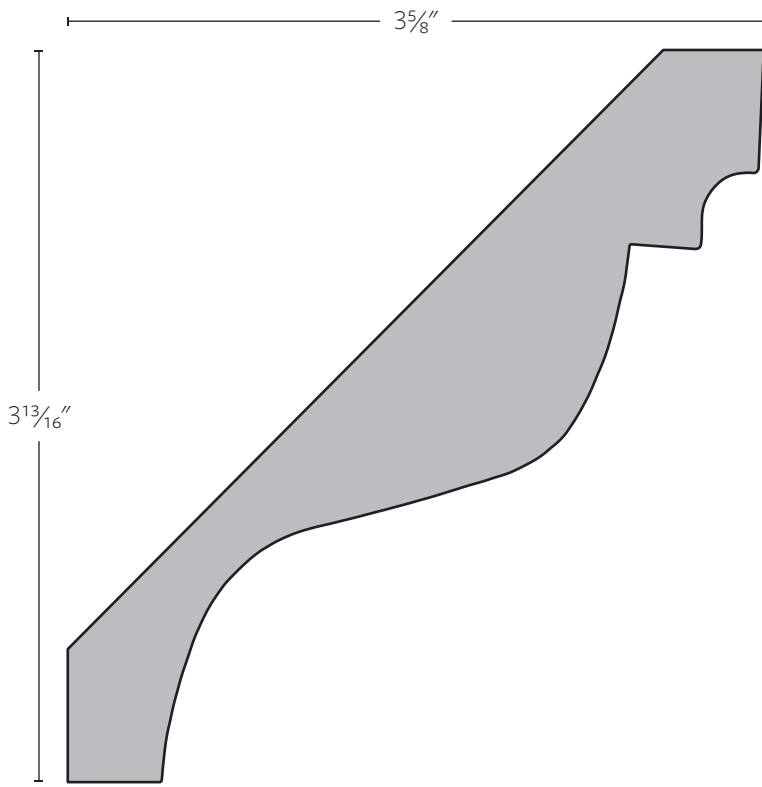

SWD 5055 | 1 1/16" x 5 1/4" | 45/45

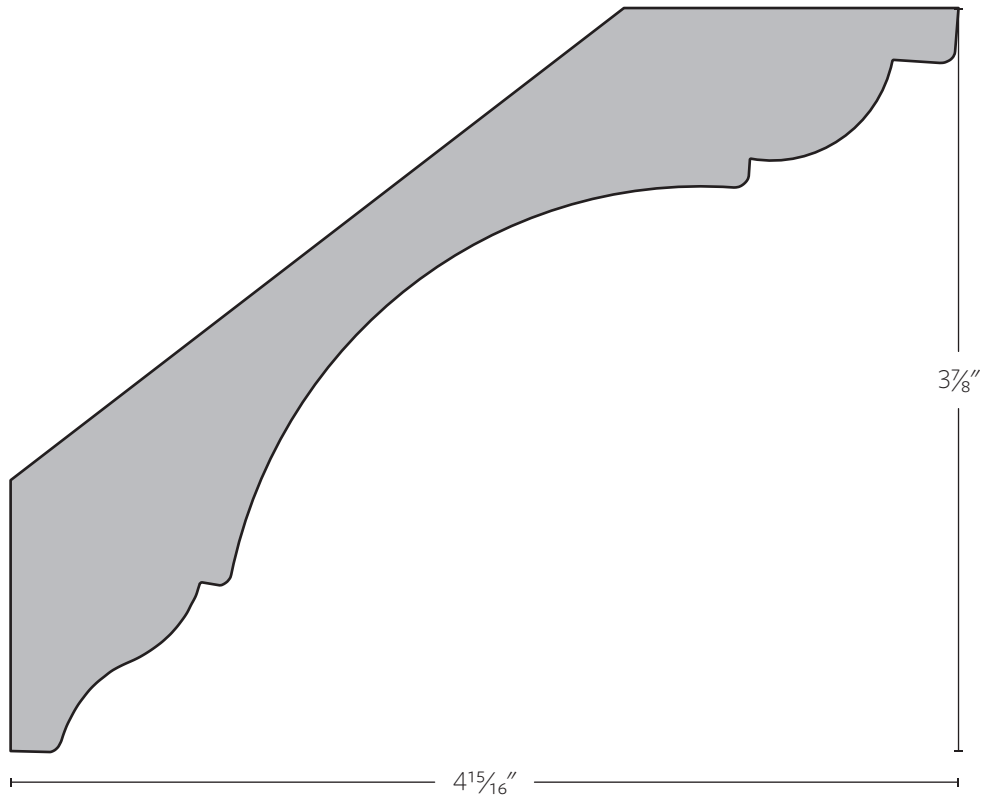

SWD 5056 | 1 1/4" x 6 1/4" | 38/52

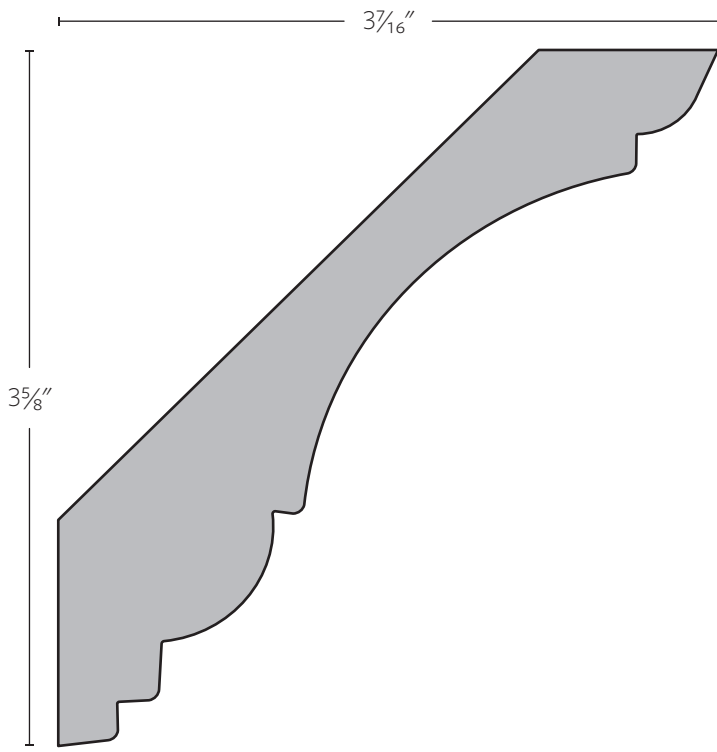

SWD 5057 | 1" x 4 15/16" | 45/45

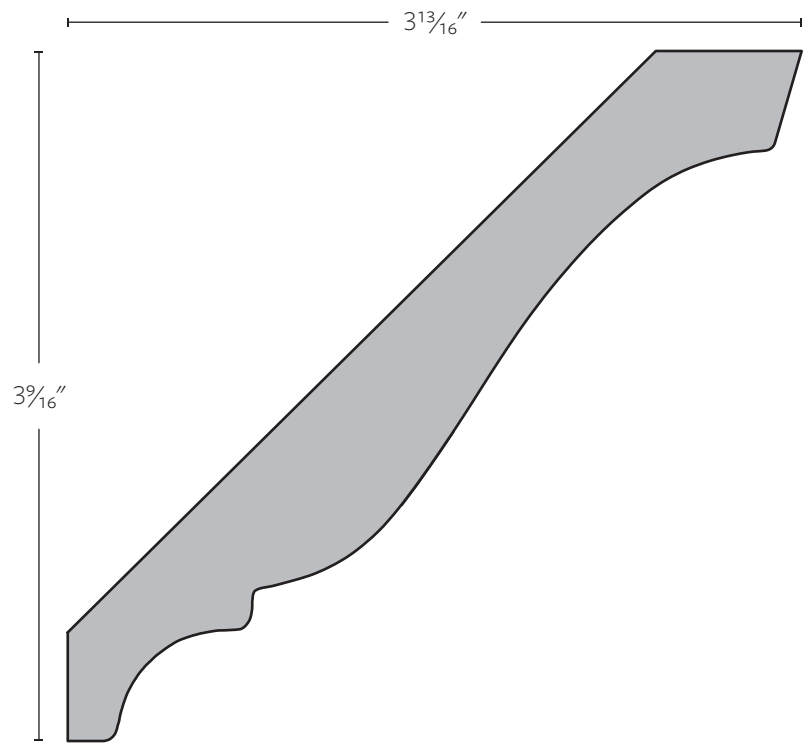

SWD 5058 | 3/4" x 5 1/8" | 45/45

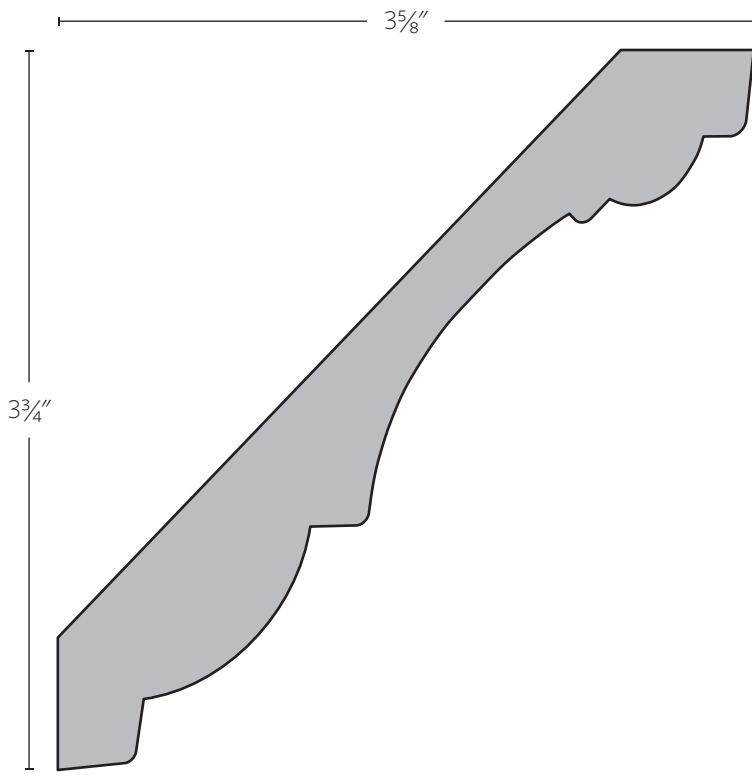

SWD 5059 | $\frac{3}{4}'' \times 5\frac{1}{4}''$ | 45/45

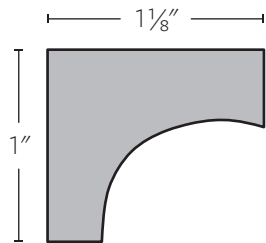

SWD 5060 | $1\frac{1}{8}'' \times 1''$

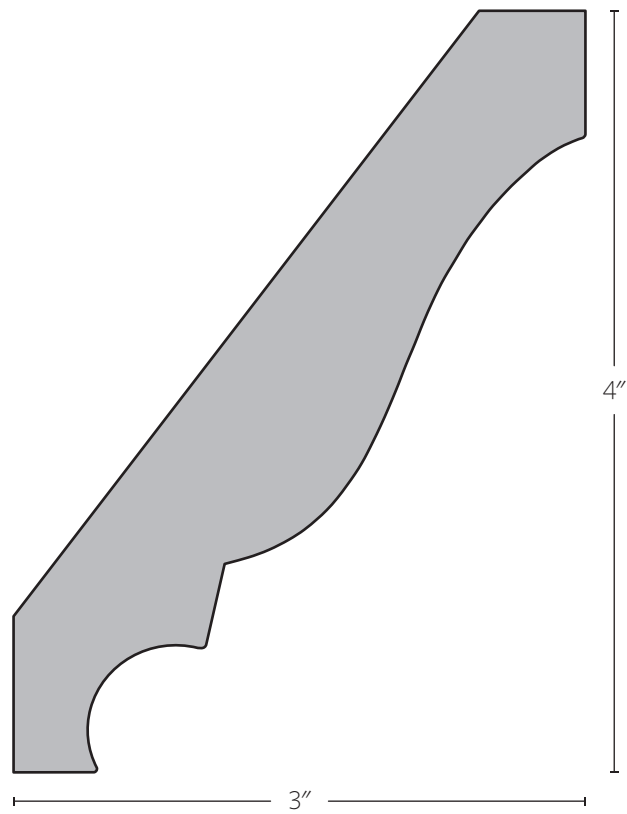

SWD 5061 | $1\frac{3}{16}'' \times 5''$ | 38/52

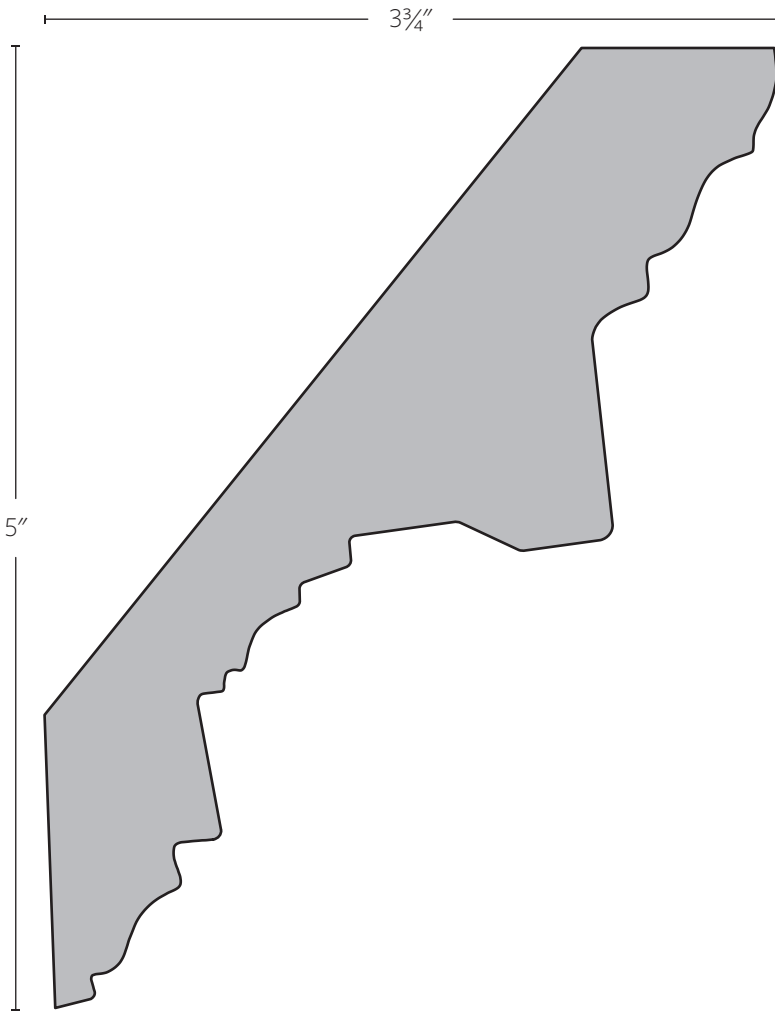

SWD 5062 | $1\frac{5}{8}'' \times 6\frac{1}{4}''$ | 38/52

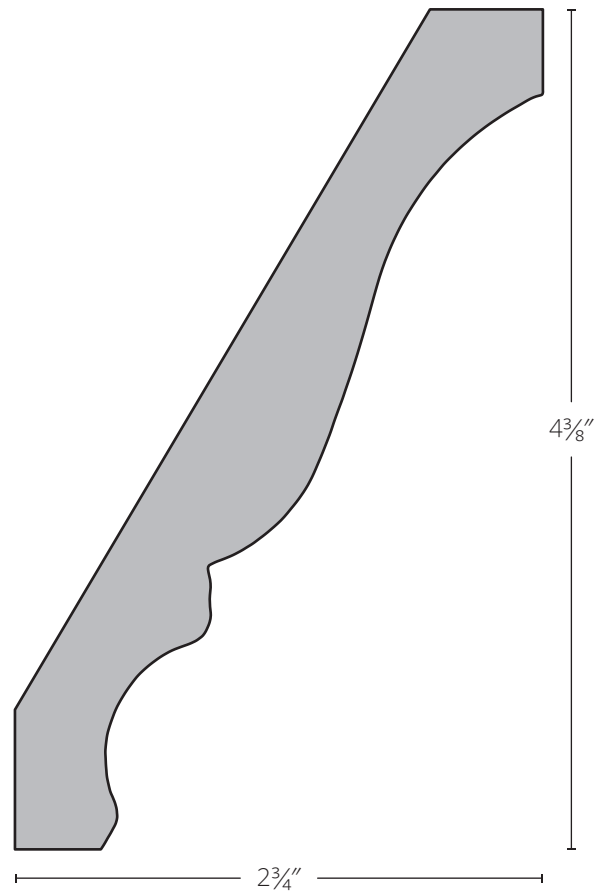

SWD 5063 | $\frac{3}{4}'' \times 5\frac{1}{8}''$ | 30/60

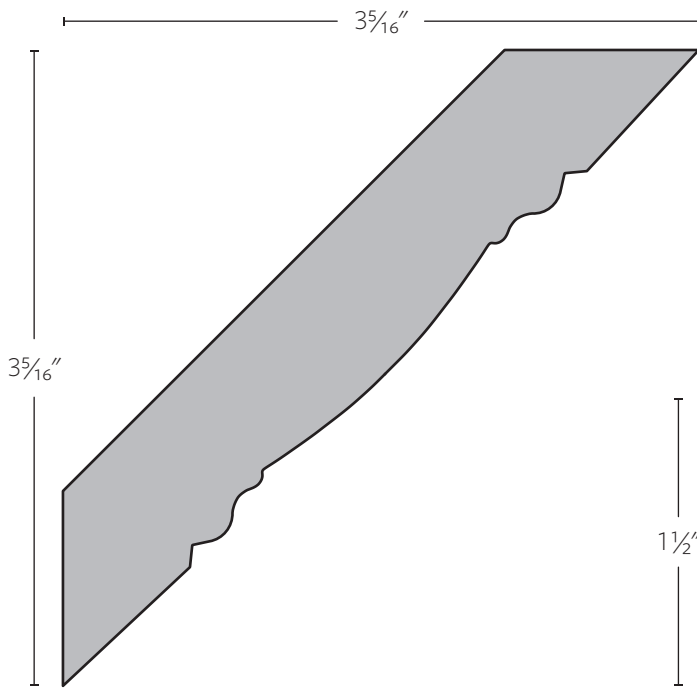

SWD 5064 | 3/4" x 4 3/4" | 45/45

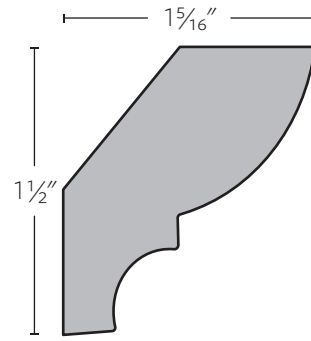

SWD 5065 | 3/4" x 1 15/16" | 38/52

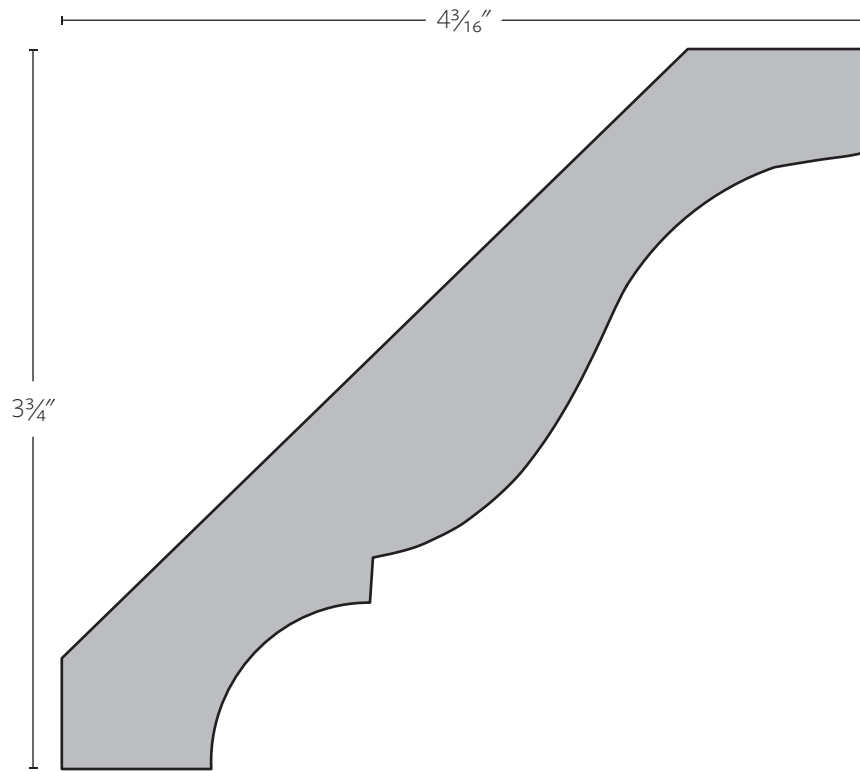

SWD 5066 | 1" x 5 5/8" | 45/45

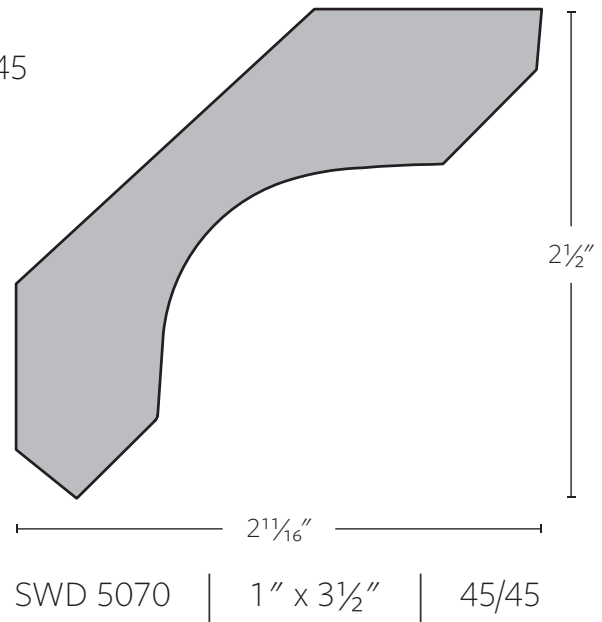
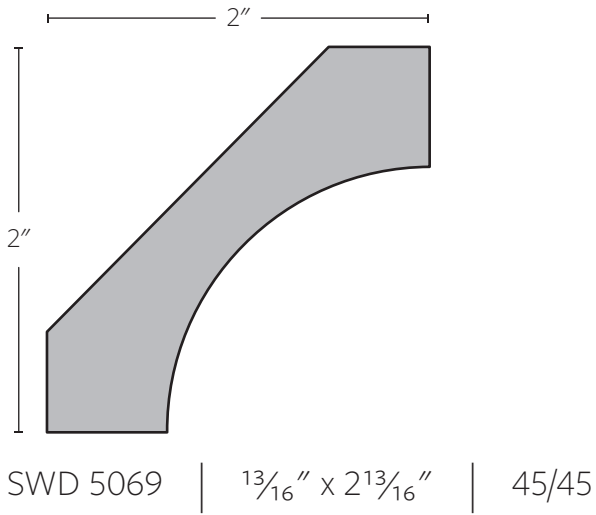
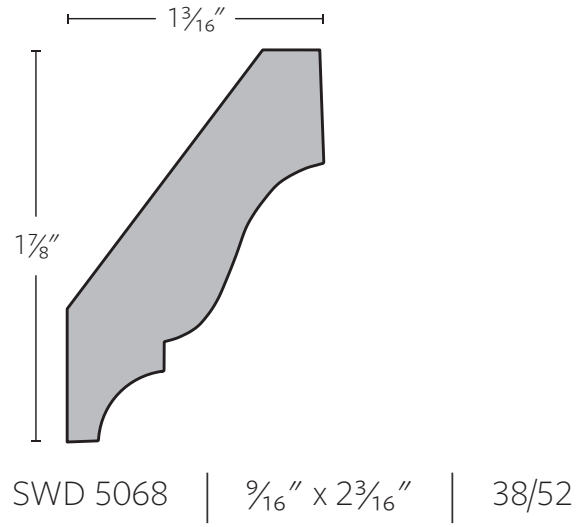
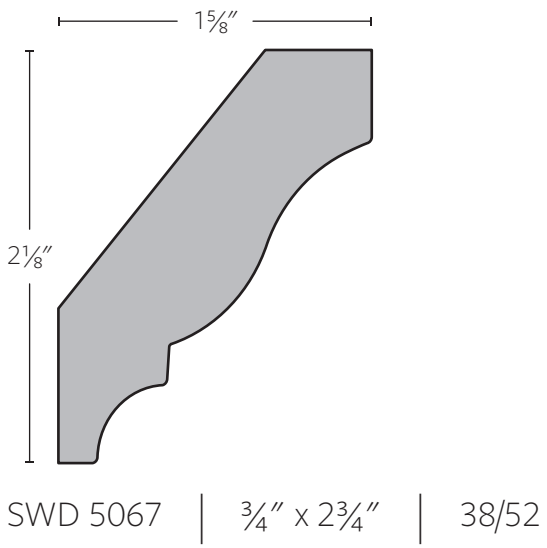

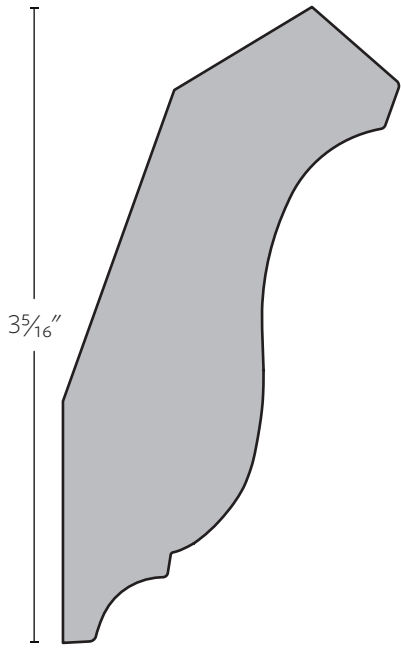

SWD 5071 | 1 1/8" x 3 5/8"

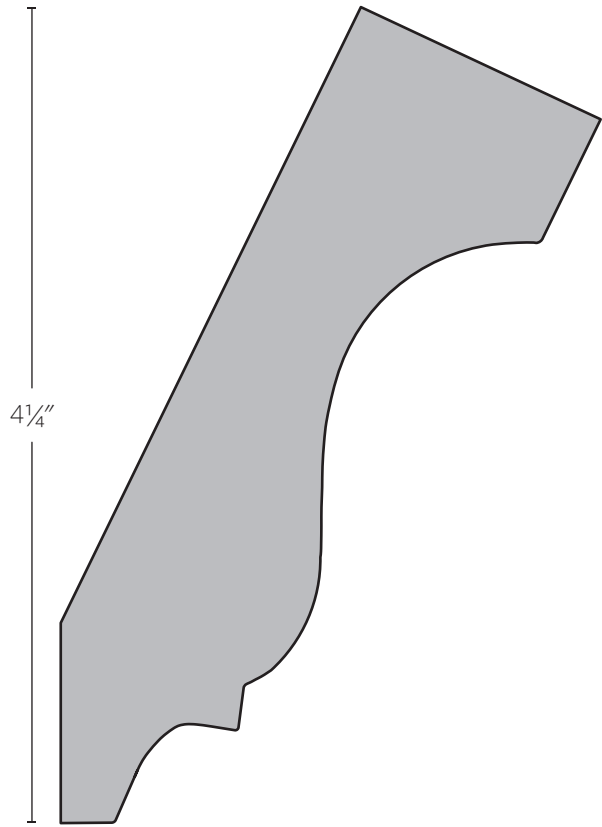

SWD 5072 | 1 5/16" x 4 1/2"

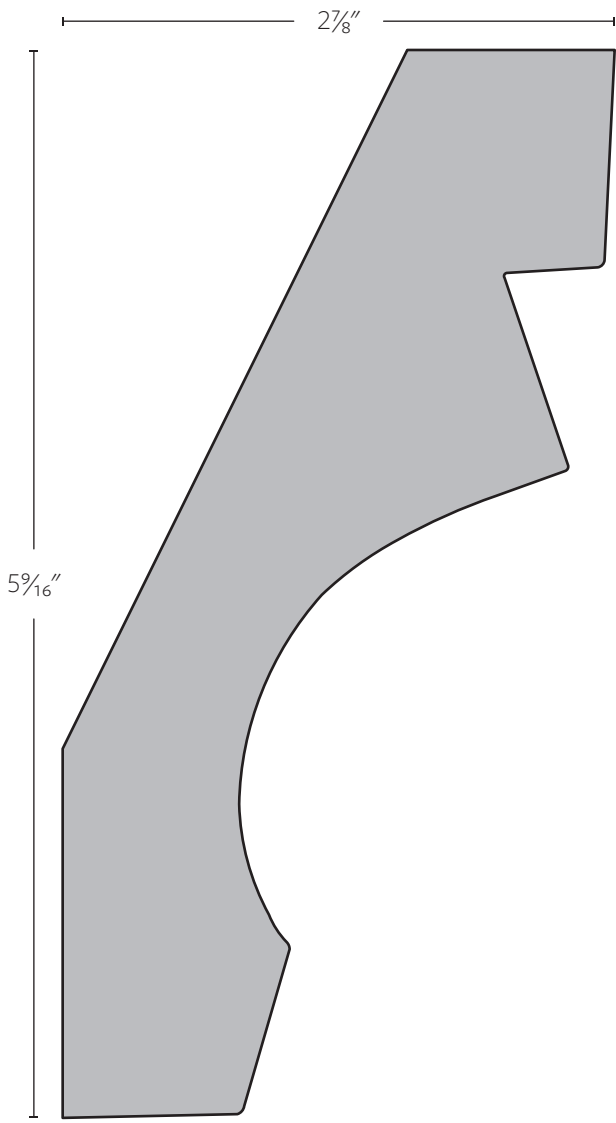

SWD 5073 | $1\frac{3}{4}$ " x $6\frac{1}{4}$ " | 30/60

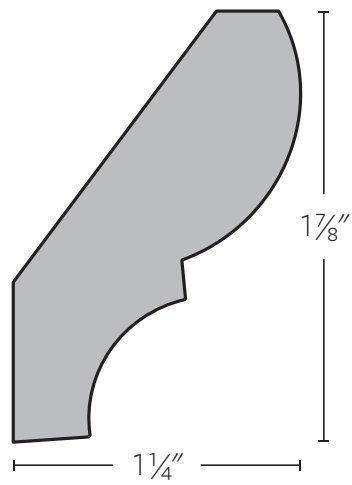

SWD 5074 | $1\frac{1}{16}$ " x $2\frac{1}{4}$ " | 38/52

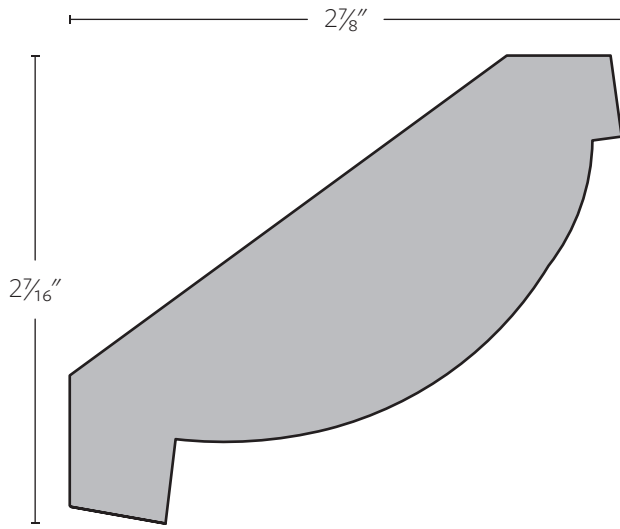

SWD 5075 | $1\frac{3}{16}$ " x $3\frac{3}{4}$ " | 38/52

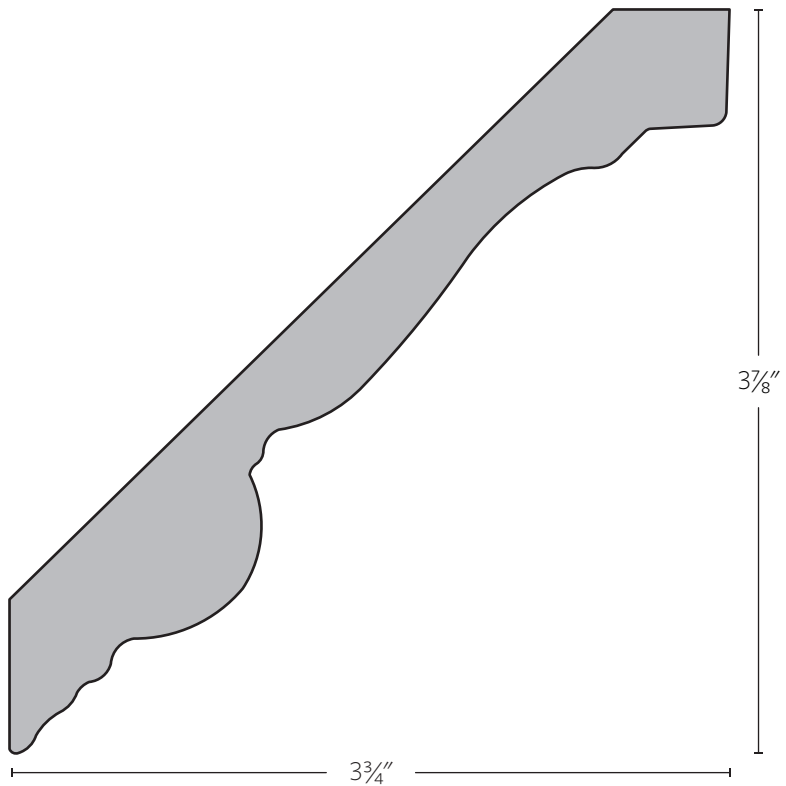

SWD 5076 | $1\frac{3}{16}$ " x $5\frac{3}{8}$ " | 45/45

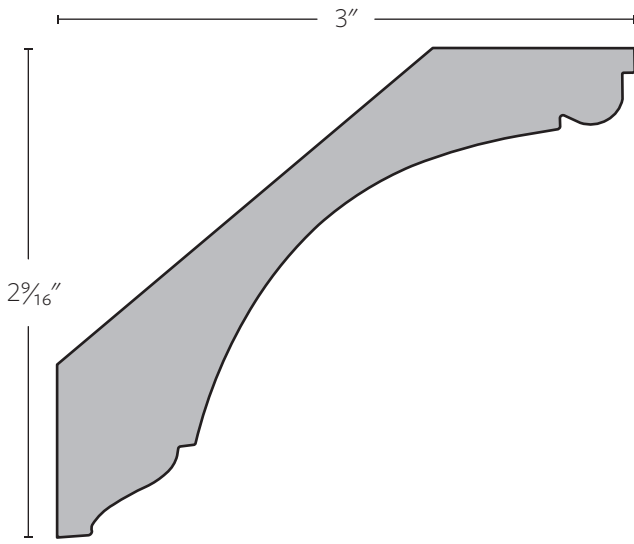

SWD 5077 | $\frac{7}{8}'' \times 3\frac{15}{16}''$ | 45/45

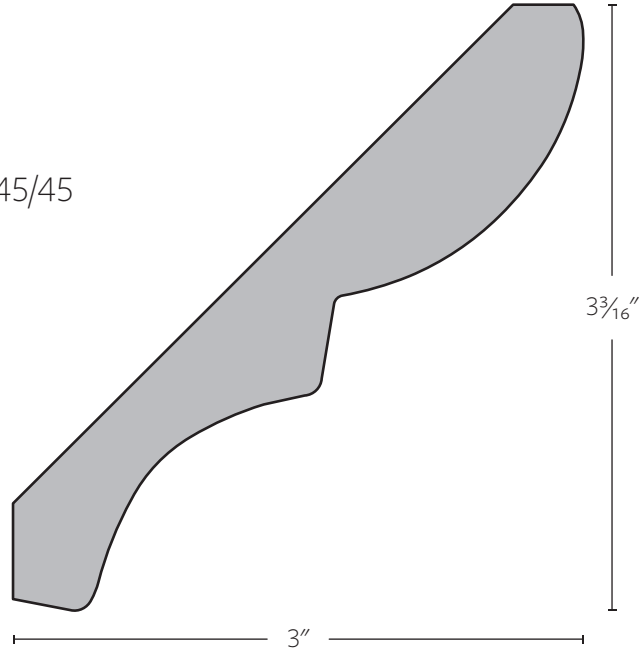

SWD 5078 | $\frac{3}{4}'' \times 4\frac{3}{8}''$ | 45/45

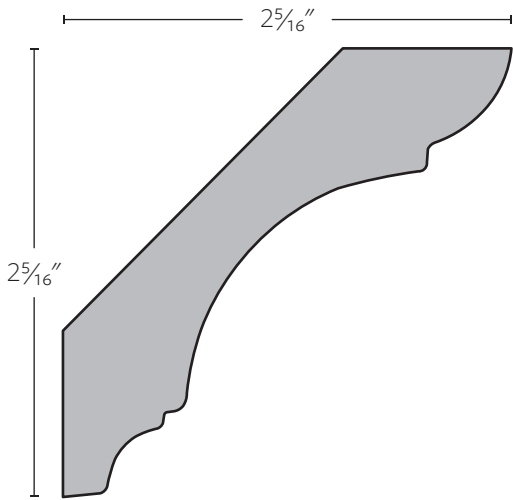

SWD 5079 | $\frac{3}{4}'' \times 3\frac{1}{4}''$ | 45/45

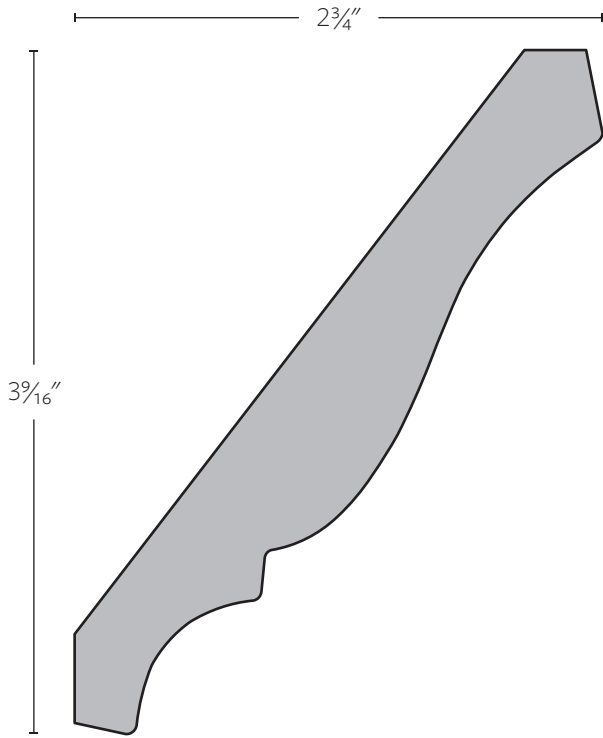

SWD 5080 | 3/4" x 4 1/2" | 38/52

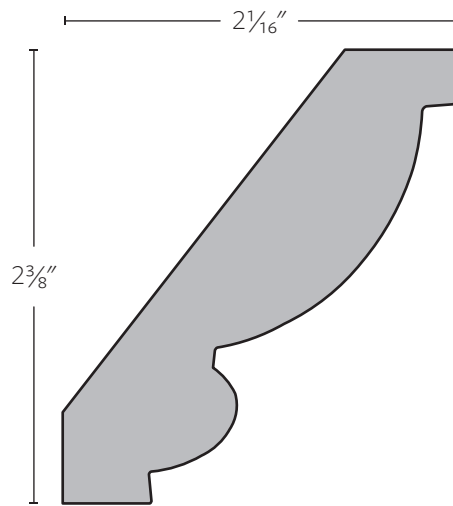

SWD 5081 | 3/4" x 3 1/8" | 38/52

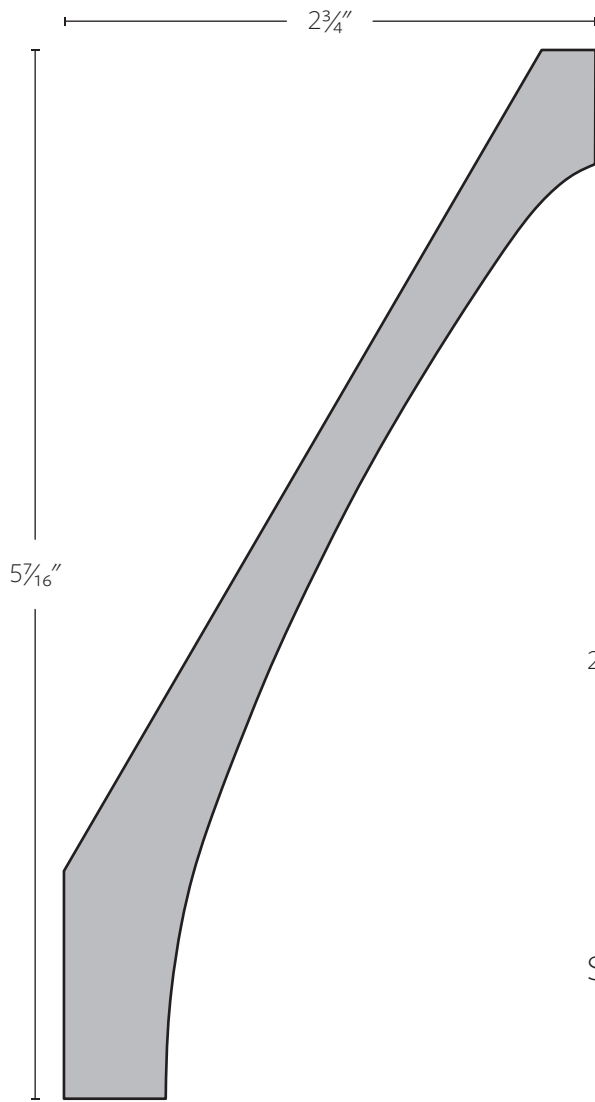

SWD 5082 | 1 1/8" x 6 1/8" | 30/60

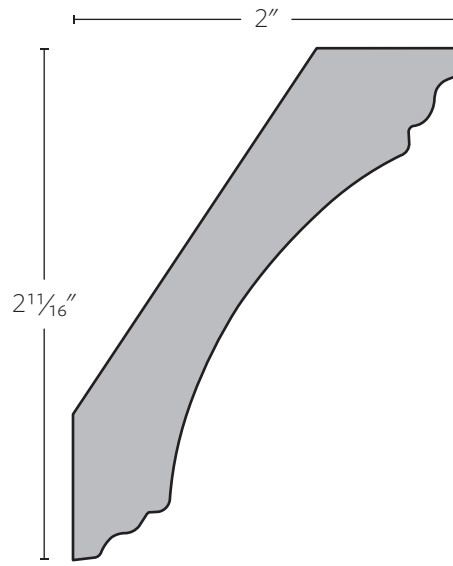

SWD 5083 | 1 1/16" x 3 5/16" | 30/60

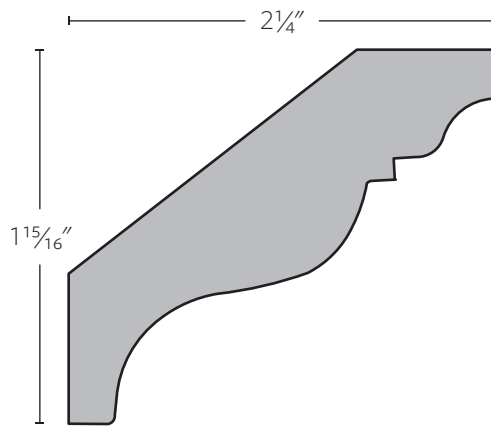

SWD 5084 | 3/4" x 2 15/16" | 38/52

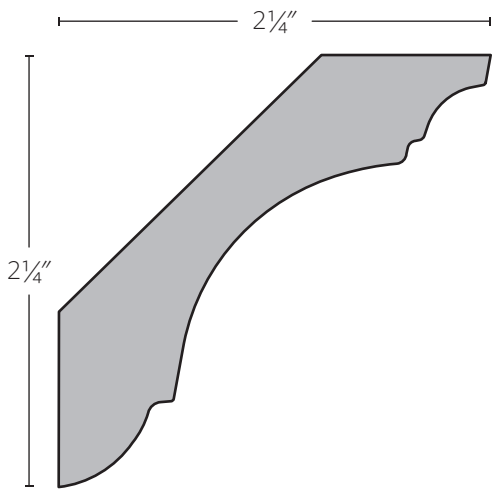

SWD 5085 | $\frac{3}{4}'' \times 3\frac{1}{4}''$ | 45/45

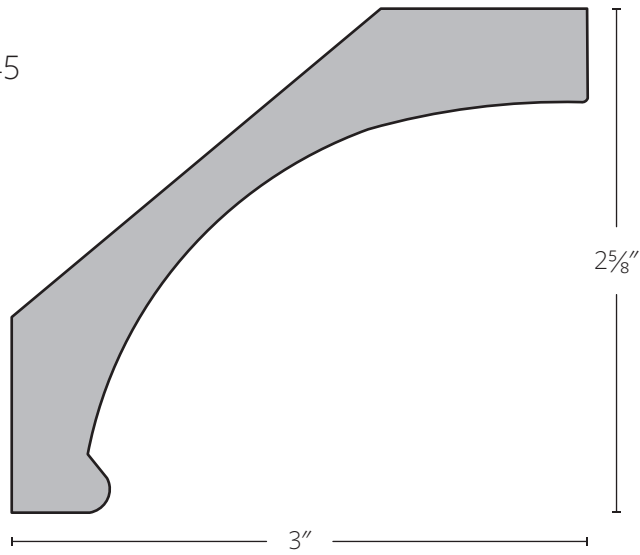

SWD 5086 | $1\frac{1}{16}'' \times 4''$ | 38/52

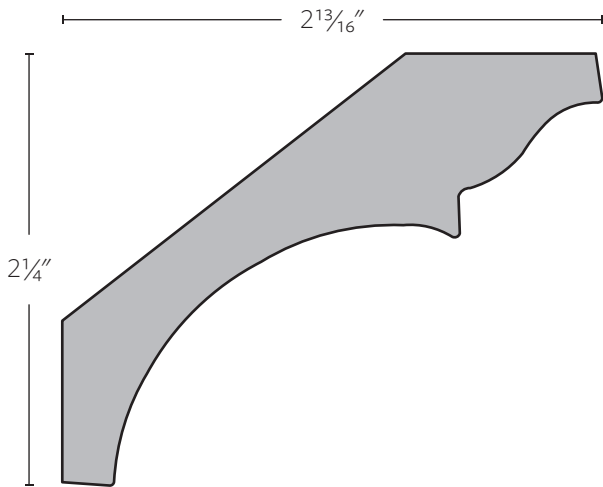

SWD 5087 | $1\frac{5}{16}'' \times 3\frac{5}{8}''$ | 38/52

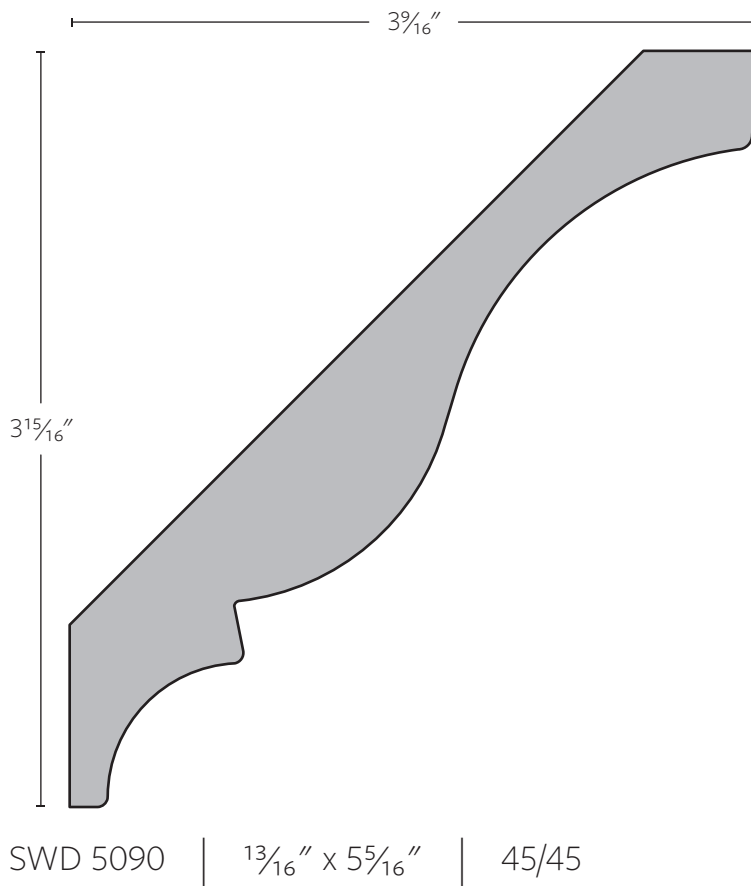
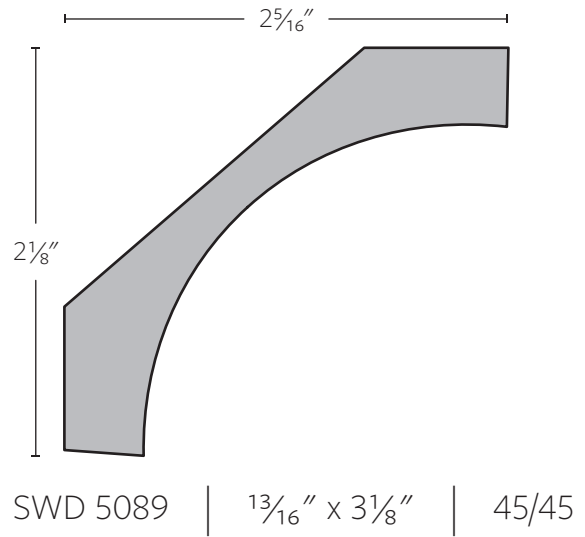
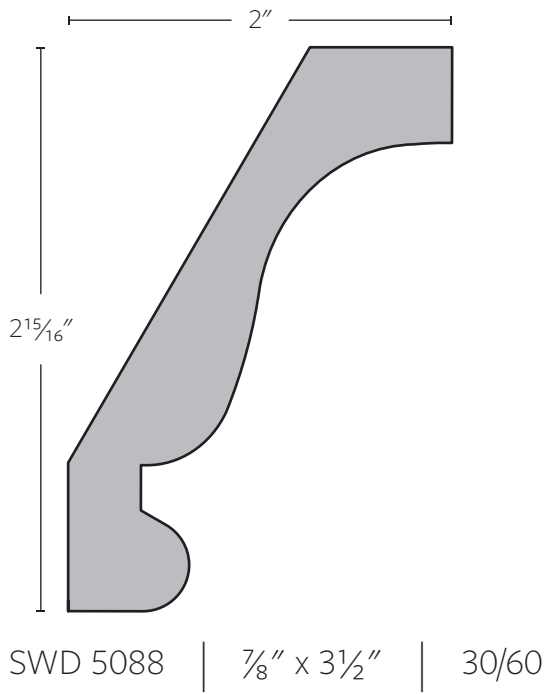

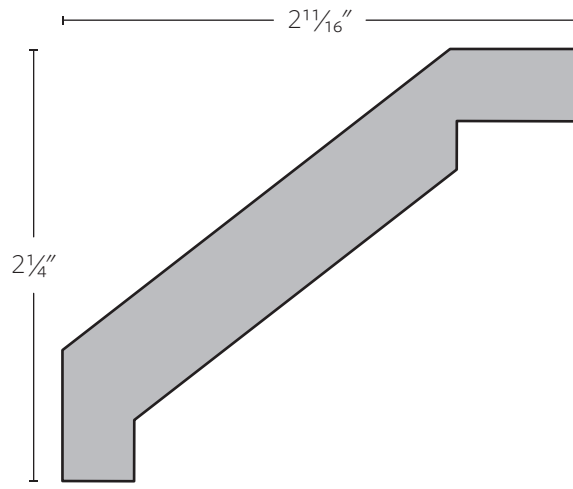

SWD 5091 | 3/4" x 3 1/2" | 38/52

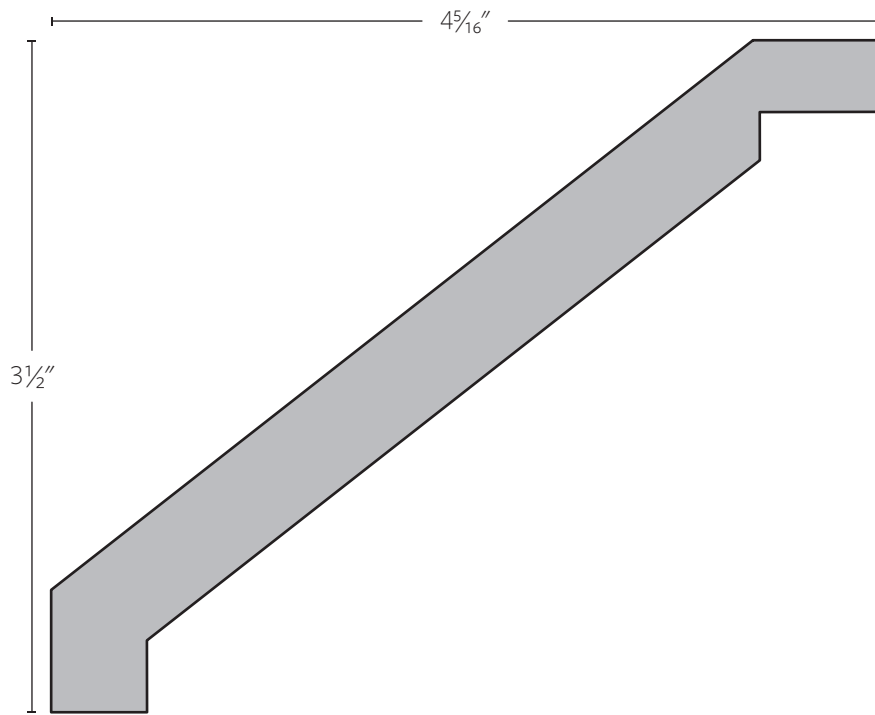

SWD 5092 | 3/4" x 5 1/2" | 38/52

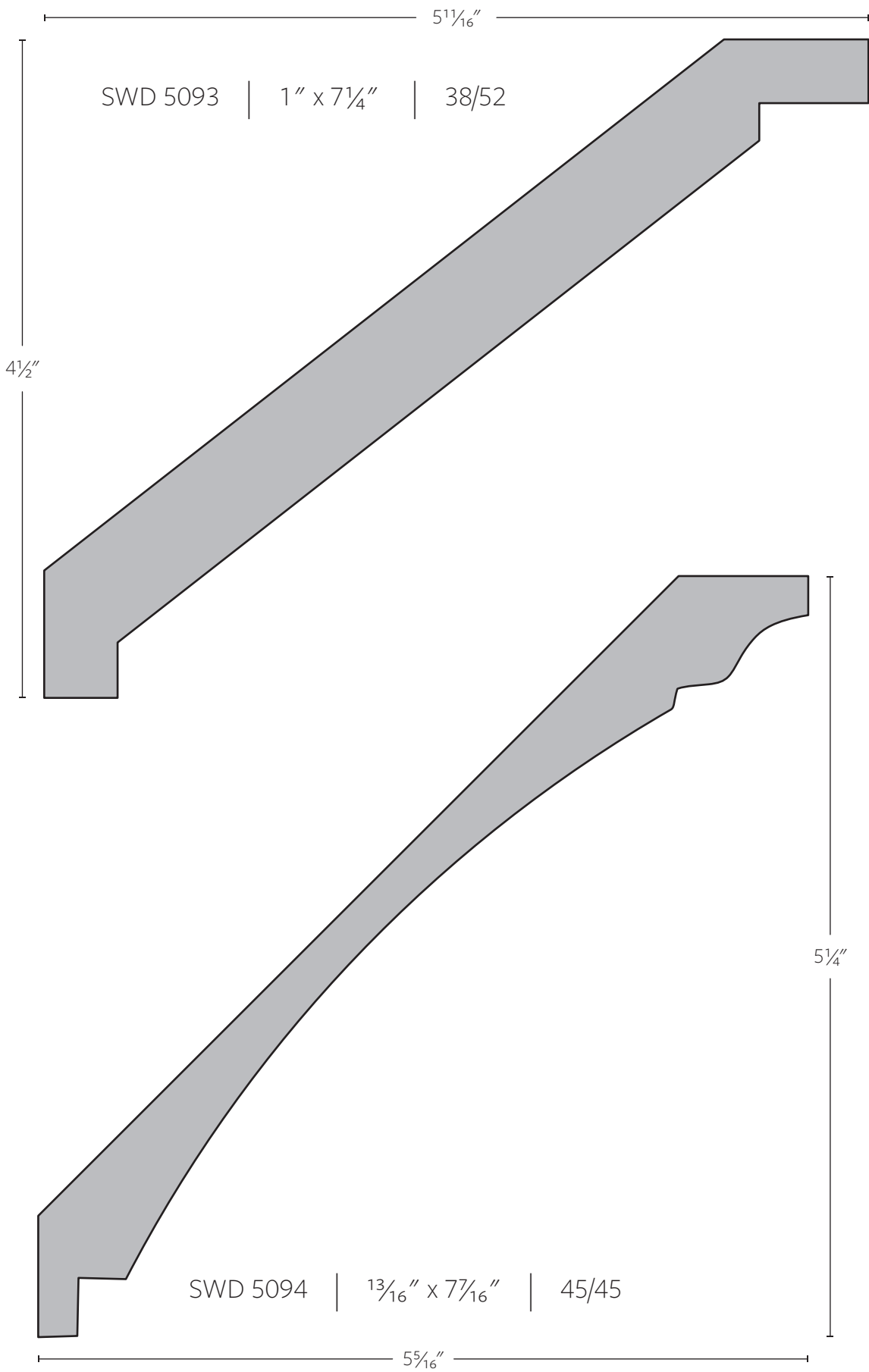

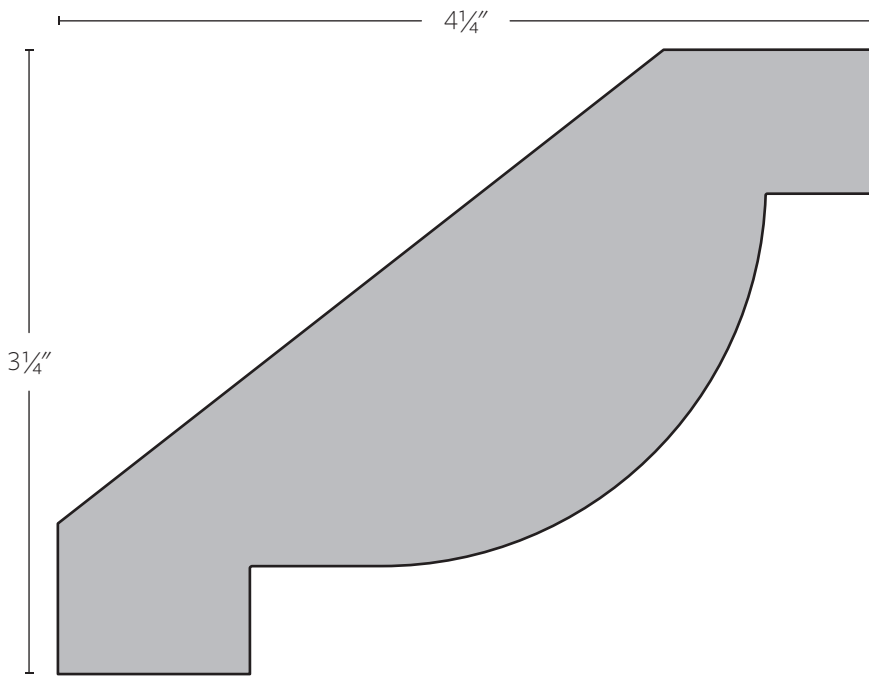

SWD 5095 | $1\frac{5}{8}'' \times 5\frac{3}{8}''$ | 38/52

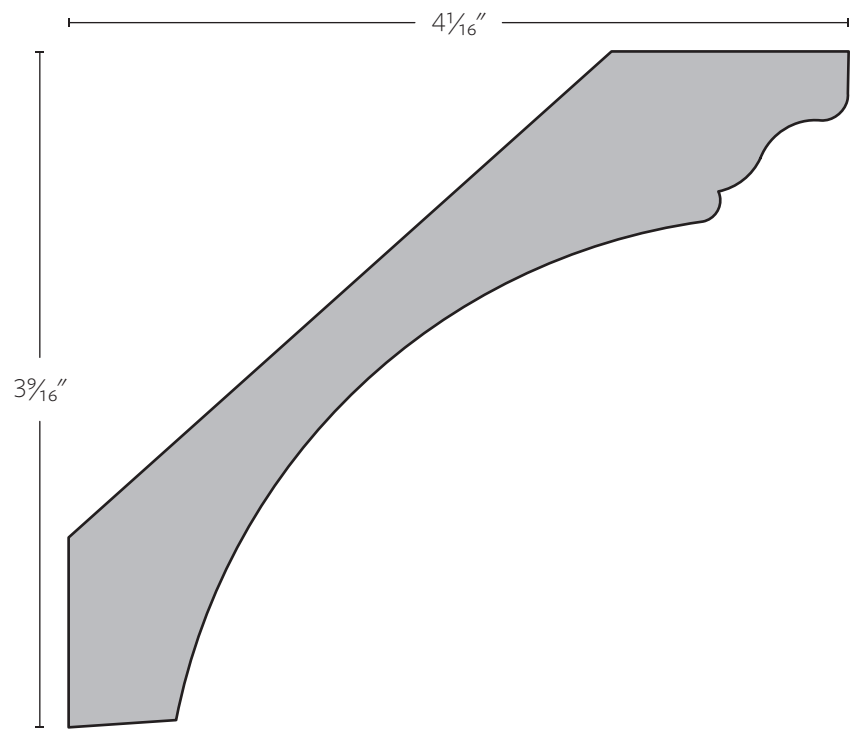

SWD 5096 | $1\frac{1}{16}'' \times 5\frac{3}{8}''$ | 45/45

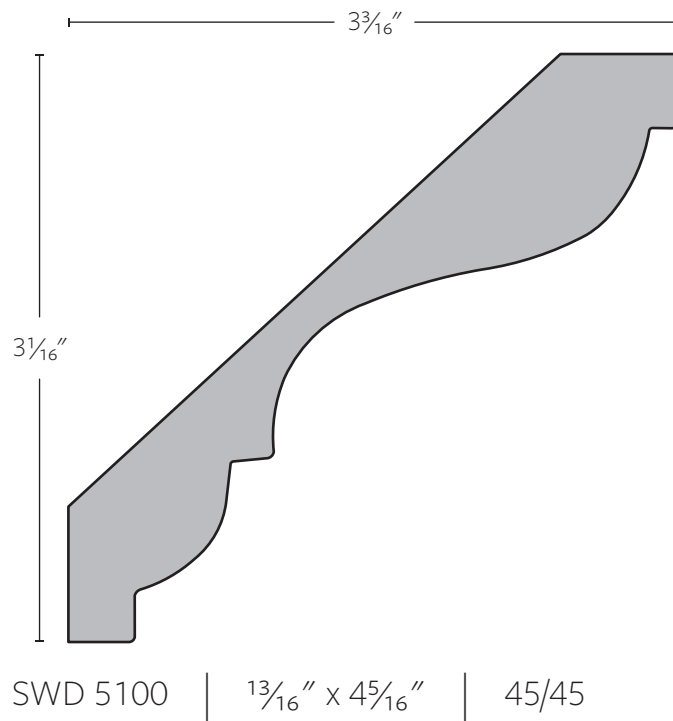
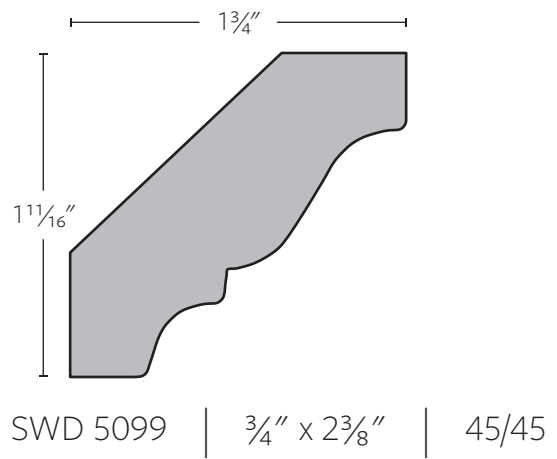
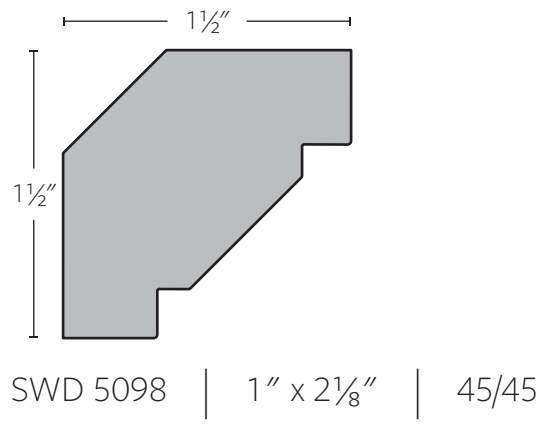
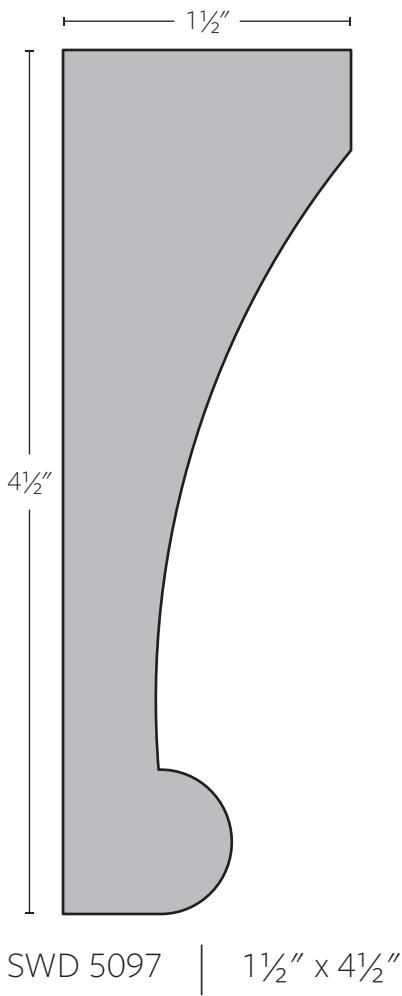

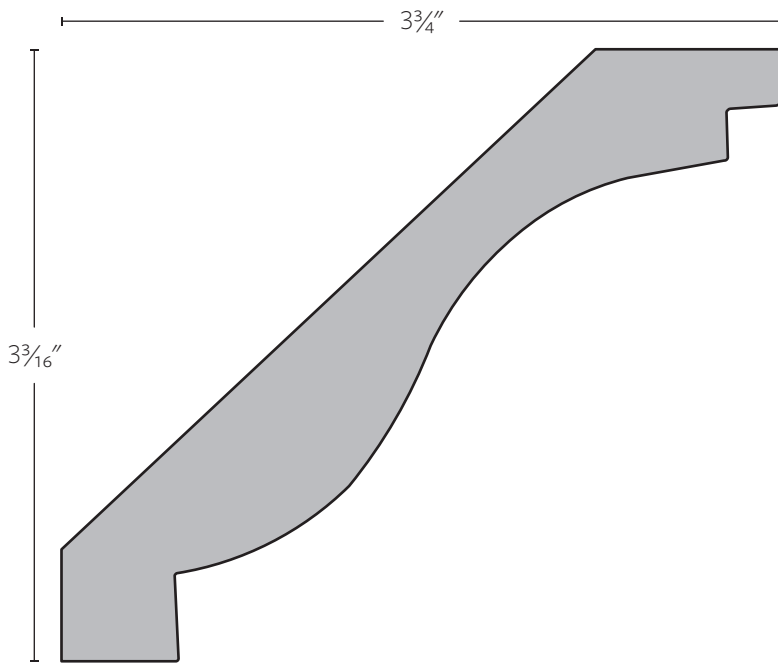

SWD 5101 | $1\frac{3}{16}'' \times 4\frac{7}{8}''$ | 45/45

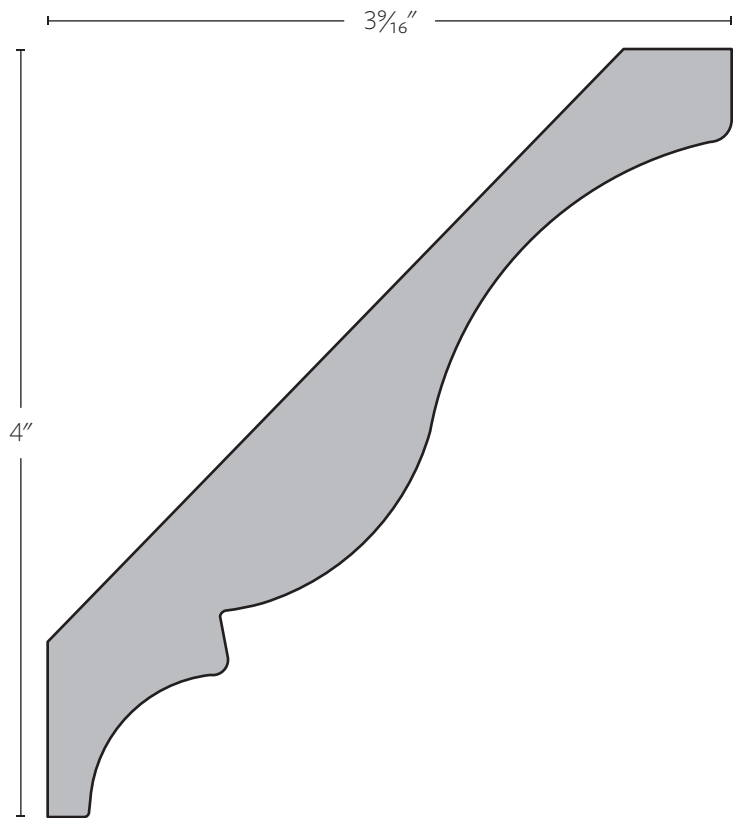

SWD 5102 | $1\frac{3}{16}'' \times 5\frac{3}{8}''$ | 45/45

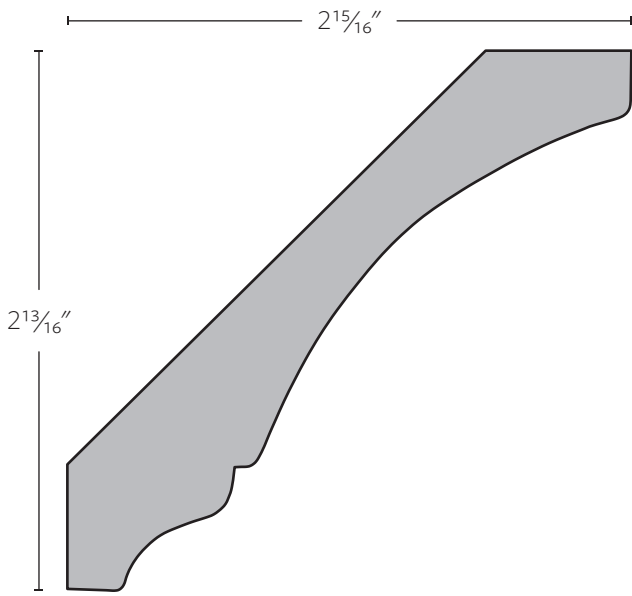

SWD 5103 | $\frac{3}{4}'' \times 4\frac{1}{16}''$ | 45/45

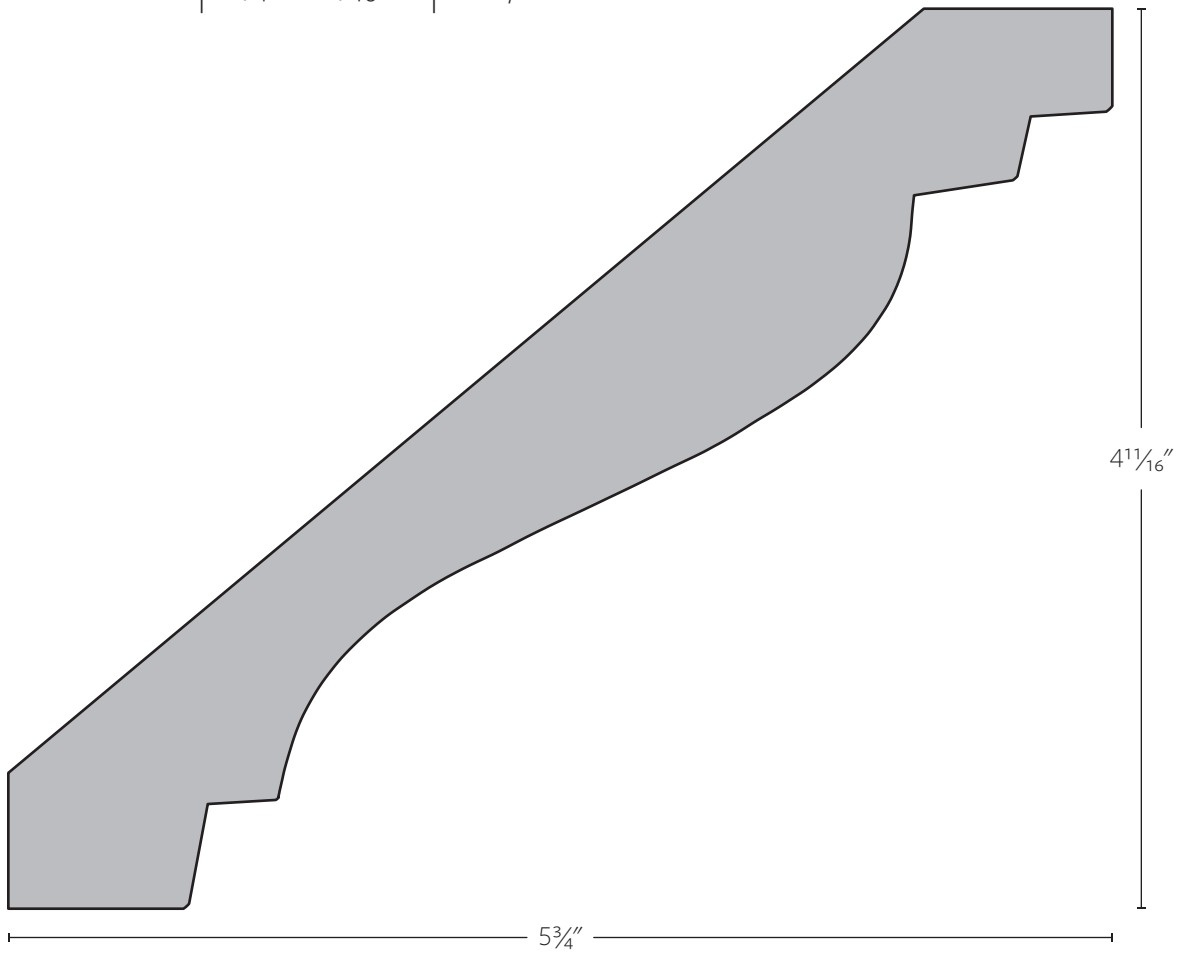

SWD 5104 | $1\frac{1}{8}'' \times 7\frac{7}{16}''$ | 38/52

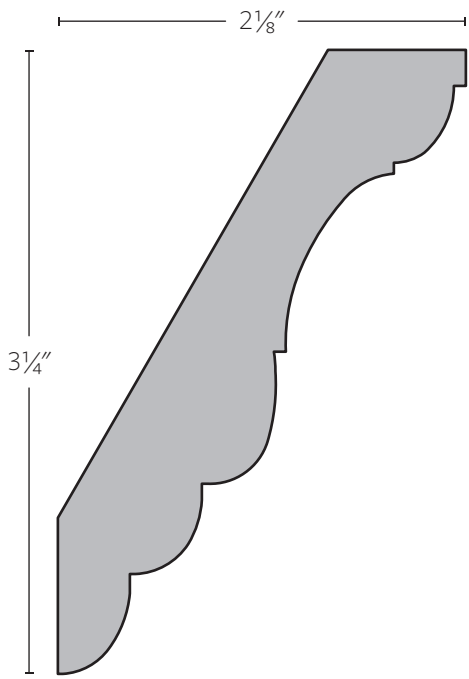

SWD 5105 | $\frac{3}{4}'' \times \frac{3}{8}''$ | 30/60

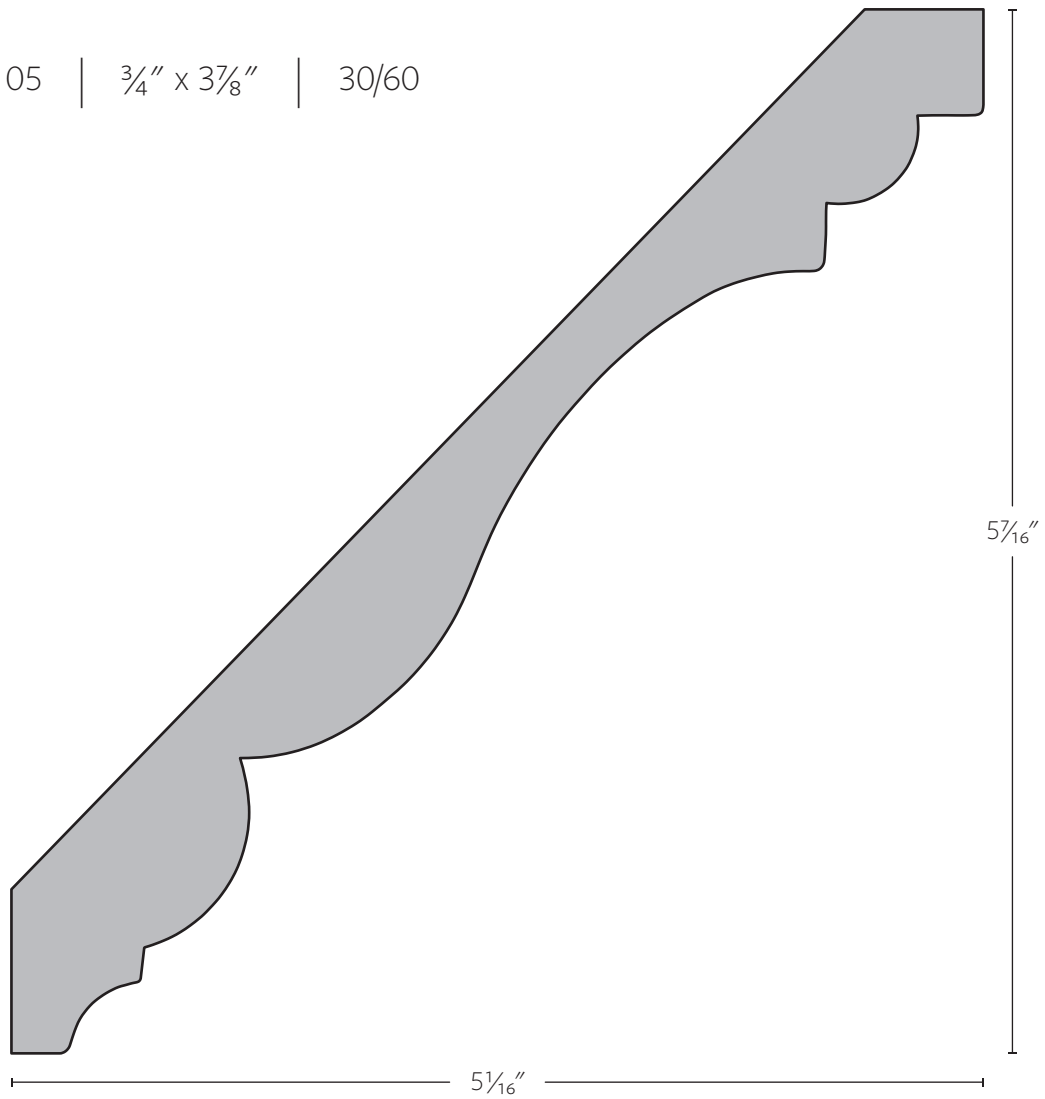

SWD 5106 | $1\frac{3}{16}'' \times 7\frac{1}{2}''$ | 38/52

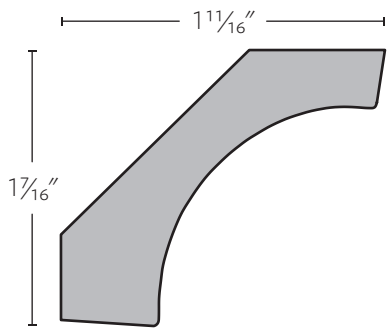

SWD 5107 | 3/4" x 2 1/4" | 45/45

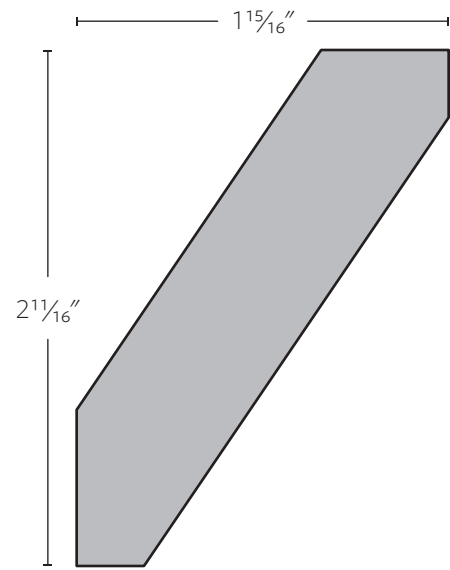

SWD 5108 | 3/4" x Customer Specs | 38/52

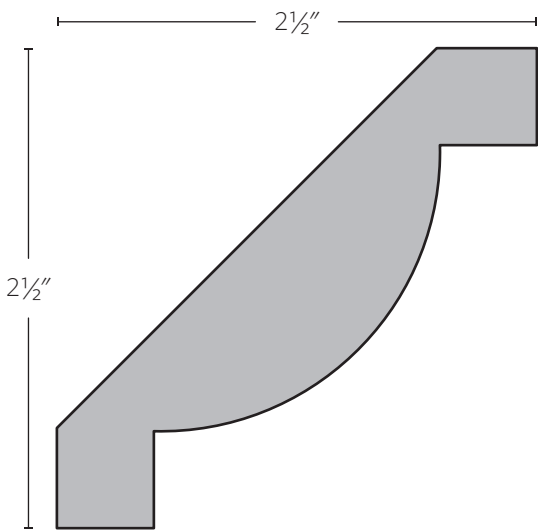

SWD 5109 | 1 3/16" x 3 1/2" | 45/45

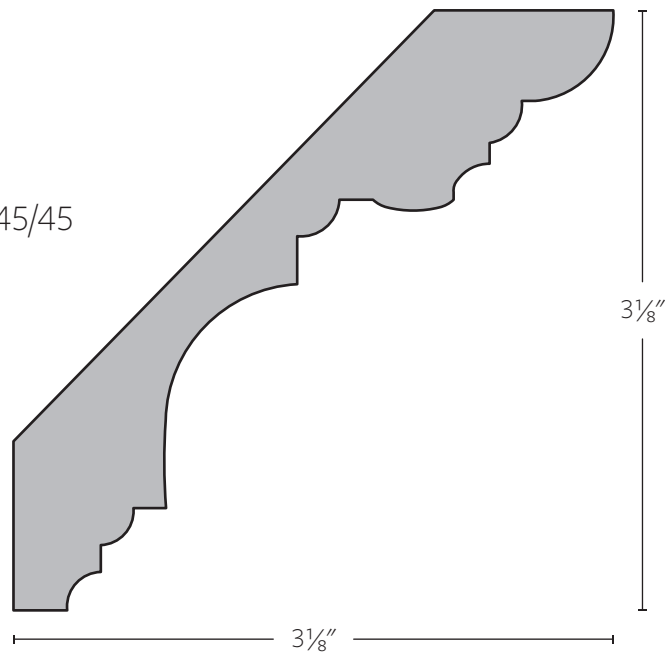

SWD 5110 | 1 3/16" x 4 27/64" | 45/45

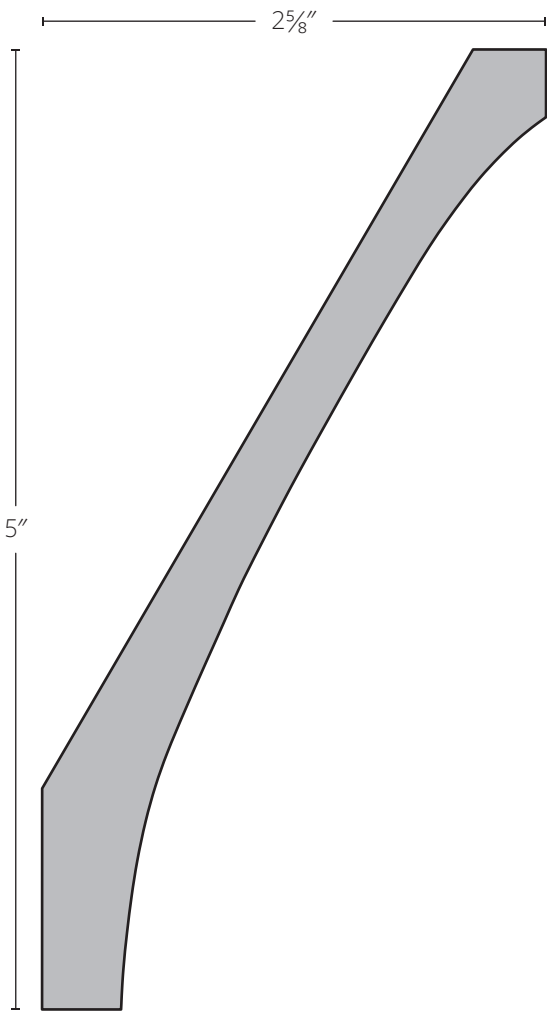

SWD 5111 | 1" x 5 5/8" | 30/60

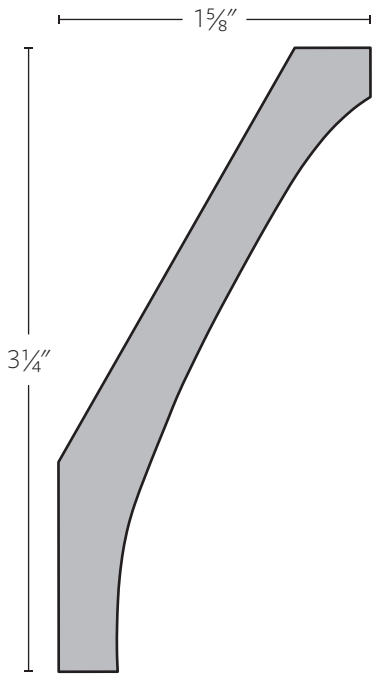

SWD 5112 | 1 3/16" x 3 5/8" | 30/60

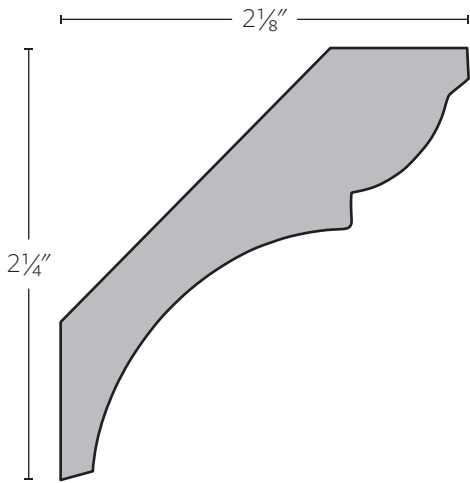

SWD 5113 | 3/4" x 3" | 45/45

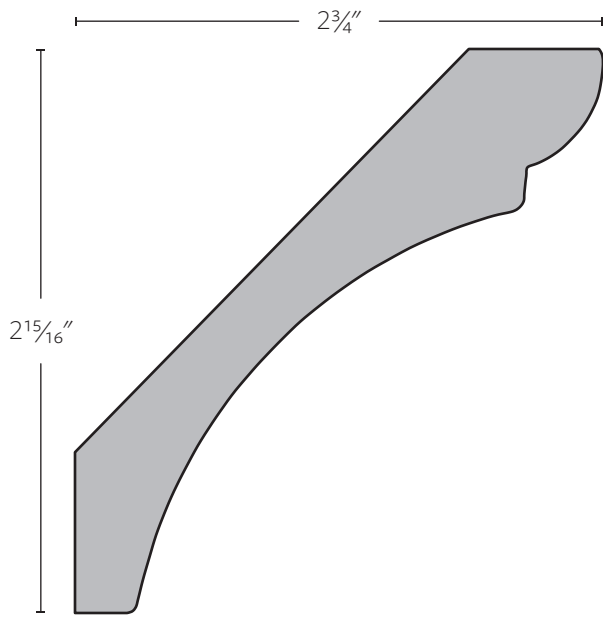

SWD 5114 | 1 3/16" x 4" | 45/45

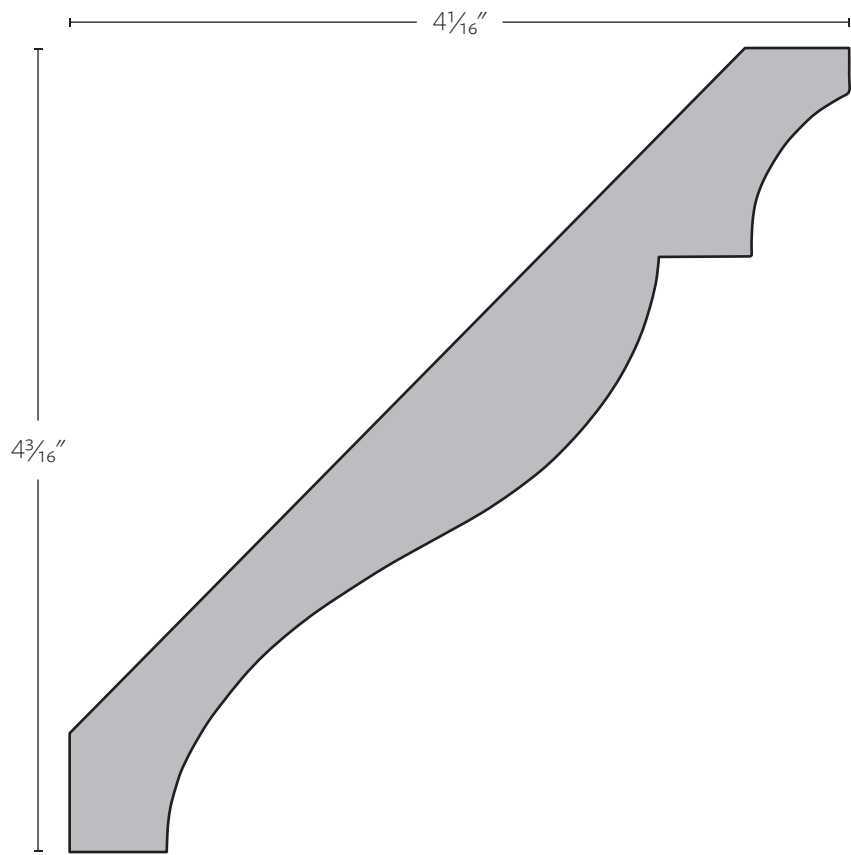

SWD 5115 | 1 3/16" x 5 7/8" | 45/45

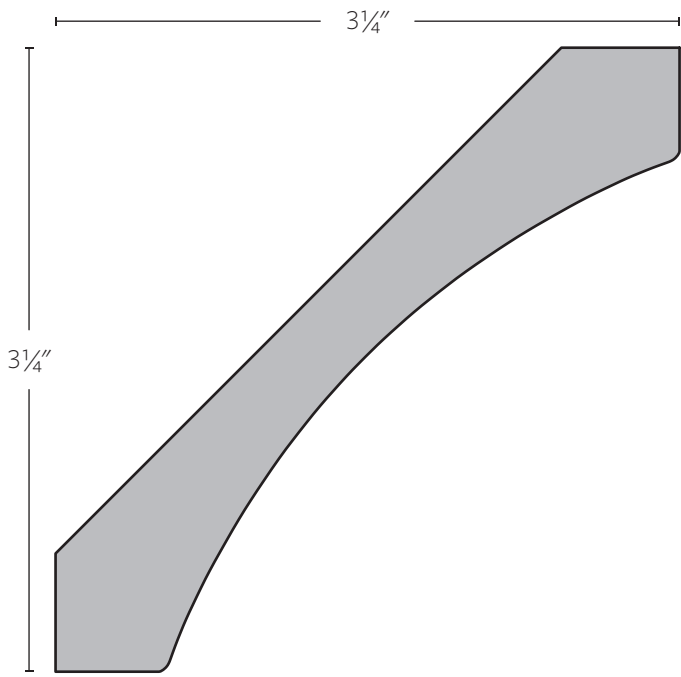

SWD 5116 | $1\frac{3}{16}'' \times 4\frac{9}{16}''$ | 45/45

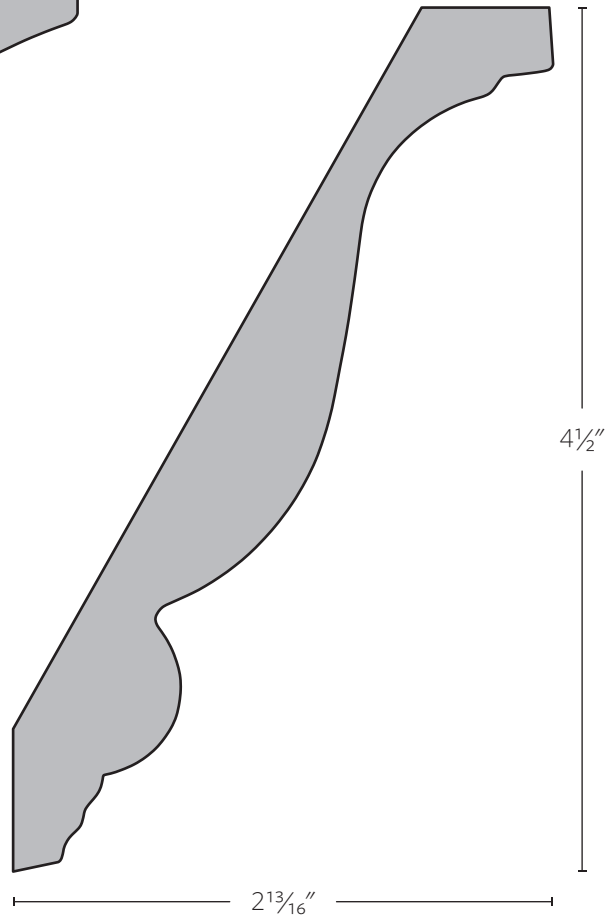

SWD 5117 | $\frac{3}{4}'' \times 5\frac{1}{4}''$ | 30/60

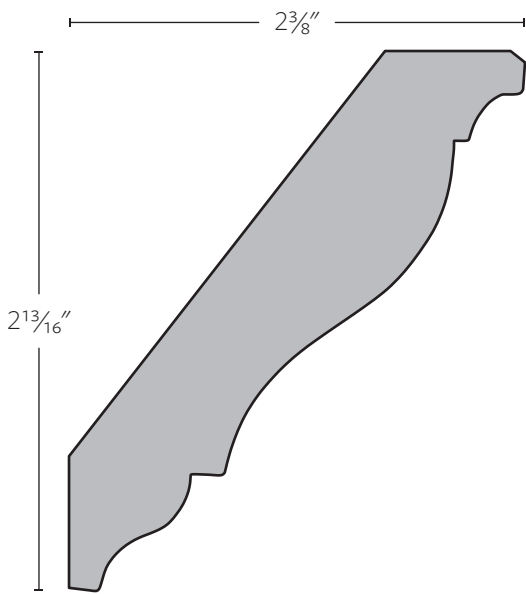

SWD 5118 | $1\frac{3}{16}'' \times 3\frac{5}{8}''$ | 30/60

SECTION 6

Tongue & Groove Profiles

Plinths

Handrail Profiles

Tongue & Groove Profiles



SWD 600 | $\frac{3}{4}$ " x $5\frac{1}{2}$ " | $5\frac{1}{4}$ " Lay



SWD 601 | $\frac{3}{4}$ " x $5\frac{1}{2}$ " | $5\frac{1}{4}$ " Lay

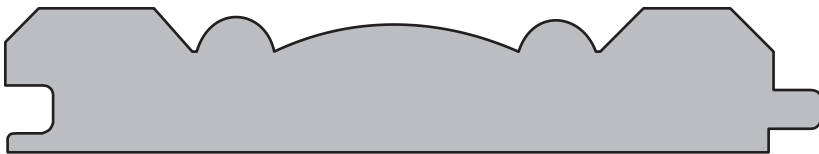

SWD 602 | $\frac{3}{4}$ " x $4\frac{1}{4}$ " | 4" Lay



SWD 603 | $\frac{3}{4}$ " x $3\frac{3}{4}$ " | $3\frac{1}{2}$ " Lay

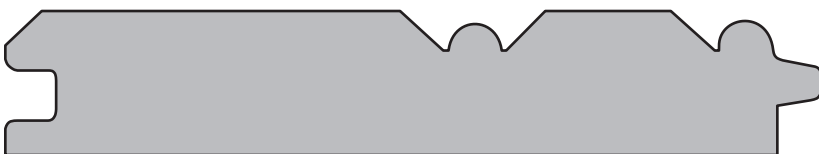

SWD 604 | $\frac{3}{4}$ " x $4\frac{1}{4}$ " | 4" Lay



SWD 605 | $\frac{3}{4}$ " x $4\frac{1}{2}$ " | $4\frac{1}{4}$ " Lay



SWD 606 | $\frac{3}{4}$ " x Customer Specs | Flooring



SWD 607 | $\frac{3}{4}$ " x $3\frac{9}{16}$ " | $2\frac{7}{8}$ " Lay



SWD 608 | $\frac{3}{4}$ " x $2\frac{9}{16}$ " | $2\frac{1}{4}$ " Lay



SWD 609 | $\frac{3}{4}$ " x $4\frac{1}{2}$ " | $4\frac{1}{4}$ " Lay



SWD 610 | $\frac{3}{4}$ " x 3" | $2\frac{3}{4}$ " Lay



SWD 611 | $\frac{3}{4}'' \times 3\frac{3}{4}''$ | $3\frac{1}{2}''$ Lay



SWD 612 | $\frac{3}{4}'' \times 2\frac{3}{4}''$ | $2\frac{1}{2}''$ Lay

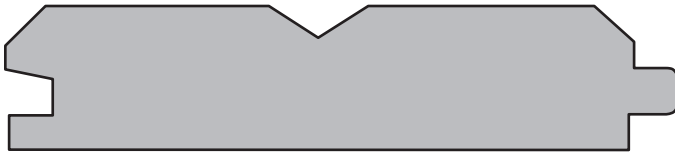

SWD 613 | $\frac{3}{4}'' \times 3\frac{1}{2}''$ | $3\frac{1}{4}''$ Lay



SWD 614 | $\frac{3}{4}'' \times 3\frac{1}{4}''$ | $3''$ Lay

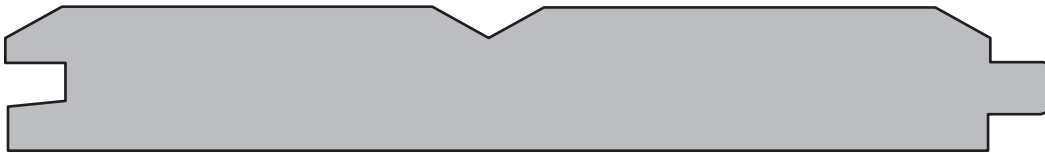

SWD 615 | $\frac{3}{4}'' \times 5\frac{7}{16}''$ | $5\frac{1}{8}''$ Lay

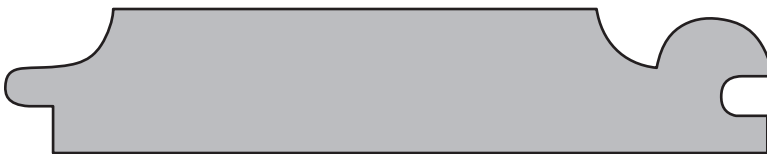

SWD 616 | $\frac{3}{4}'' \times 4''$ | $3\frac{3}{4}''$ Lay



SWD 617 | $\frac{1}{2}''$ x $3\frac{1}{4}''$ | 3" Lay

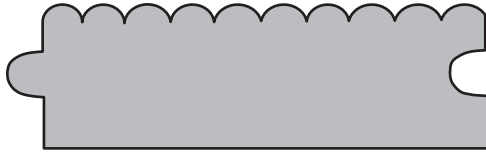

SWD 619 | $\frac{3}{4}''$ x $2\frac{1}{2}''$ | $2\frac{1}{4}''$ Lay

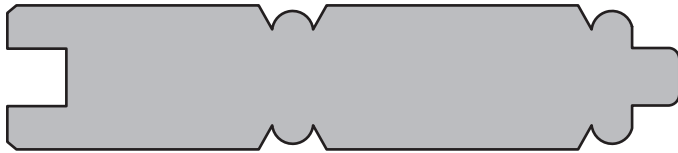

SWD 620 | $\frac{3}{4}''$ x $3\frac{1}{2}''$ | $3\frac{1}{4}''$ Lay



SWD 622 | $\frac{3}{4}''$ x $1\frac{13}{16}''$
 $1\frac{9}{16}''$ Lay



SWD 623 | $\frac{3}{4}''$ x $4\frac{1}{4}''$ | 4" Lay

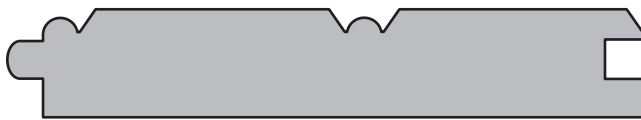

SWD 625 | $\frac{9}{16}''$ x $3\frac{5}{16}''$ | $3\frac{1}{8}''$ Lay

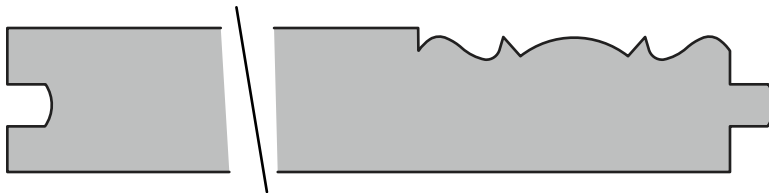

SWD 626 | $\frac{3}{4}''$ x Customer Specs

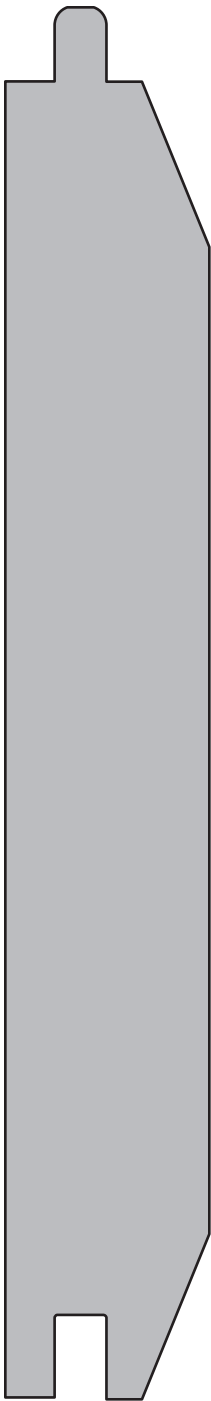

SWD 618
1 1/16" x 7 1/4"
6 13/16" Lay

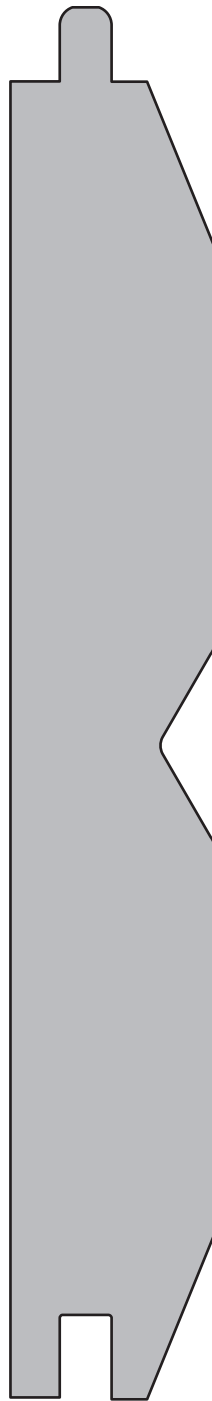

SWD 618-S
1 1/16" x 7 1/4"
6 13/16" Lay

SWD 624
3/4" x 9 1/4"



SWD 627 | 3/4" x Customer Specs

Plinths

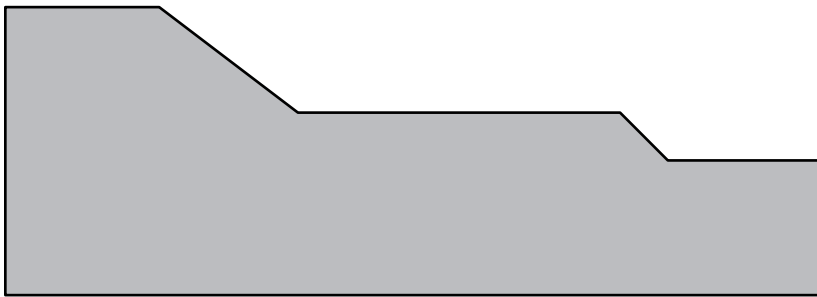

SWD 655 | $1\frac{1}{2}'' \times 4\frac{1}{4}''$

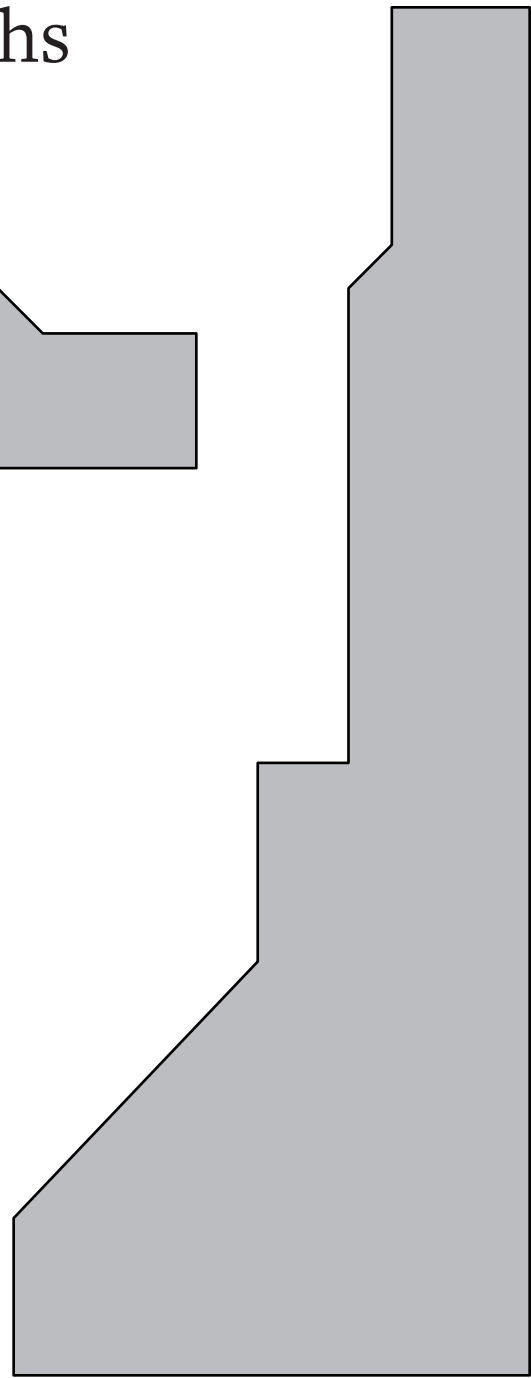

SWD 654 | $2\frac{11}{16}'' \times 7\frac{1}{8}''$

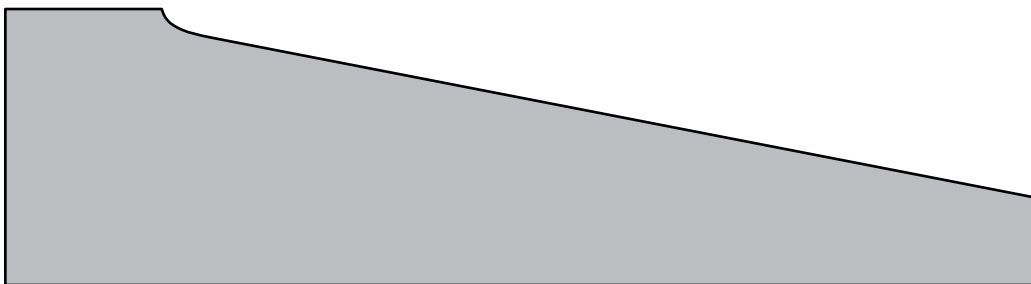

SWD 653 | $1\frac{7}{16}'' \times 5\frac{3}{8}''$

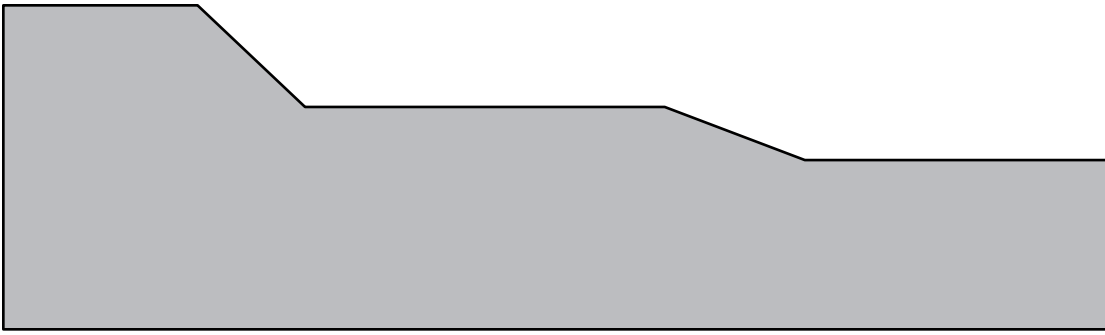

SWD 656 | $1\frac{1}{16}'' \times 5\frac{3}{4}''$

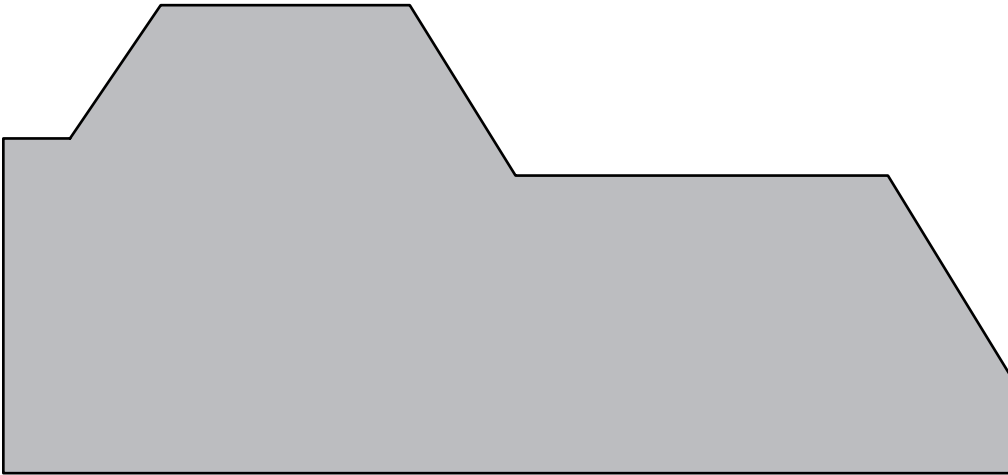

SWD 657 | $2\frac{7}{16}'' \times 5\frac{1}{4}''$

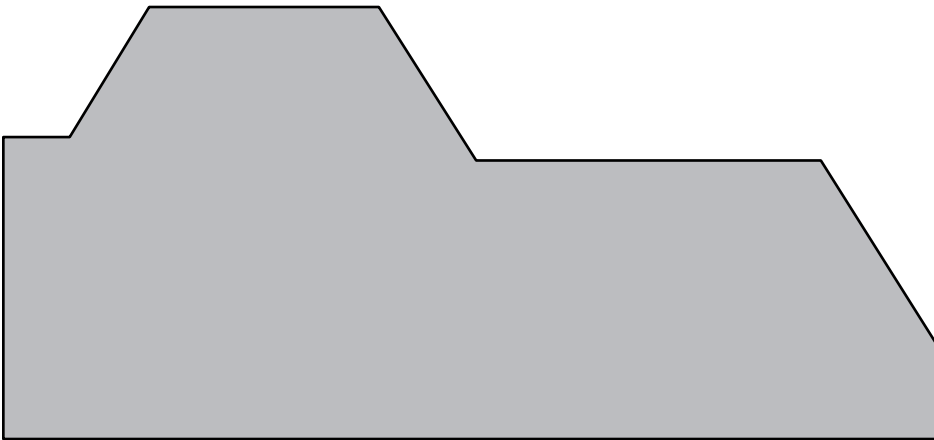

SWD 658 | $2\frac{1}{4}'' \times 4\frac{7}{8}''$

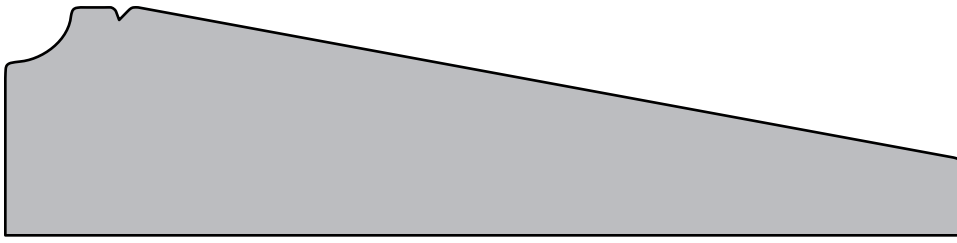

SWD 659 | $1\frac{3}{16}'' \times 5''$

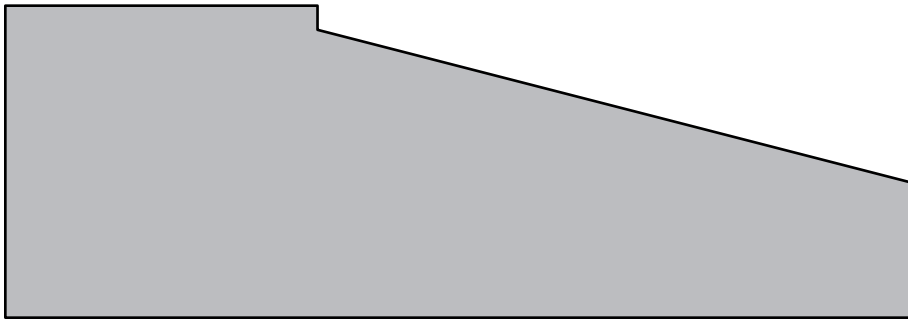

SWD 660 | $1\frac{5}{8}'' \times 4\frac{3}{4}''$

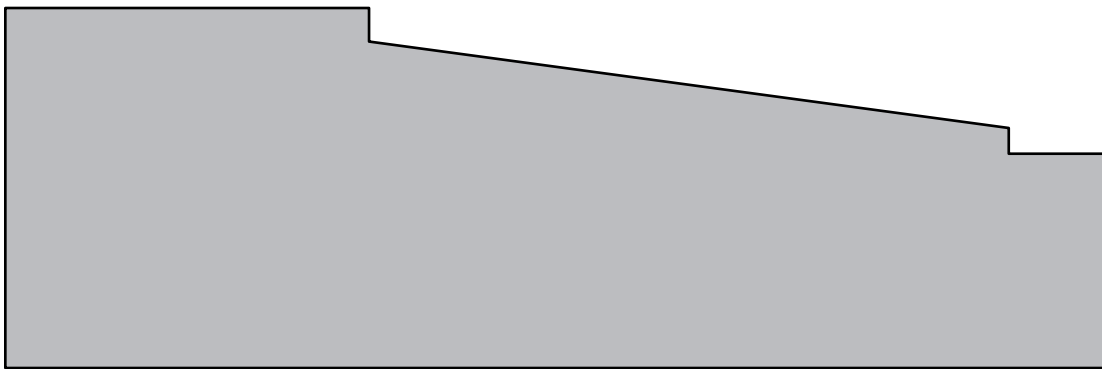

SWD 661 | $1\frac{7}{8}'' \times 5\frac{3}{4}''$



SWD 662 | 1 5/8" x 6"

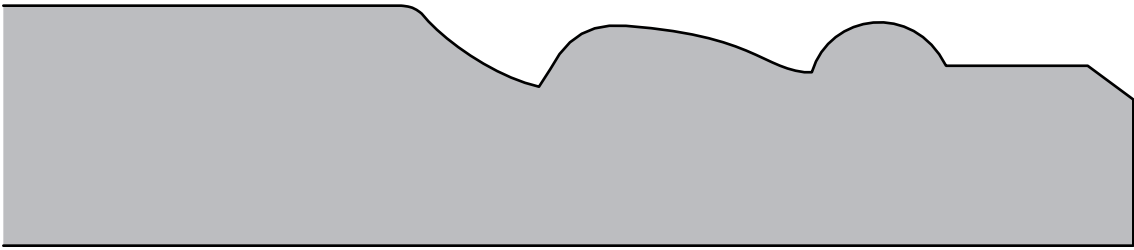

SWD 663 | 1 1/4" x Customer Specs

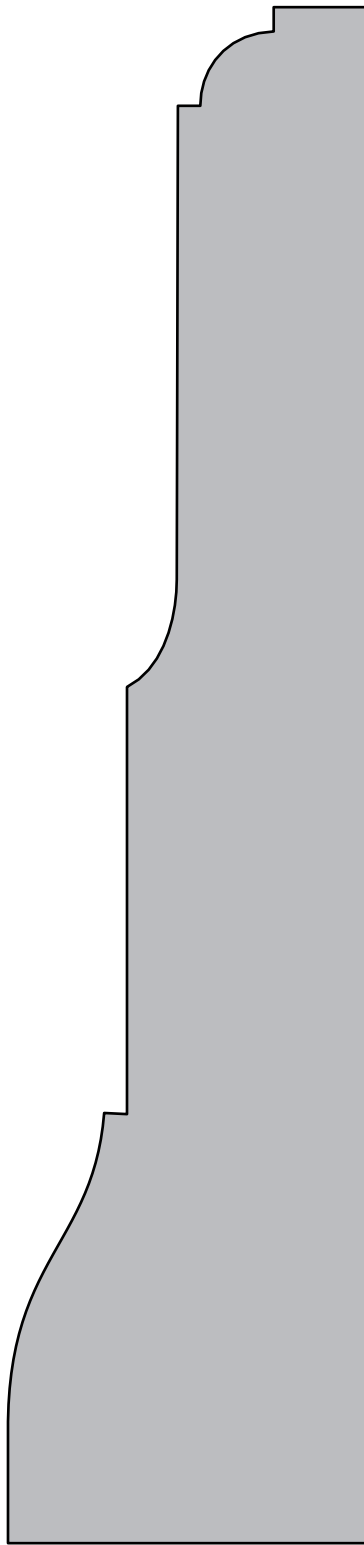

SWD 664 | 1 $\frac{7}{8}$ " x 8"

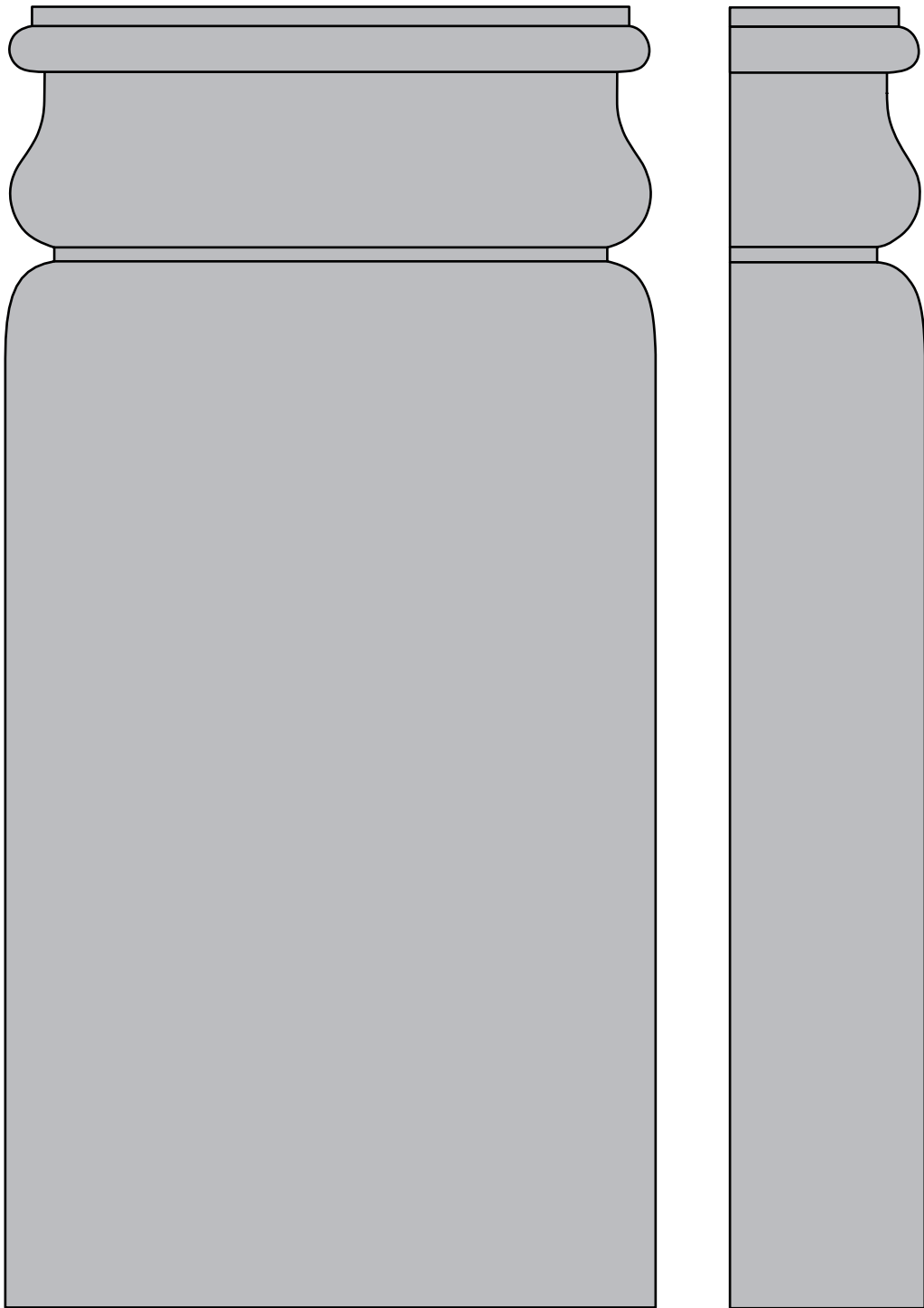

SWD 665 | $1\frac{1}{8}'' \times 3\frac{3}{4}'' \times 7\frac{1}{2}''$
Also Available | $1\frac{1}{8}'' \times 6\frac{1}{8}'' \times 7\frac{1}{2}''$

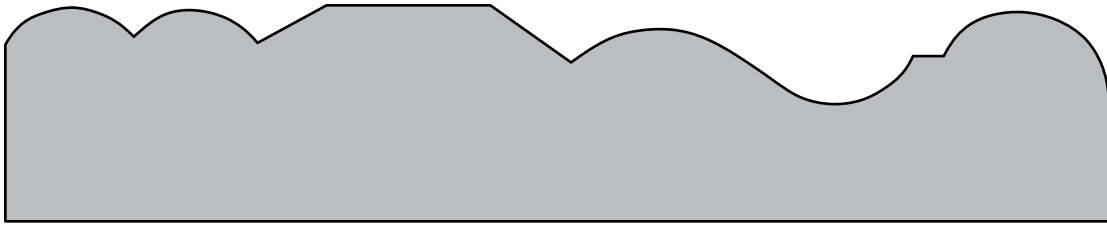

SWD 667 | $1\frac{1}{8}'' \times 5\frac{3}{4}''$

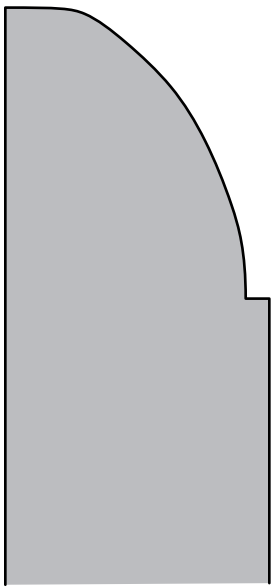

SWD 668 | $1\frac{3}{8}'' \times 1\frac{3}{8}'' \times$ Customer Specs | Corner Block

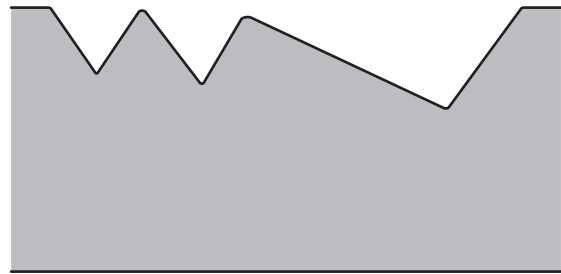

SWD 669 | $1\frac{3}{8}'' \times$ Customer Specs

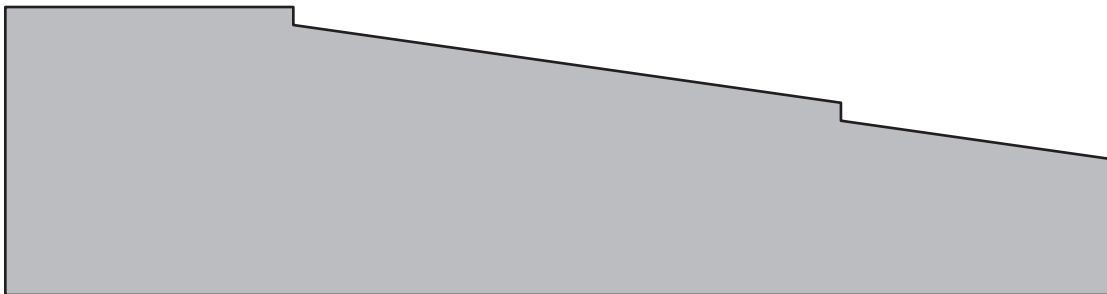

SWD 670 | $1\frac{1}{2}'' \times 5\frac{3}{4}''$

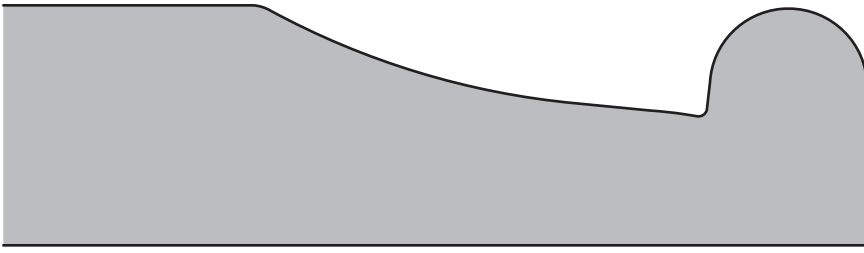

SWD 671 | 1¼" x Customer Specs

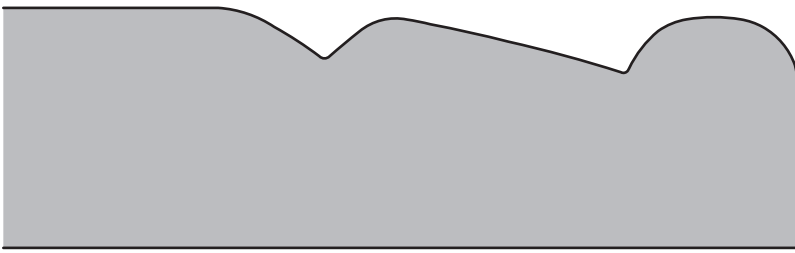

SWD 672 | 1¼" x Customer Specs

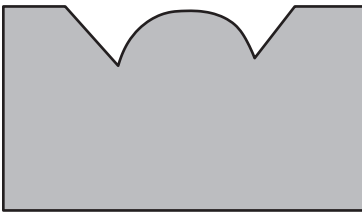

SWD 673 | 1¼" x 1⅞"

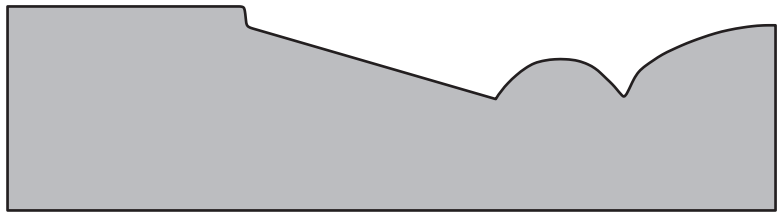

SWD 674 | 1¼" x 4"

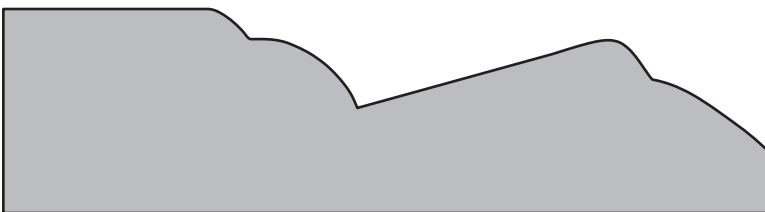

SWD 675 | 1¼" x 4"

Handrail Profiles

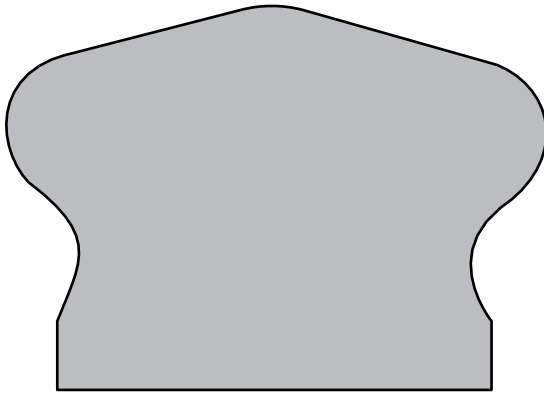

SWD 6000 | 2" x 2¹³/₁₆"



SWD 6000-SR | 3/4" x 3" | Shoe Rail

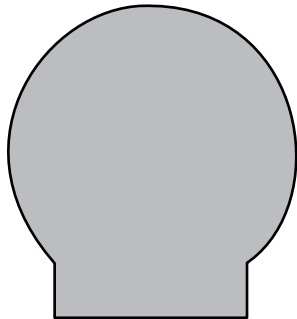

SWD 6003 | 1⁵/₈" x 1¹/₂"

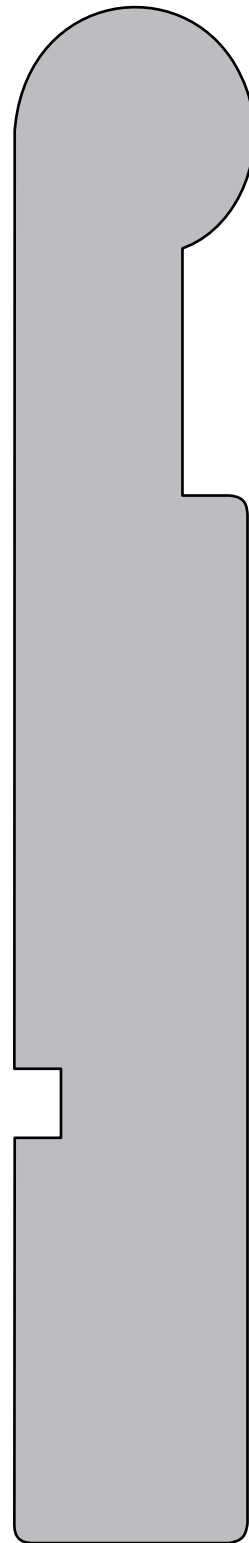

SWD 6002 | 8" x 1¹/₄"

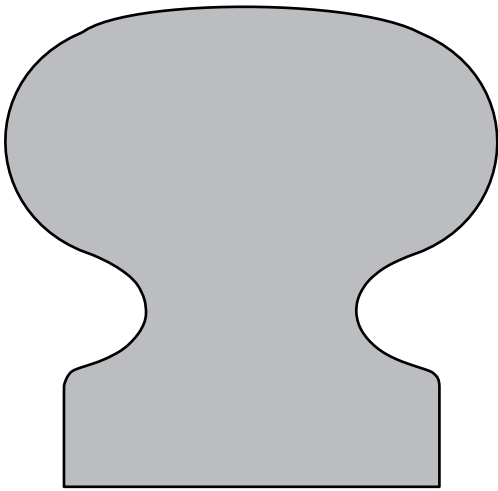

SWD 6004 | $2\frac{1}{2}'' \times 2\frac{9}{16}''$

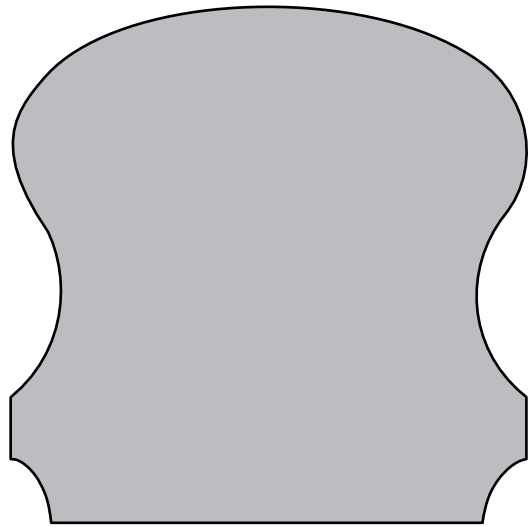

SWD 6005 | $2\frac{11}{16}'' \times 2\frac{11}{16}''$

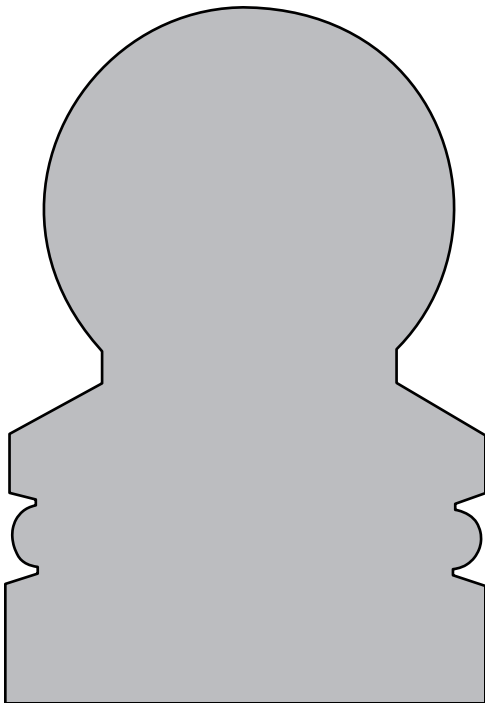

SWD 6006 | $3\frac{5}{8}'' \times 2\frac{1}{2}''$

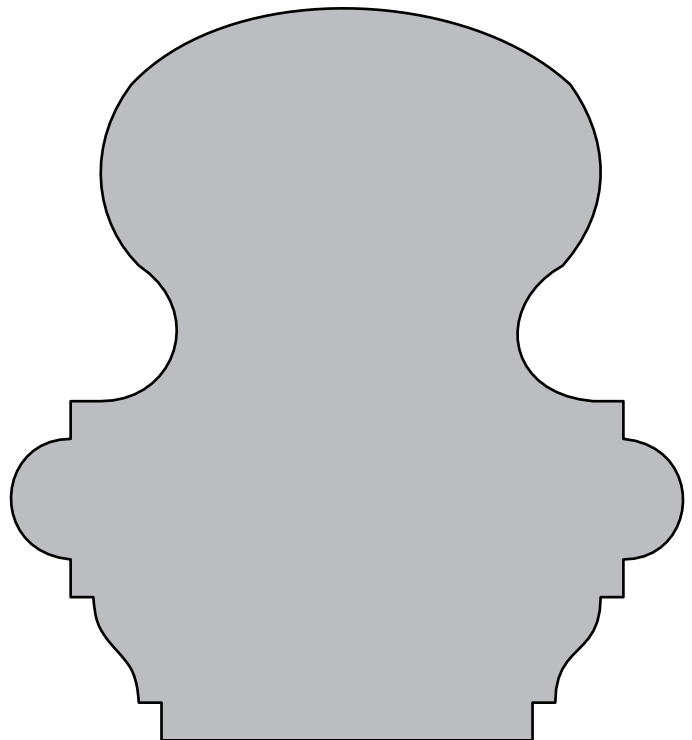

SWD 6007 | $3\frac{13}{16}'' \times 3\frac{1}{2}''$

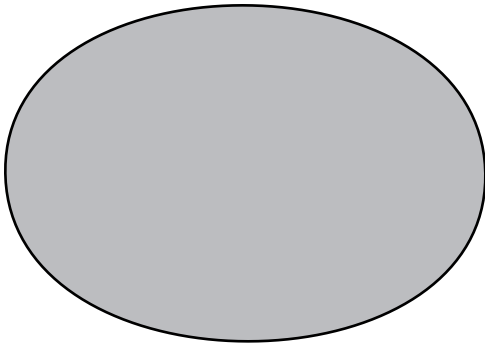

SWD 6008 | $1\frac{3}{4}'' \times 2\frac{1}{2}''$

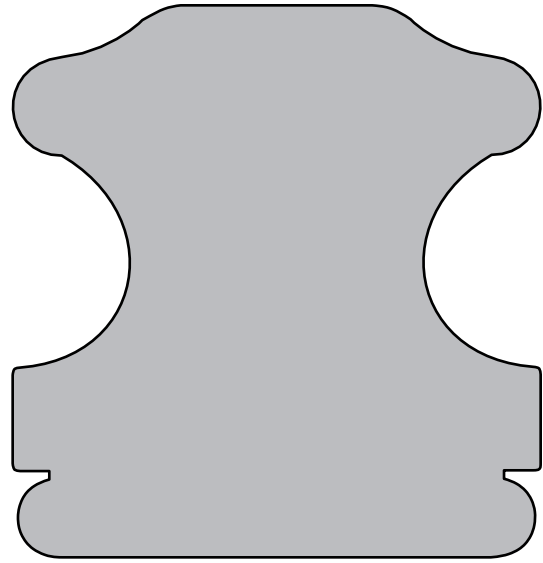

SWD 6009 | $2\frac{7}{8}'' \times 2\frac{3}{4}''$

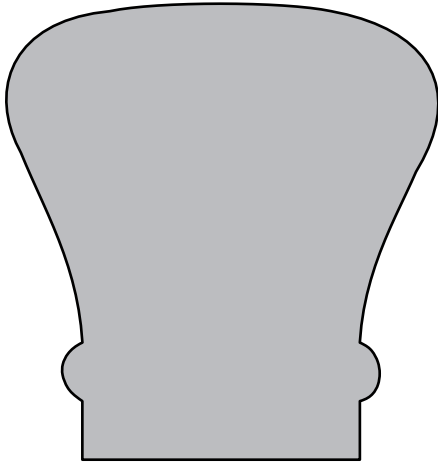

SWD 6010 | $2\frac{3}{8}'' \times 2\frac{1}{4}''$

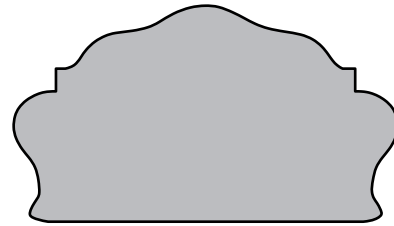

SWD 6011 | $1\frac{1}{8}'' \times 2''$

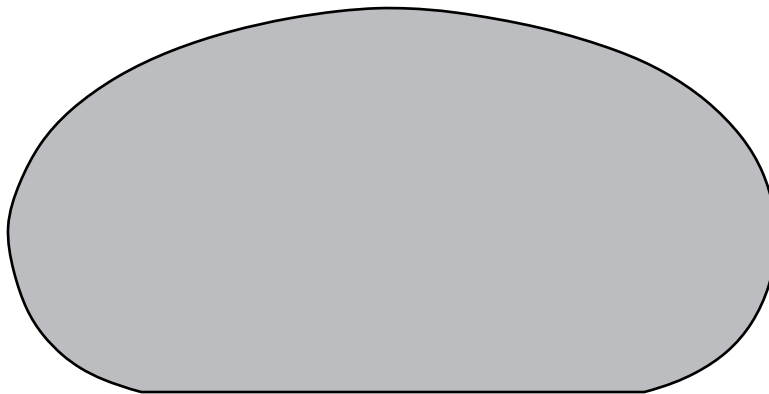

SWD 6012 | $2'' \times 4''$

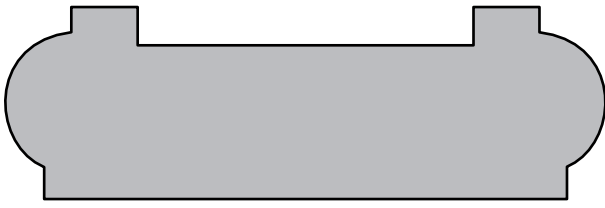

SWD 6013 | 1" x 3 $\frac{1}{8}$ "

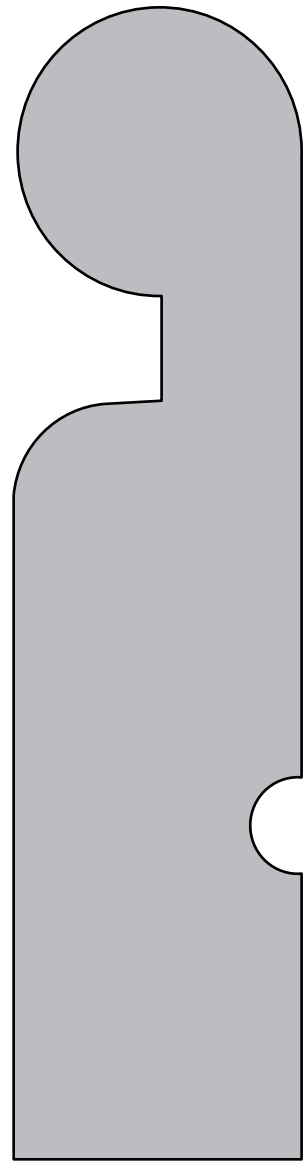

SWD 6014 | 6" x 1 $\frac{1}{2}$ "

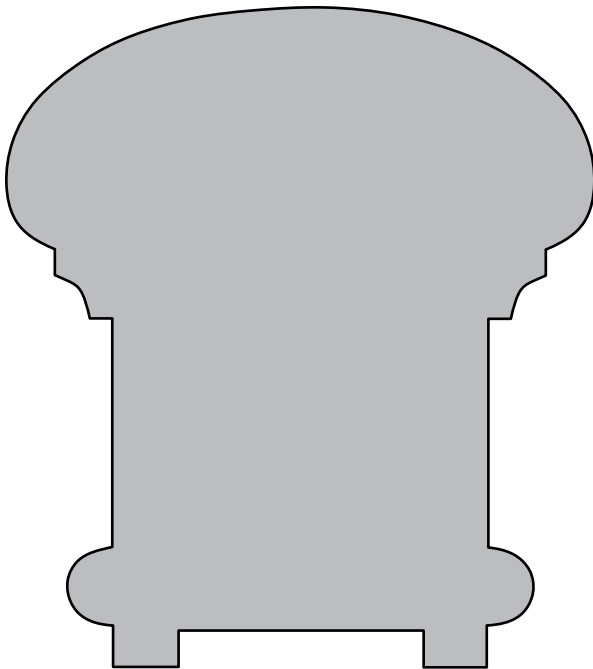

SWD 6015 | 3 $\frac{7}{16}$ " x 3 $\frac{1}{16}$ "

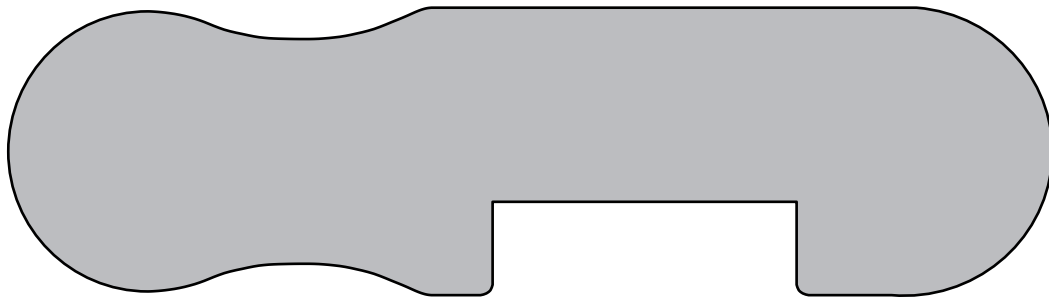

SWD 6016 | 1 $\frac{1}{2}$ " x 5 $\frac{7}{16}$ "

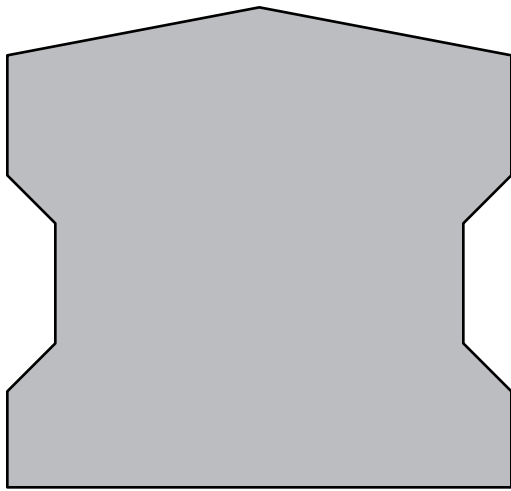

SWD 6017 | $2\frac{1}{2}'' \times 2\frac{5}{8}''$

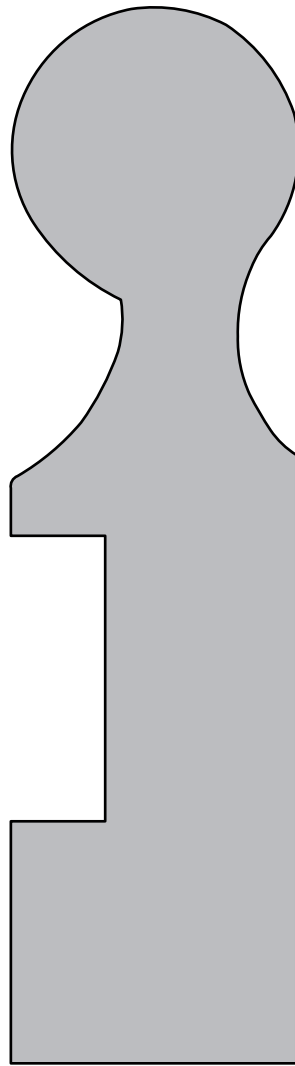

SWD 6020 | $1\frac{1}{2}'' \times 5\frac{1}{2}''$

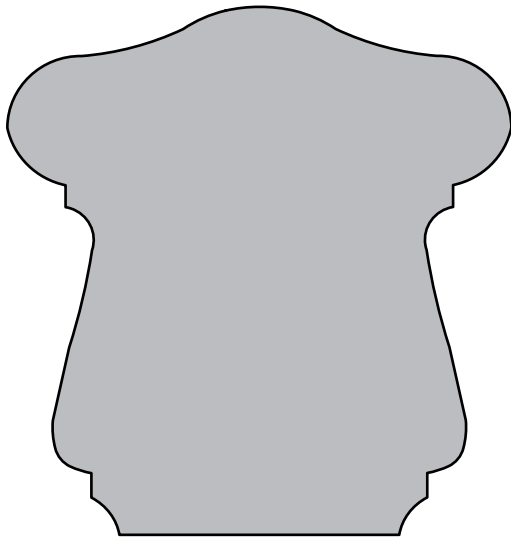

SWD 6019 | $2\frac{5}{8}'' \times 2\frac{3}{4}''$

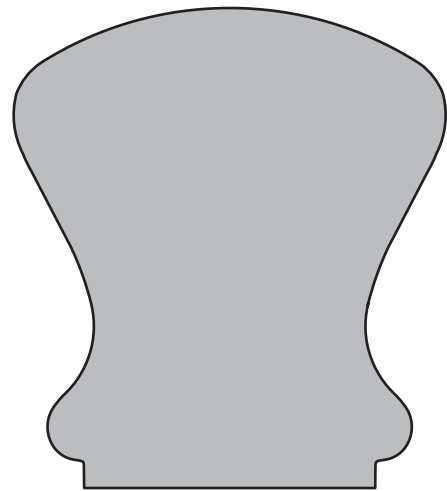

SWD 6021 | $2\frac{1}{4}'' \times 2\frac{1}{2}''$

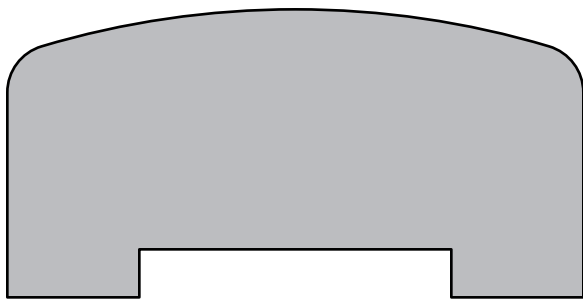

SWD 6018 | $1\frac{1}{2}'' \times 3''$



SWD 6022 | $1\frac{3}{8}'' \times 2\frac{1}{16}''$

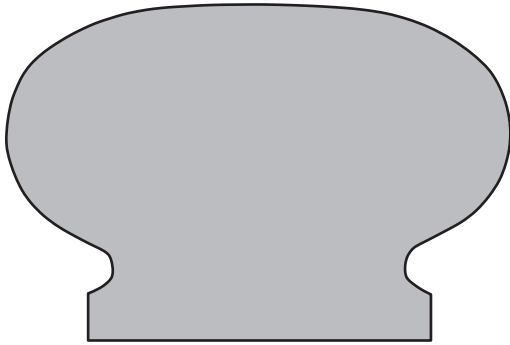

SWD 6023 | $1\frac{3}{4}'' \times 2\frac{5}{8}''$

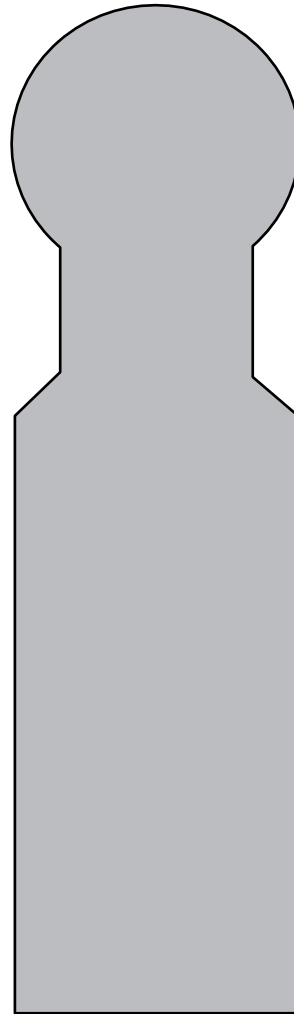

SWD 6051 | $5\frac{1}{4}'' \times 1\frac{1}{2}''$

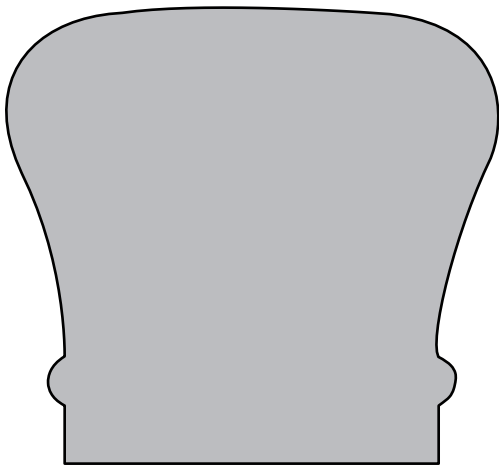

SWD 6210 | $2\frac{3}{8}'' \times 2\frac{9}{16}''$

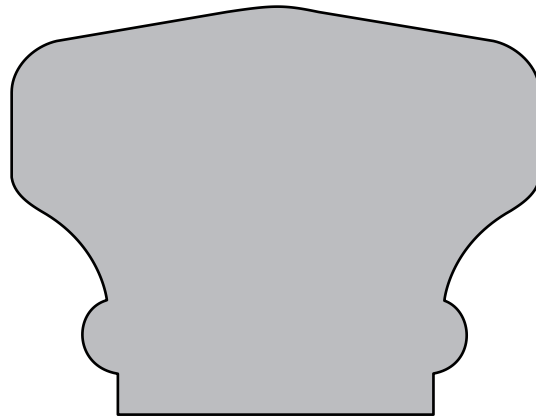

SWD 6701 | $2\frac{1}{8}'' \times 2\frac{3}{4}''$

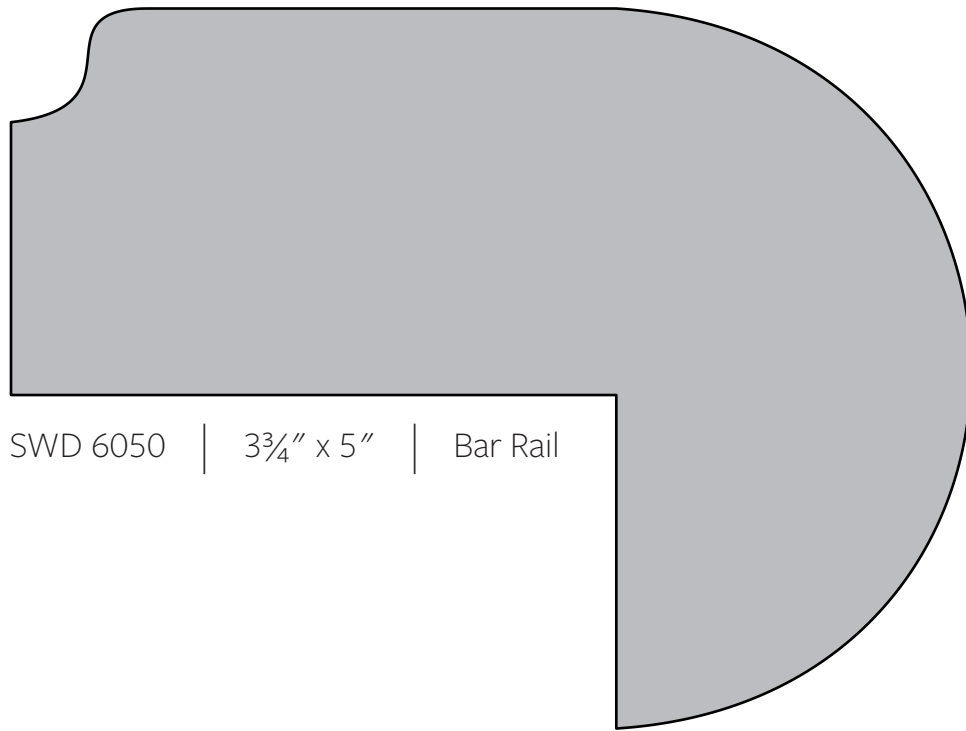

SWD 6050 | $3\frac{3}{4}'' \times 5''$ | Bar Rail

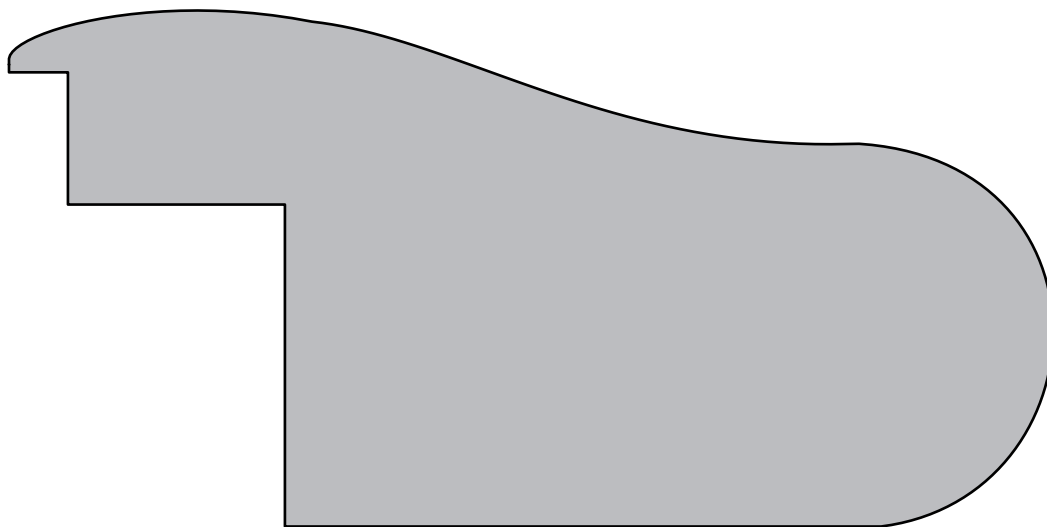

SWD 096/913 | $2\frac{1}{16}'' \times 5\frac{7}{16}''$ | Bar Rail

SECTION 7

Door Stop Profiles



SWD 700 | $\frac{7}{16}'' \times 1\frac{3}{8}''$

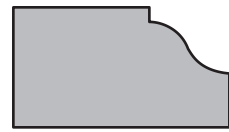

SWD 700-S | $\frac{5}{8}'' \times 1\frac{1}{8}''$
Shelf Edge



SWD 701 | $\frac{7}{16}'' \times 1\frac{3}{8}''$



SWD 702 | $\frac{7}{16}'' \times 1\frac{3}{8}''$



SWD 703 | $\frac{7}{16}'' \times 1\frac{3}{8}''$



SWD 704 | $\frac{7}{16}'' \times 1\frac{3}{8}''$



SWD 705 | $\frac{7}{16}'' \times 1\frac{3}{8}''$



SWD 706 | $\frac{7}{16}'' \times 1\frac{3}{8}''$



SWD 707 | $\frac{7}{16}'' \times 1\frac{3}{8}''$



SWD 708 | $\frac{7}{16}'' \times 1\frac{3}{8}''$



SWD 709 | $\frac{7}{16}'' \times 1\frac{3}{4}''$



SWD 710 | $\frac{7}{16}'' \times \frac{7}{8}''$



SWD 711 | $1\frac{7}{32}'' \times 1\frac{1}{4}''$



SWD 712 | $\frac{1}{2}'' \times 1''$

SECTION 8

Miscellaneous Profiles

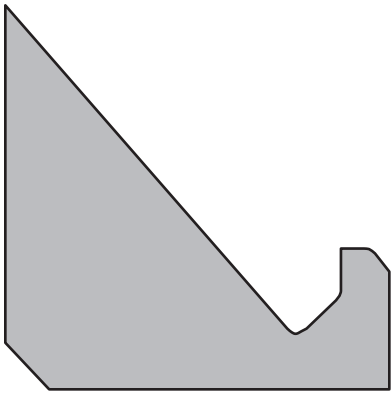

SWD 807 | 2" x 2" | Easel Mould

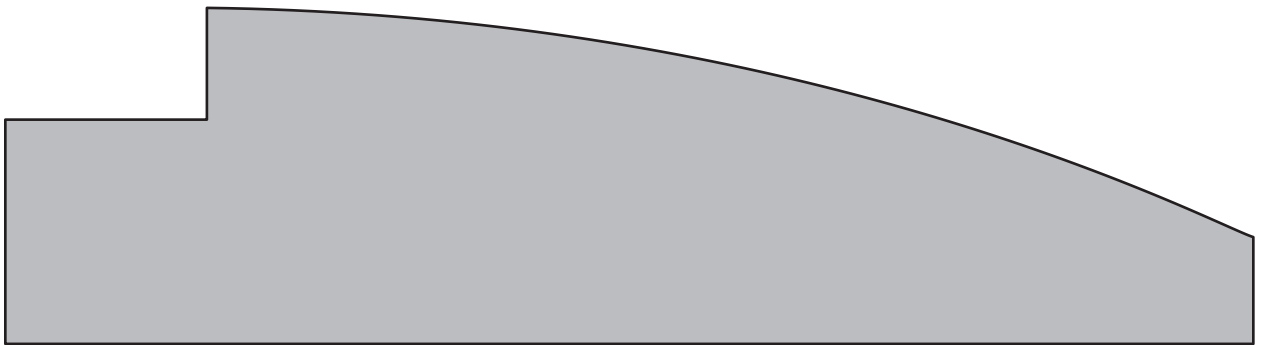

SWD 810 | 1 $\frac{3}{4}$ " x 6 $\frac{1}{2}$ "

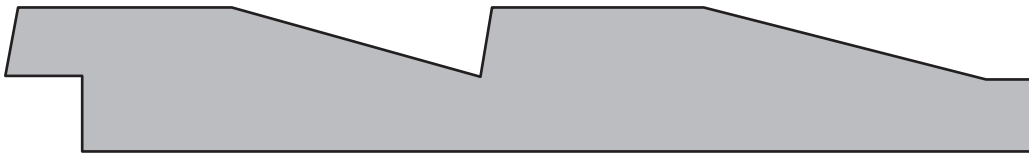

SWD 813 | $\frac{3}{4}$ " x 5 $\frac{3}{8}$ " | Siding

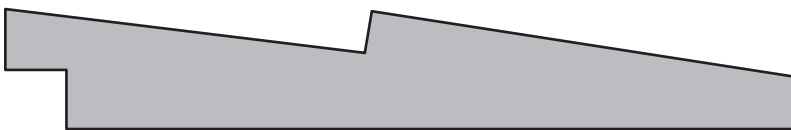

SWD 814 | $\frac{5}{8}$ " x 4 $\frac{1}{8}$ " | Siding

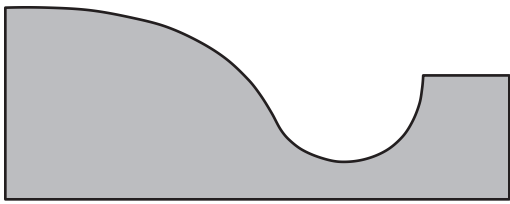

SWD 815 | 1" x 2⁵/₈" | Dentil



SWD 816 | 3/4" x 5 1/2"



SWD 817 | 3/4" x Customer Specs

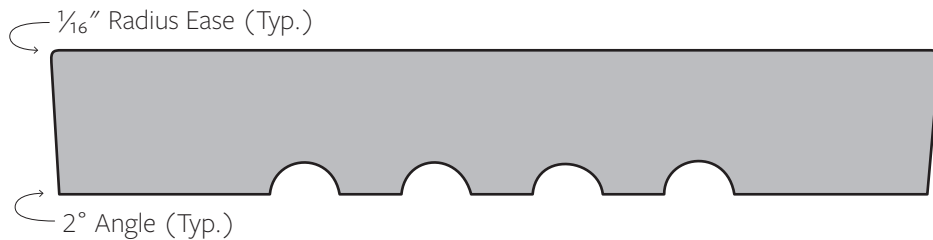

SWD 823 | 3/4" x 4⁵/₈" | Standard Jamb

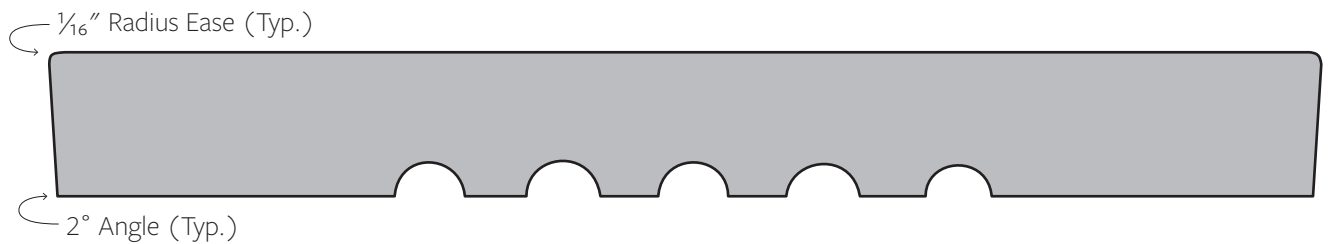

SWD 824 | 3/4" x 6⁵/₈" | Standard Jamb

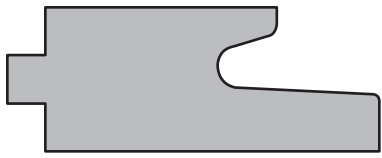

SWD 826 | $\frac{3}{4}'' \times 1\frac{15}{16}''$ | Cabinet Pull

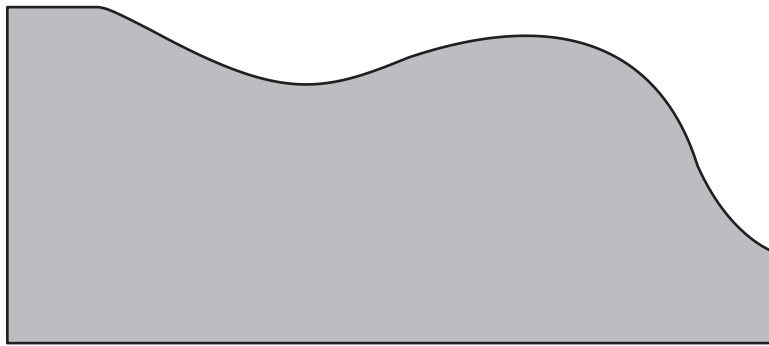

SWD 827 | $1\frac{3}{4}'' \times 4''$

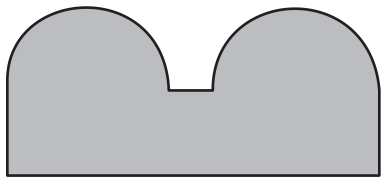

SWD 840 | $\frac{7}{8}'' \times 1\frac{15}{16}''$

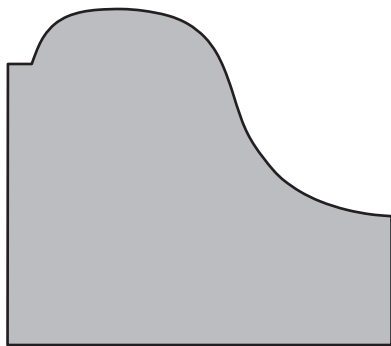

SWD 843 | $2'' \times 1\frac{3}{4}''$

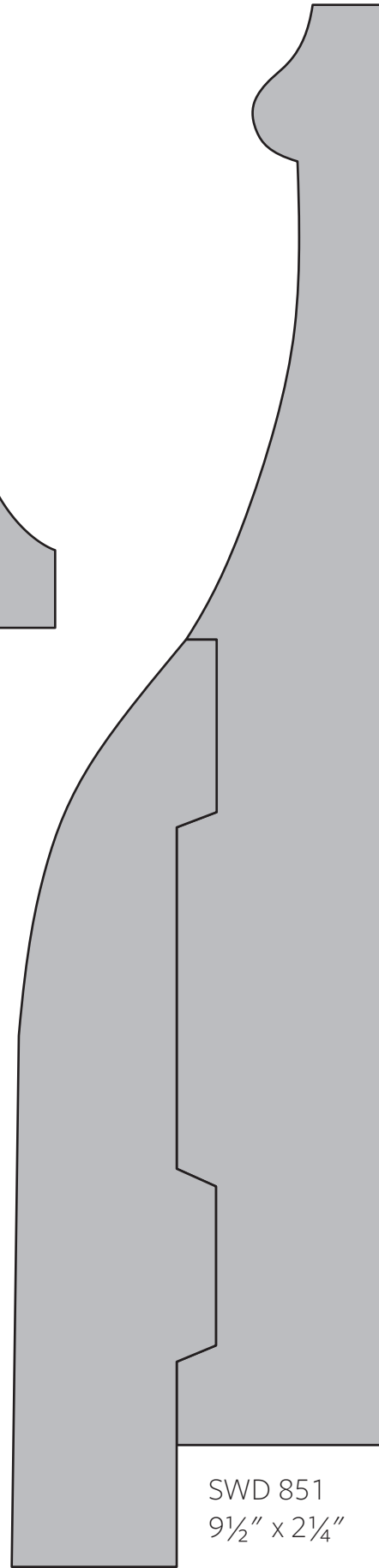

SWD 851
 $9\frac{1}{2}'' \times 2\frac{1}{4}''$

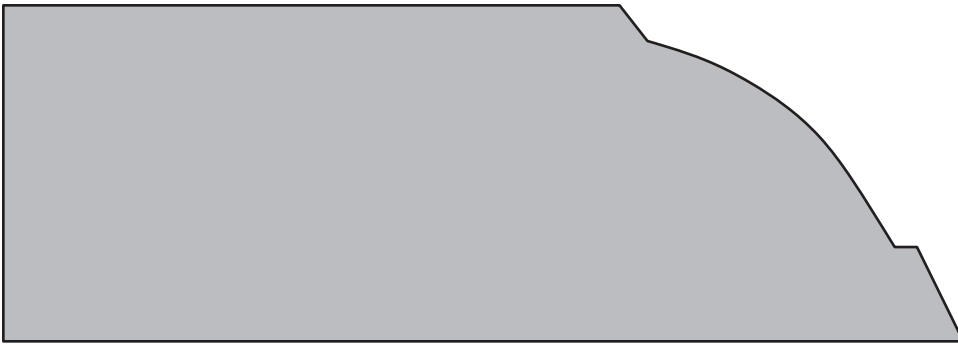

SWD 853 | $1\frac{3}{4}'' \times 5''$

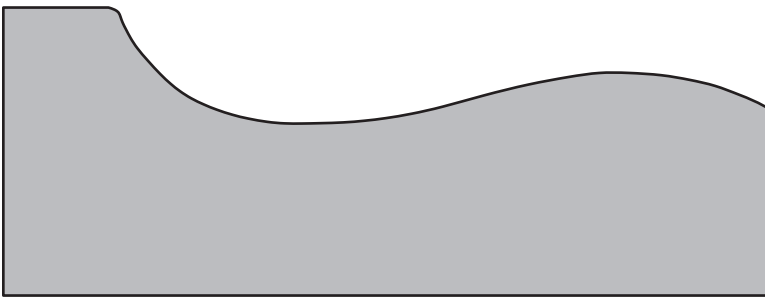

SWD 858 | $1\frac{1}{2}'' \times 4''$

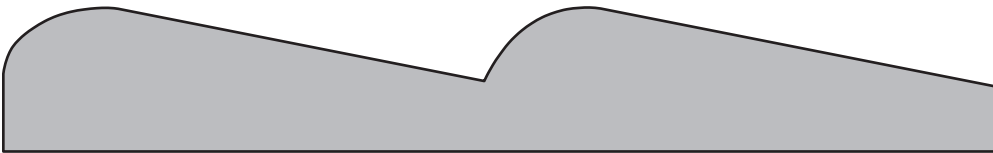

SWD 859 | $\frac{3}{4}'' \times 5\frac{3}{16}''$

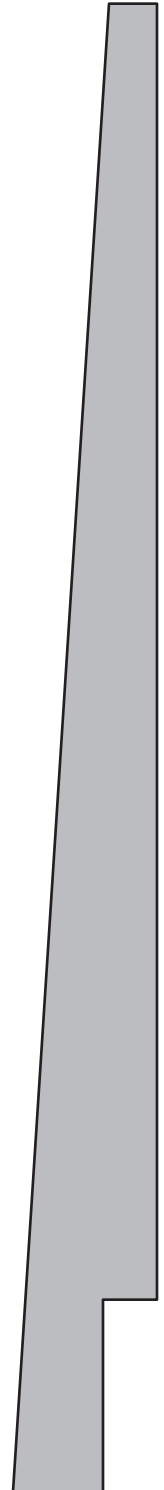

SWD 854
 $\frac{3}{4}'' \times 7\frac{3}{4}''$
Lap Siding

SECTION 9

Bullnose Profiles



SWD 901 | $\frac{3}{4}$ " x Customer Specs

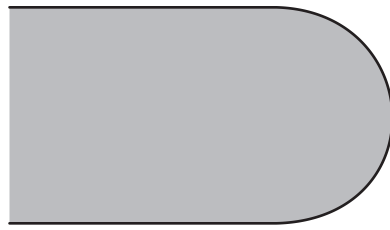

SWD 902 | $1\frac{1}{8}$ " x Customer Specs

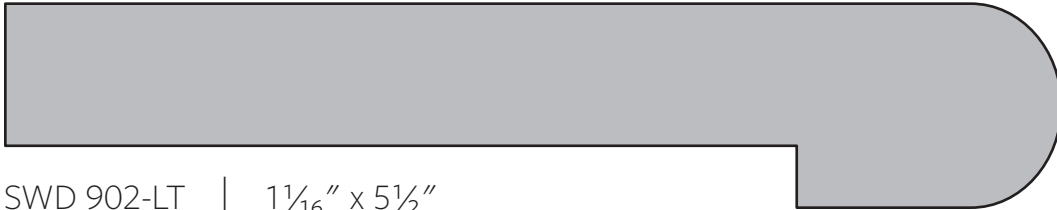

SWD 902-LT | $1\frac{1}{16}$ " x $5\frac{1}{2}$ "

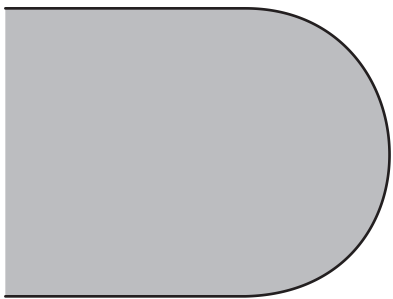

SWD 903 | $1\frac{1}{2}$ " x Customer Specs



SWD 904 | 1" x Customer Specs

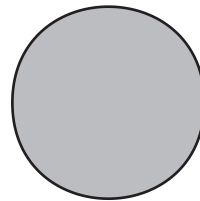

SWD 904-R | 1" Round



SWD 907 | $\frac{7}{8}$ " x Customer Specs

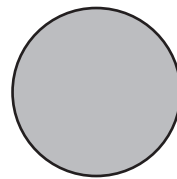

SWD 907-R | $\frac{7}{8}$ " Round

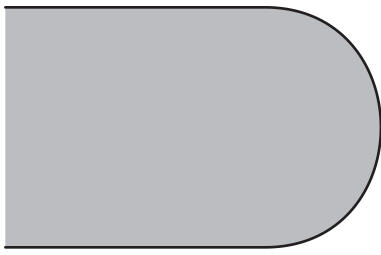

SWD 908 | $1\frac{1}{4}$ " x Customer Specs



SWD 909 | $\frac{9}{16}$ " x $3\frac{7}{8}$ "

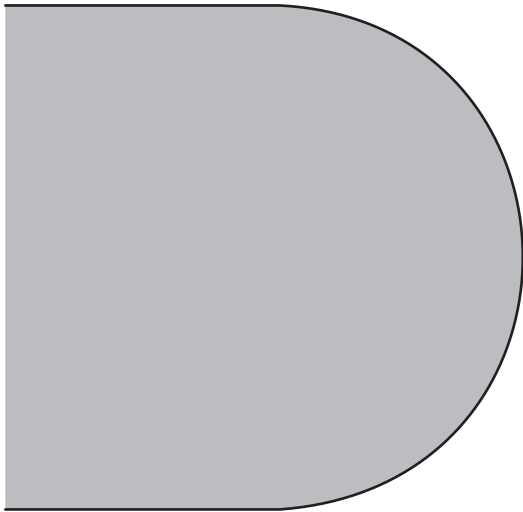

SWD 910 | $2\frac{5}{8}$ " x Customer Specs

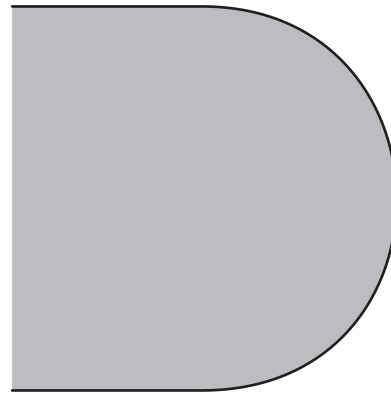

SWD 913 | 2" x Customer Specs



SWD 914 | $\frac{3}{4}$ " x $4\frac{3}{4}$ "

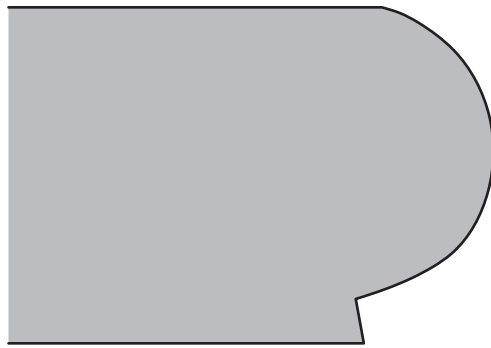

SWD 915 | $1\frac{3}{4}$ " x Customer Specs

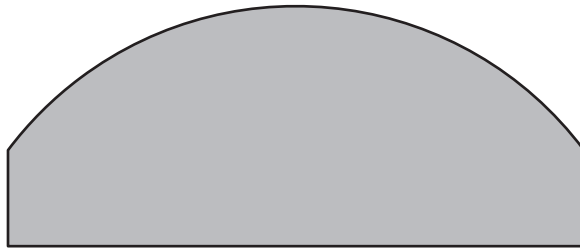

SWD 916 | $1\frac{1}{4}$ " x 3"

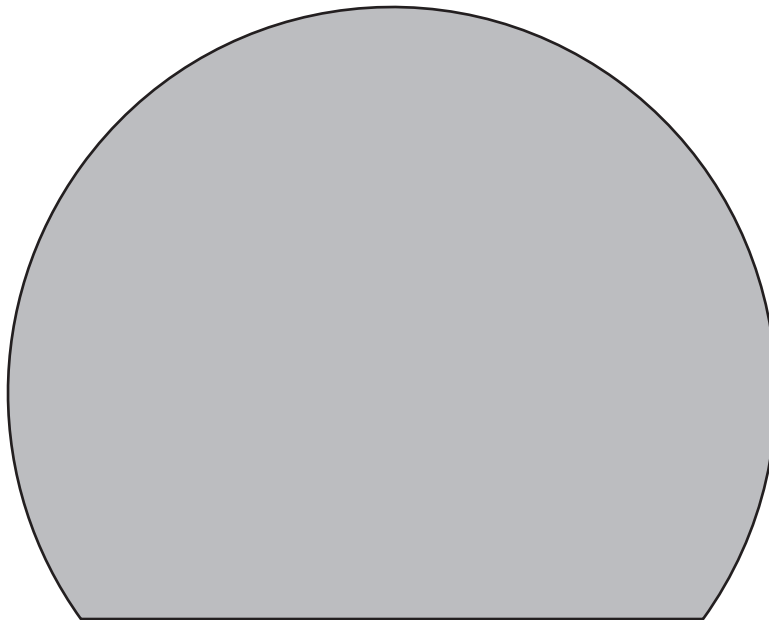

SWD 919 | $3\frac{3}{16}$ " x 4"



SOMMERS

WOOD-N-DOOR INC