

# SECTION 4

## Entry Doors

# Entry Door Styles

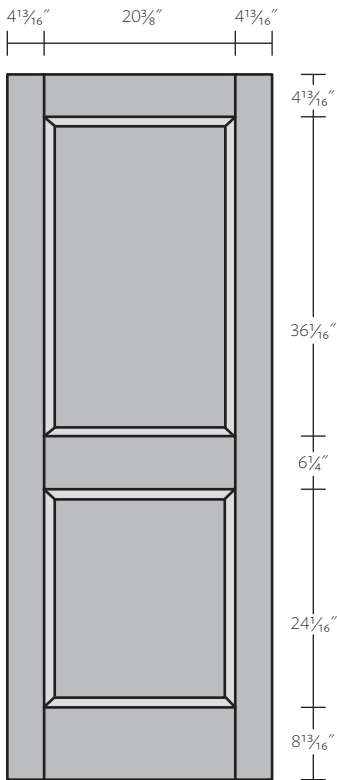

Two Panel Door

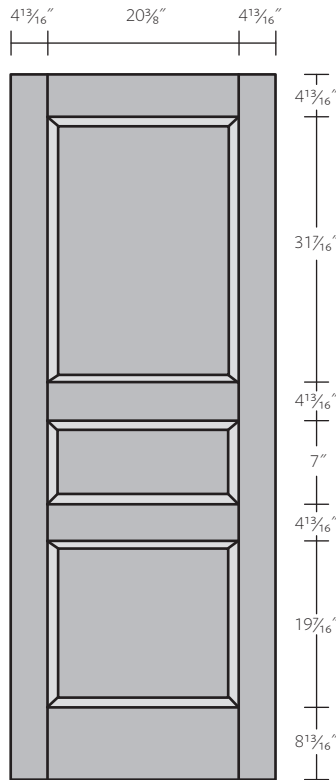

Three Panel Door

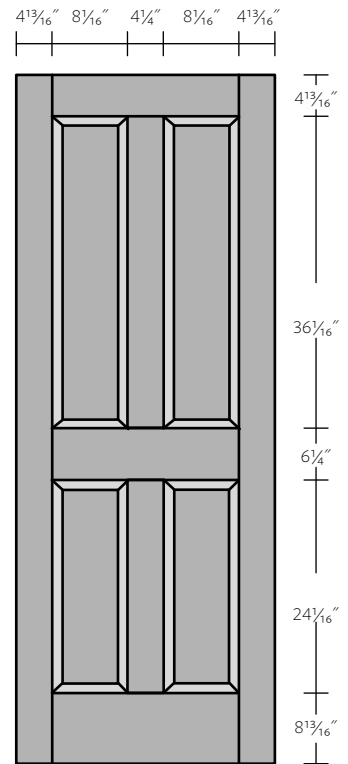

Four Panel Door

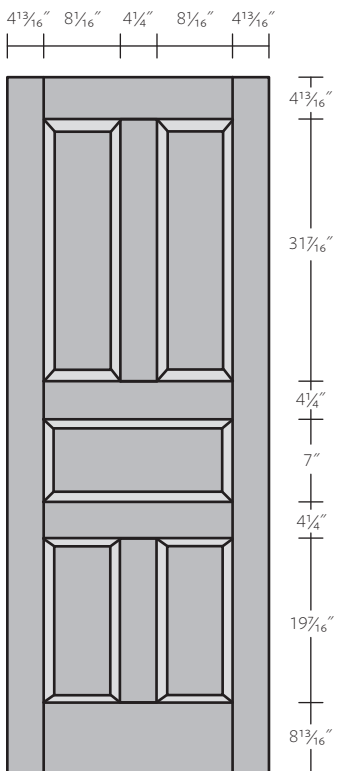

Five Panel Door

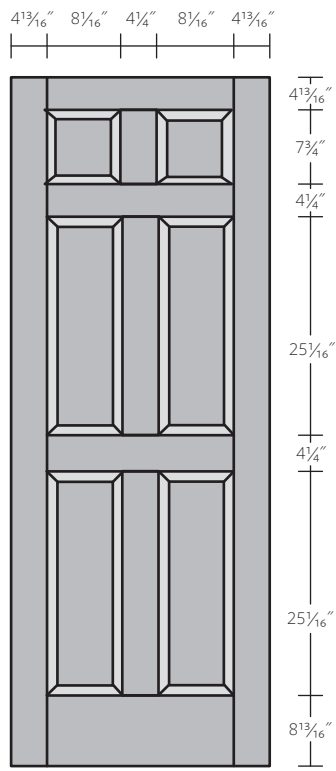

Six Panel Door

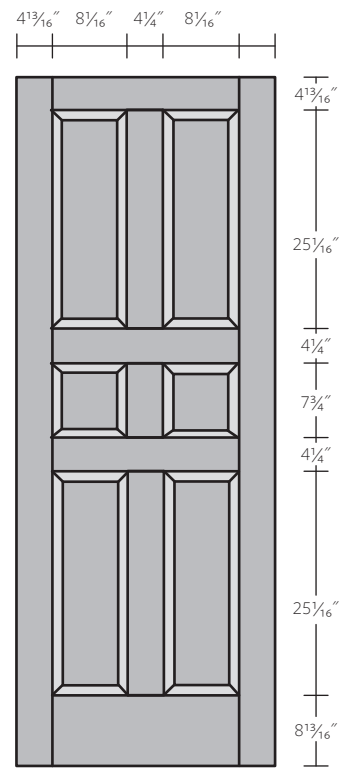

Six Panel Door  
(Alternate)

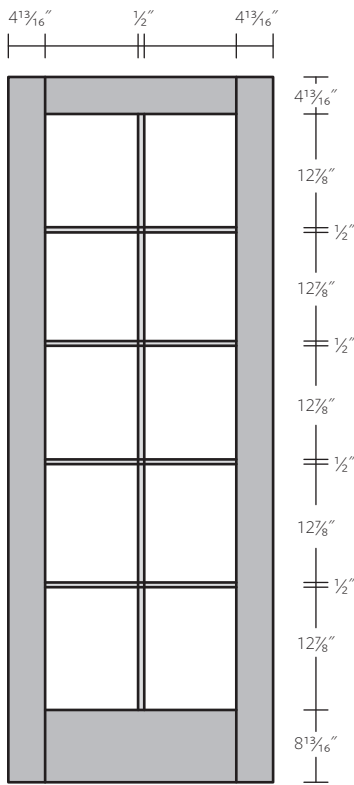

Ten Light Glass Door

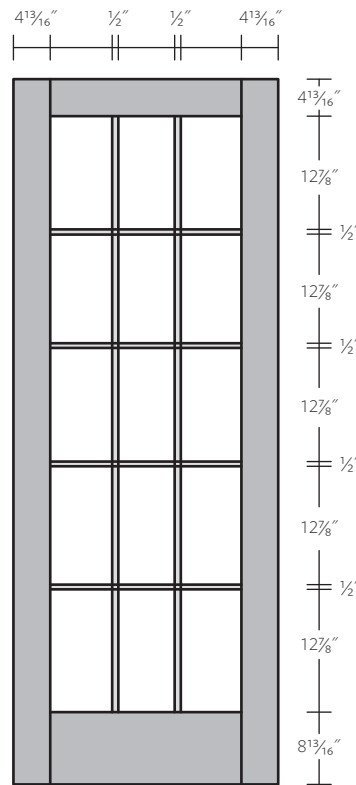

Fifteen Light Glass Door

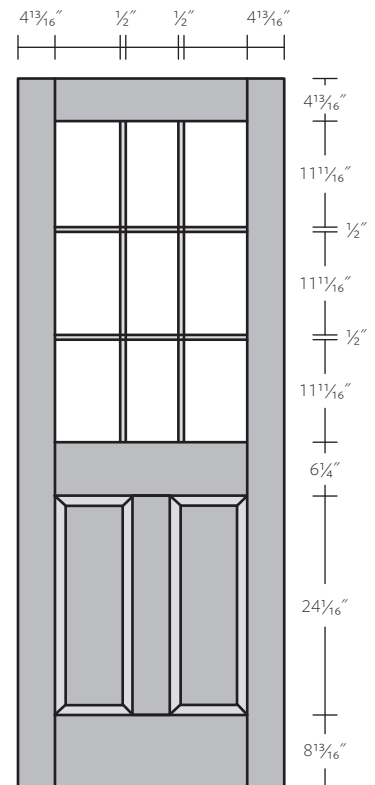

Two Panel Nine Light Glass Door

## Notes:

- Sommers Wood-N-Door specializes in custom entry doors. The styles and sizes shown here are only examples of some standard styles and sizes. Arched top doors, double doors, sidelights, and other specialty styles are available.
- Entry doors are generally sold as pre-hung units unless specified otherwise.

## Frame Profiles

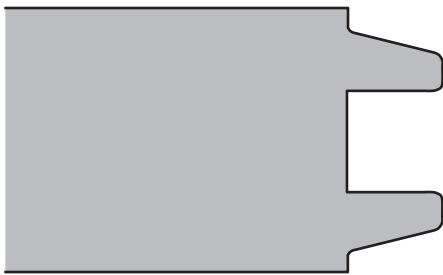

SWD 362 | Frame Profile

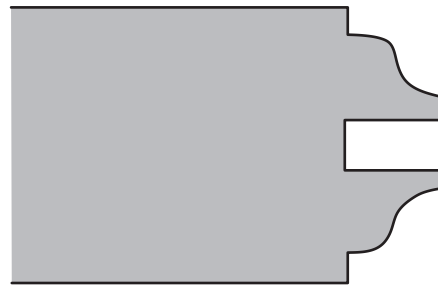

SWD 364 | Frame Profile

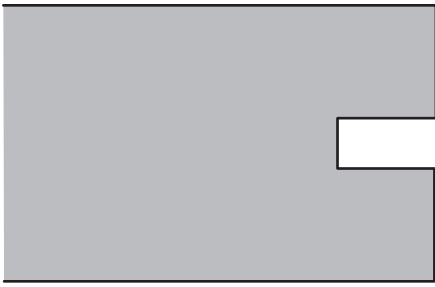

SWD 365 | Frame Profile

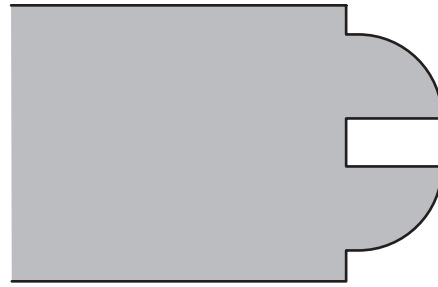

SWD 366 | Frame Profile

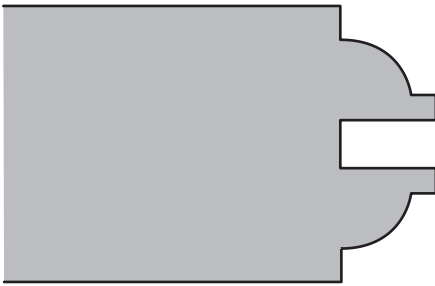

SWD 367 | Frame Profile

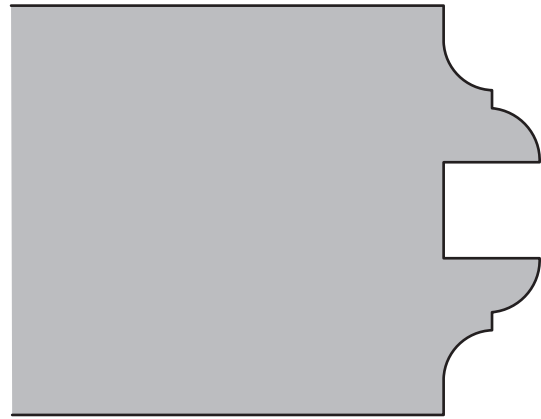

SWD 369 | Frame Profile

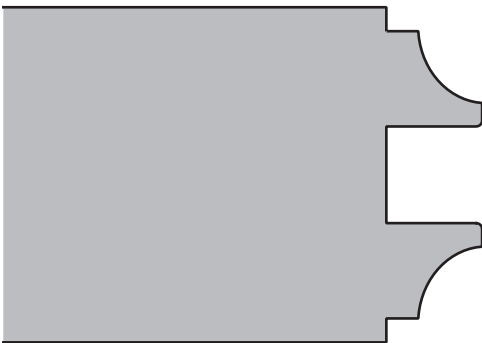

SWD 380 | Frame Profile

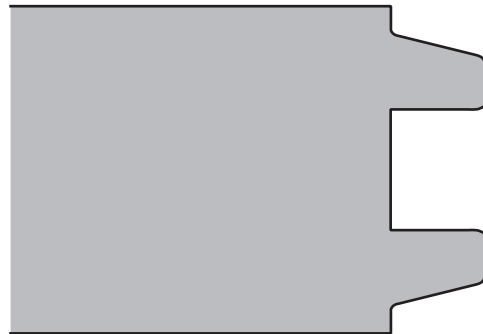

SWD 382 | Frame Profile

### Notes:

- SWD 364, SWD 365, & SWD 367 can be made with a 1/2" groove for thicker doors.
- SWD 365 can be used with applied moldings for other frame profile options. See SWD Trim Catalog Section 3 for other profiles.

# Panel Profiles

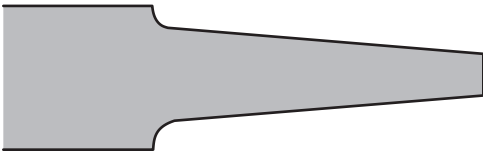

SWD 477 | Panel Profile

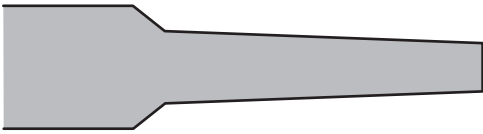

SWD 479 | Panel Profile

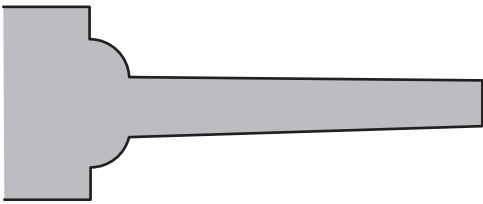

SWD 480 | Panel Profile



SWD 483 | Panel Profile

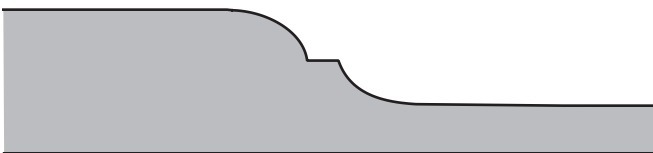

SWD 484 | Panel Profile

## Note:

- For more panel profile options, see pages 296-297.